

PAPER • OPEN ACCESS

Experimental investigation of flow and heat transfer in a channel with dimpled plate

To cite this article: Josephine Oluwaremilekun Oluyale *et al* 2019 *J. Phys.: Conf. Ser.* **1378** 022034

View the [article online](#) for updates and enhancements.

UNIVERSITY OF IBADAN LIBRARY



IOP | ebooks™

Bringing you innovative digital publishing with leading voices to create your essential collection of books in STEM research.

Start exploring the collection - download the first chapter of every title for free.

Experimental investigation of flow and heat transfer in a channel with dimpled plate

Josephine Oluwaremilekun Oluyale¹, Moses Omolayo Petinrin¹, Adeyinka Ayoade Adegbola², Felix Adedayo Ishola^{3,*}

¹Department of Mechanical Engineering, University of Ibadan, Ibadan, Nigeria

²Department of Mechanical Engineering, Ladoko Akintola University of Technology, Ogbomoso, Nigeria

³Department of Mechanical Engineering, Covenant University, Ota, Nigeria

*Corresponding author: felix.ishola@covenantuniversity.edu.ng

Abstract

This study presents the experimental investigation on the effect of dimpled arrangements on flow and heat transfer characteristics. Three plate surfaces were prepared (smooth, evenly distributed spherical dimples and unevenly distributed spherical dimples) and were placed successively in a channel. The unevenly distributed dimpled plate had the same dimple density with the evenly distributed dimpled plate but had varying transverse pitches to concentrate the dimples at mid-plate in flow direction. Data obtained from the experiment were analysed to determine the performance of each dimpled plate channel. It was observed that the average Nusselt number due to the heat interaction with the air-flow increases with the Reynolds number. The evenly and unevenly dimple plate channels had respectively, 75.7% and 91.8% increase in Nusselt number over the smooth channel. The flow friction factors of the evenly and unevenly dimple plate channels were merely more than that of smooth plate channel by 0.59% and 0.67%, respectively. Thus, the unevenly dimple plate channel had the highest overall thermal-hydraulic performance, followed by the evenly dimple plate channel.

Keywords: surface enhancement, unevenly distributed dimples, heat transfer characteristic, friction factor, Nusselt number, thermal performance.

1. Introduction

The growing interest of improving on the thermal efficiency of heat transfer equipment without compromising their energy requirement has left many researchers to continuous search for effective methods and ways in which heat can be transferred [1]. Its importance is found in many application areas such as heat exchangers, cooling of electronic components, gas turbines, microfluidic passages and in biomedical devices [2]. Improved performance has been achieved either by surface vibration, fluid vibration, or the surface is enhanced and made to have special features in order to increase heat flow, or adopting both methods [3]. Surfaces enhanced with ribs, fins, dimples and obstacles attached to surfaces, spirals, threads, grooves among others have been found to generally increase convective heat flow and transfer [4-6]. Dimpled surfaces have been reported to have an insignificant progressive drop in pressure towards the lee-ward side of flow because there is no pressure drag due to protuberances to disturb flow, instead, the dimples act as vortex structures creating an augmentation in fluid flow hence, enhancing heat transfer [6-7].

In 1971, Kueth investigated the use of dimpled surface for heat transfer enhancement for the first time. The density of dimples on the surface was varied and it was observed that heat augmentation



increased as the number of dimples on the surface increase [8]. Garcia et al. [9] studied the thermohydraulic characteristics of corrugated tubes, wire coils and dimpled tubes based on their artificial roughness. They observed that it greatly affected the pressure drop than the heat transfer enhancement. The study recommended the use Reynolds numbers below 200 for plain tubes. Wire coils were recommended for Reynolds numbers less than 2000 while corrugated tubes are preferable to wire coils in the range above 2000.

Chen et al. [10] investigated the thermal enhancement of a coaxial tube heat exchanger with dimpled inner tube. At constant Reynolds number, increase in heat transfer over the plain inner tube ranged from 15% to 137% while it was from 15% to 84% at the same pumping power. Studies have also shown that arrangement, diameter, shape and depth of dimples have notable effect on the heat transfer characteristics. Patil and Deshmukh [11] also performed the numerical analysis on plain, inline and staggered almond shape dimpled tubes, their results showed that there was more improvement in heat transfer in the staggered arrangement than the inline arrangement while the plain tube with the low heat transfer exhibited low pressure drop. Also, the staggered dimple tube gave the best performance.

Apet and Borse [12] conducted experimental examinations of forced convection heat transfer on dimpled tubes of different diameters and depths. They were able to conclude their research that dimpled tubes with smaller depths and diameters showed better heat transfer rate. Akthar et al. [13] examined natural convection heat transfer via circular dimpled plates. The results obtained lead to a significant improvement in the heat transfer at the surface of the dimpled plate.

Mahmood et al. [14] employed the flow visualisation technique to study structure of surface flow above dimpled surfaces. The authors observed periodic and continuous detachment of the primary vortex pair from the central part of the depression and the secondary vortex pair from the edges of the depression in the sense of span. In the experimental analysis conducted by Leontiev et al. [5] to establish the heat transfer performance of surfaces with six different dimple shapes: spherical, teardrop, oval, inverted teardrop, spherical dimples with rounded edges and dimples obtained by milling a sphere along an arc. The teardrop dimple was found to have the highest heat transfer coefficient, while the rounded-edges had the highest heat-hydraulic efficiency.

Hwang et al. [15] studied the thermal performance of a rectangular channel with pattern arrangement of spherical dimples and protrusions along its surface. It was observed that the coefficient of heat transfer was very high in the case of the arrangement of double-walled protrusions for its high flow mixing while the channel with double protrusion wall exhibited a higher pressure drop. Burgess and Ligrani [16] showcased the influence of dimple depth on Nusselt number and indicated that Nusselt number and friction increased as the depth of dimple increased.

Patel and Borse [8] conducted experimental studies on forced convection heat transfer at the dimpled surface. They observed that the staggered dimple arrangement exhibited greater Nusselt number than that of the inline arrangement when subjected to the same operating conditions. Vorayos et al. [6] investigated heat flow and transfer over dimpled surfaces with inline and staggered arrangements with varying pitch ratios. An outstanding augmentation observed at $S_T/S_L=1.33$ for inline arrangement and for staggered arrangement, the best performance was observed at S_T/S_L , lower than 2.0.

Thus, the studies have shown that surfaces with staggered arrangement of dimples exhibits better thermal performance than a surface with inline arranged dimples. However, it is rare in literature studies on performance of uneven distribution of dimples in staggered arrangement. Therefore, this research work would investigate the thermal and hydraulic characteristics of staggered dimple arrangement with unequal transverse pitches on a plate within a channel. This would have denser distribution of dimples at the mid-plate in flow direction and its performance would be compared with evenly distributed dimpled plate and smooth plate channels.

2. Experimental Details

2.1 Dimple arrangement on test plates

Three plates were used in the course of the experiment and each was made of mild steel of 220mm in length, 140mm width and 10mm thickness. As depicted in Fig. 1, eleven rows of spherical dimples with print diameter of 15 mm and depth of 5 mm were created on two of the plates in the stream-wise direction having a longitudinal pitch of 19.5 mm. The dimples on one were evenly distributed with transverse pitch ratio of 1.5 while the other has unevenly staggered arrangement of dimples of varying transverse pitch ratios ranging from 1.3 to 1.7. The three mild steel plates are as shown in Fig. 2.

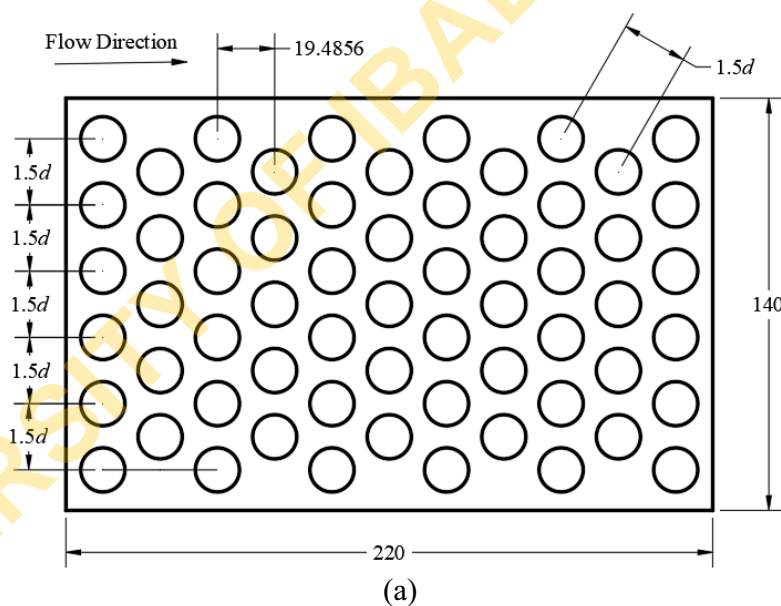

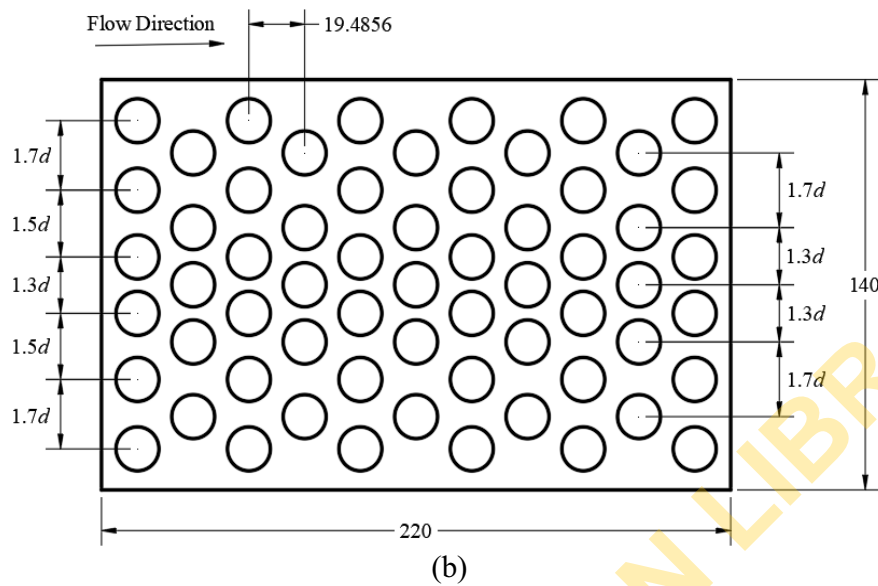

Fig. 1: Geometrical dimensions of the plates with (a) evenly distributed staggered dimples, and (b) unevenly distributed staggered dimples

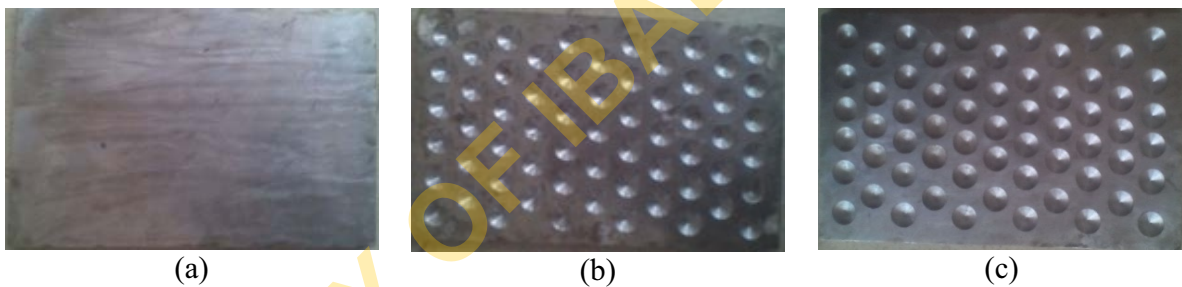

Fig. 2. The photographs of the (a) smooth plates, (b) evenly distributed staggered dimples, and (c) unevenly distributed staggered dimples

2.2 Experimental Setup

The experimental rig with channel air-flow cross-section of 35 mm x 140 mm and 1000 mm long, and its schematic diagram are as shown in Figs. 3 and 4, respectively. The closed channel was fabricated from mild steel angle bars and plywood. The complete setup comprises of a 1 hp blower, a 400 W heating element, a digital thermometer, a digital differential manometer and a Pitot tube. The blower with a variable speed control unit was installed to supply air and alter its velocities of flow through the test chamber. The heating element was installed inside a compartment fabricated at the base of the channel to heat the test plate above it. It was lagged on the lower-side for better concentration to the plate. Four K-type thermocouples ($\pm 0.16\%$ uncertainty) were connected to the thermometer to take the temperature readings and were installed at test locations: one at upstream the test plate; one downstream the test plate, almost at the tunnel exit; and the remaining two were fixed on surface of the test plate at both ends. The manometer was used to measure the pressure drop of air through the channel. The precision and accuracy of the manometer is ± 0.2 and ± 0.1 , respectively. The pitot tube fixed at the upstream the tube bundles was employed to take the air velocity reading. To ensure steady air pressure drop and temperature readings at downstream

the tube bundle, their probes were positioned far away from the tube bundle towards the exit of the channel.



Fig 3: The Experimental rig

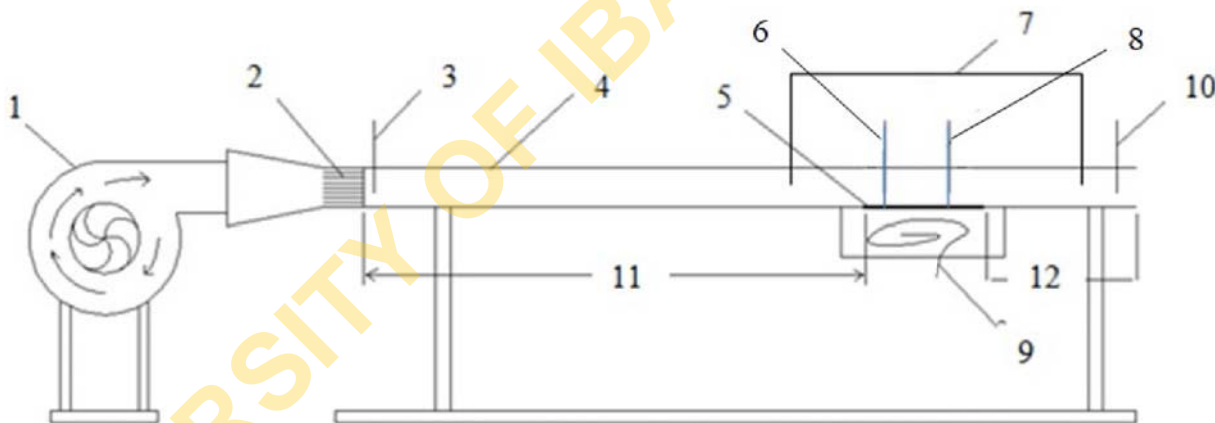

Fig. 4: Schematic diagram of experimental setup

where: 1. blower 2. straighteners. 3. 1st thermocouple. 4. air-flow channel. 5. test plate. 6. 2nd thermocouple 7. digital manometer. 8. 3rd thermocouple. 9. heating element. 10. 4th thermocouple. 11. entry length. 12. exit length.

2.3 Experimental Procedure

Leakages that could affect the experimental results were checked before taking any reading. This was done by supplying air from the blower and appropriate corrections were made where necessary. As depicted in Fig. 4, the air flow through the channel was again supplied from the blower and electricity supply was activated on the heater. All readings were taking when the average readout temperature on the test plates was approximately 60°C . In each run, the inlet air flow velocity through the channel was varied from 3.97 to 5.80 m/s. In order to ensure reliability

of measurements, this operation was repeatedly carried out for each inlet air flow velocity. Also, this experiment was conducted for each of the test plates in turn.

3. Data reduction

The experimental data obtained were further analysed to find the flow and thermal characteristic of the channel as being affected by each of the test plates. The heat transferred to the due to change of difference in temperature between the downstream and upstream of the test plate is

$$Q = \dot{m}c_p (T_{out} - T_{in}) \quad (1)$$

Therefore, the convective heat transfer coefficient of the dimpled plate channel is defined as

$$h = \frac{Q}{A_s \Delta T_{LM}} \quad (2)$$

Where the log mean temperature difference between the heated test plate and the cool air from the blower is given as

$$\Delta T_{LM} = \frac{(T_s - T_{in}) - (T_s - T_{out})}{\ln \frac{(T_s - T_{in})}{(T_s - T_{out})}} \quad (3)$$

and the surface area of the plate is

$$A_s = Lw \quad (4)$$

Thus, the average Nusselt number is calculated from

$$Nu = \frac{hd_h}{k} \quad (5)$$

and d_h is the hydraulic diameter of the closed channel, obtained from

$$d_h = \frac{2wH}{w + H} \quad (6)$$

The air flow Reynolds number is estimated to be

$$Re = \frac{\rho v d_h}{\mu} \quad (7)$$

The friction factor of the flow across the channel is determined as

$$f = \frac{2\Delta p}{(L/d_h)\rho v^2} \quad (8)$$

The thermal hydraulic performance factor, PF of the dimpled plate channel was calculated based on the constant pumping power condition by considering heat transfer augmentation and the pressure loss in the channel [17]; then we have

$$PF = \frac{Nu/Nu_0}{f/f_0} \quad (9)$$

The Nu_0 and f_0 represent the Nusselt number and friction factor of the smooth plate channel.

The thermal performance, TP of each dimpled plate channel in comparison with the smooth plate channel was also described in terms of the actual surface area exposed to the air flow and was estimated as the normalised Nusselt number to active surface area ratio of the dimpled surface to the smooth surface [18], which is given as

$$TP = \frac{Nu/Nu_0}{A/A_0} \quad (10)$$

4. Results and Discussion

The average Nusselt number from the thermal interaction in all the plate channels for a range of Reynolds number are as presented in Fig. 5. It can be seen that the Nusselt number increases with increase in Reynolds number. The unevenly staggered dimpled plate channel demonstrated the highest heat transfer performance with 91.8% increase over the smooth plate channel while the evenly staggered dimpled plate channel increased with 75.7% over the range of Reynolds number. For fully developed flow through each of the channels, the plate is exposed to higher velocity at the middle than its edges at the corners of the channel, hence the outstanding thermal characteristics of the unevenly staggered dimpled plate channel for higher concentration of dimples at the mid-plate. As indicated in Fig. 6 for the normalized average Nusselt number, this is the ratio of the average Nusselt number of the dimpled plate channel to that of the smooth channel. The Nusselt number ratios of the dimpled channels are higher at lower Reynolds number than the higher Reynolds number. The heat transfer augmentation of dimpled surfaces over the smooth surface ranged from 1.29 – 2.29.

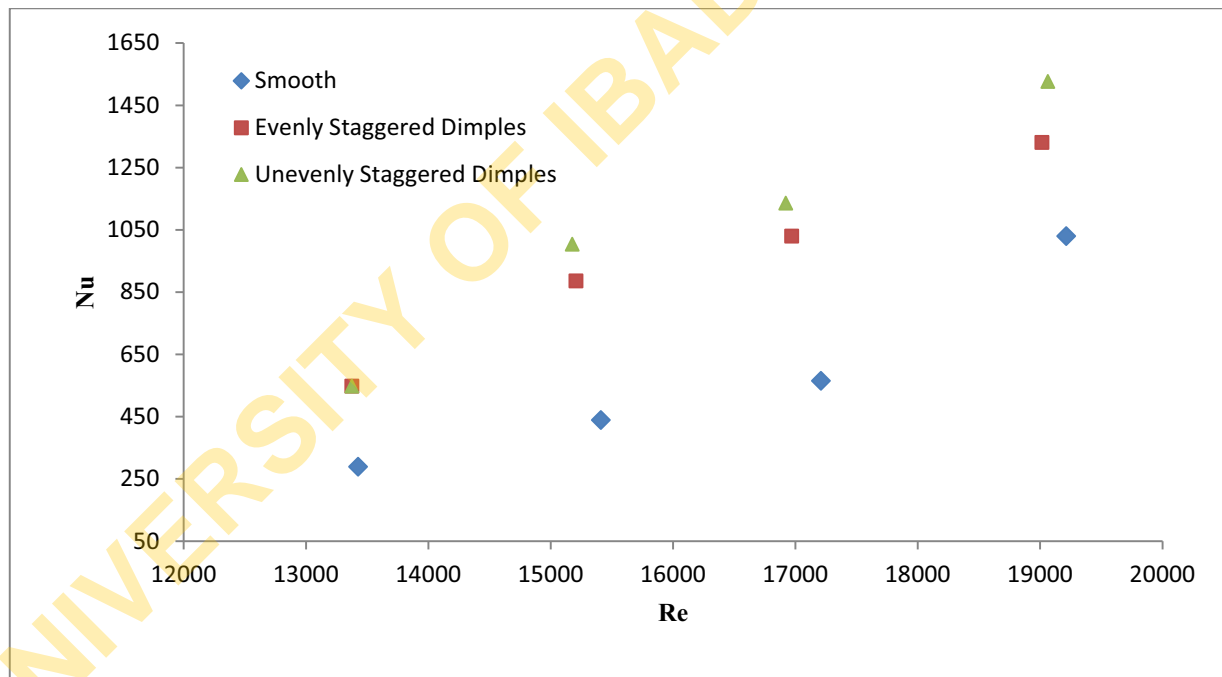

Fig. 5: The average Nusselt number versus Reynolds number

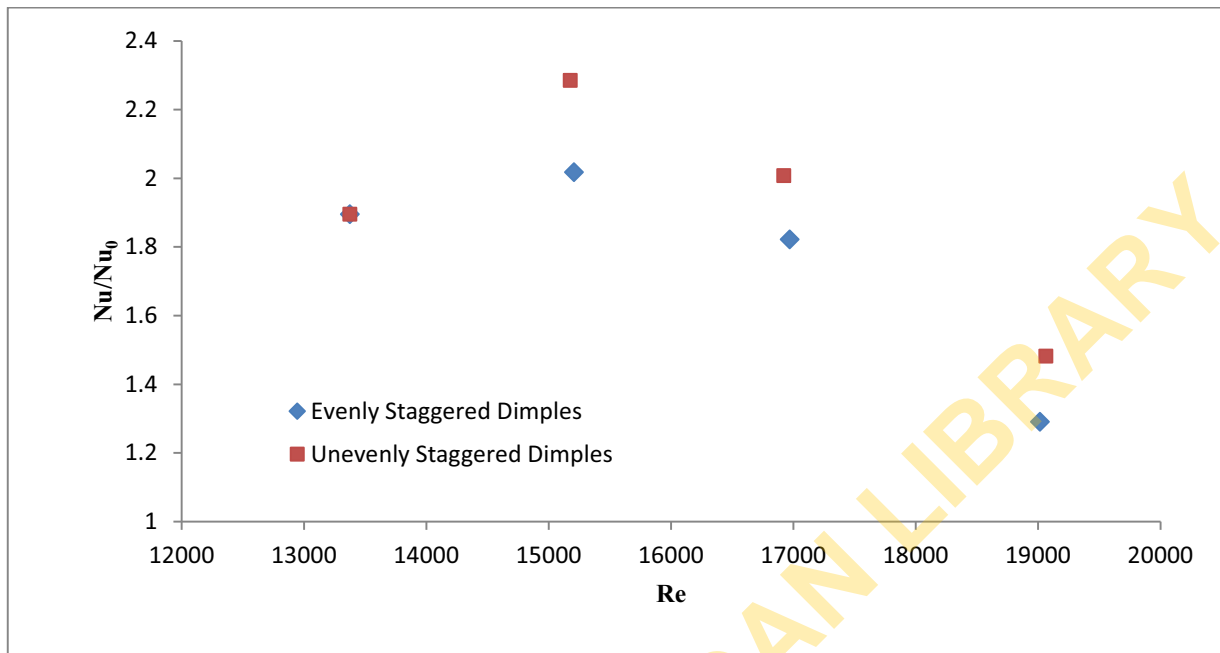

Fig. 6: The normalised Nusselt numbers at different Reynolds numbers

The friction characteristics of the flow through the recessed plate channels with respect to the Reynolds number are illustrated in Fig. 7, respectively. The increase is almost insignificant and is considered low because no flow enters the river [19]. Figure 8 shows the normalized friction factor of smooth channel indented channels between 1.002 and 1.010. The tendency of the normalized friction factor is similar to that of Fig. 12 due to the almost constant friction factor obtained for the smooth channel in the Reynolds number range.

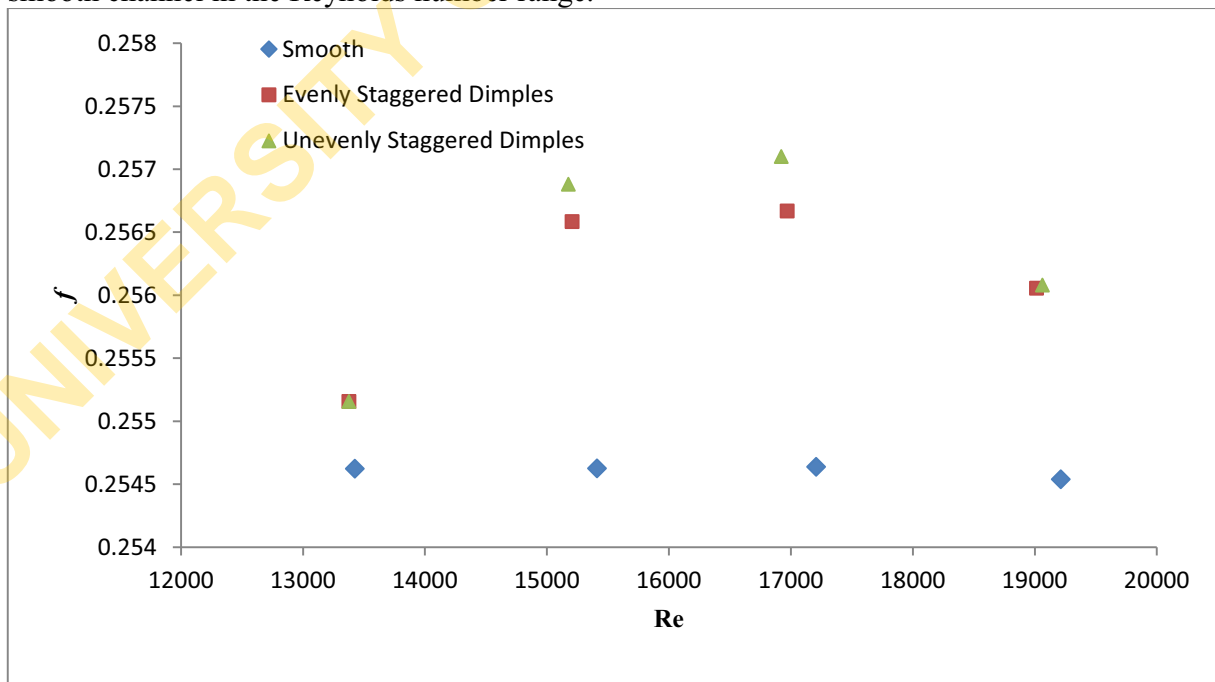

Fig. 7: The flow friction factor versus Reynolds number

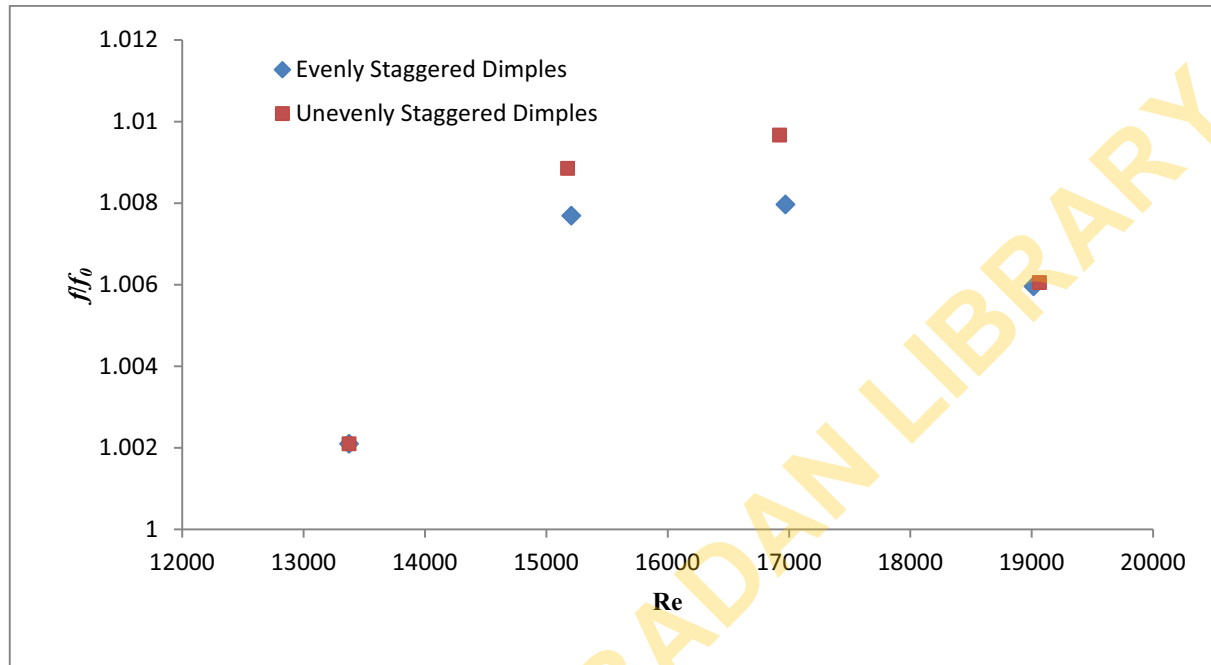

Fig. 8: The normalised friction factors at different Reynolds numbers

The overall thermal-hydraulic performance of the dimpled plate channels is presented in Fig. 9. Evidently from this figure, the overall performance exhibited by the unevenly and evenly staggered dimpled plate channels are averagely higher than that of smooth plate channel with 90.5% and 74.6%, respectively. Thus, the performance of the dimpled channels could be attributed to turbulent mixing promoted by the presence of vortex structure in dimple cavities [18]. Also presented in Fig. 10 is the normalised Nusselt number to active surface area ratio of the dimpled surface to the smooth surface. It can be clearly seen from the figure that the additional surface area created by the dimpled surface does not affect their thermal performance. The thermal performance is enhanced by 57.3% and 71.8% for the unevenly and evenly staggered dimpled plate channels, respectively.

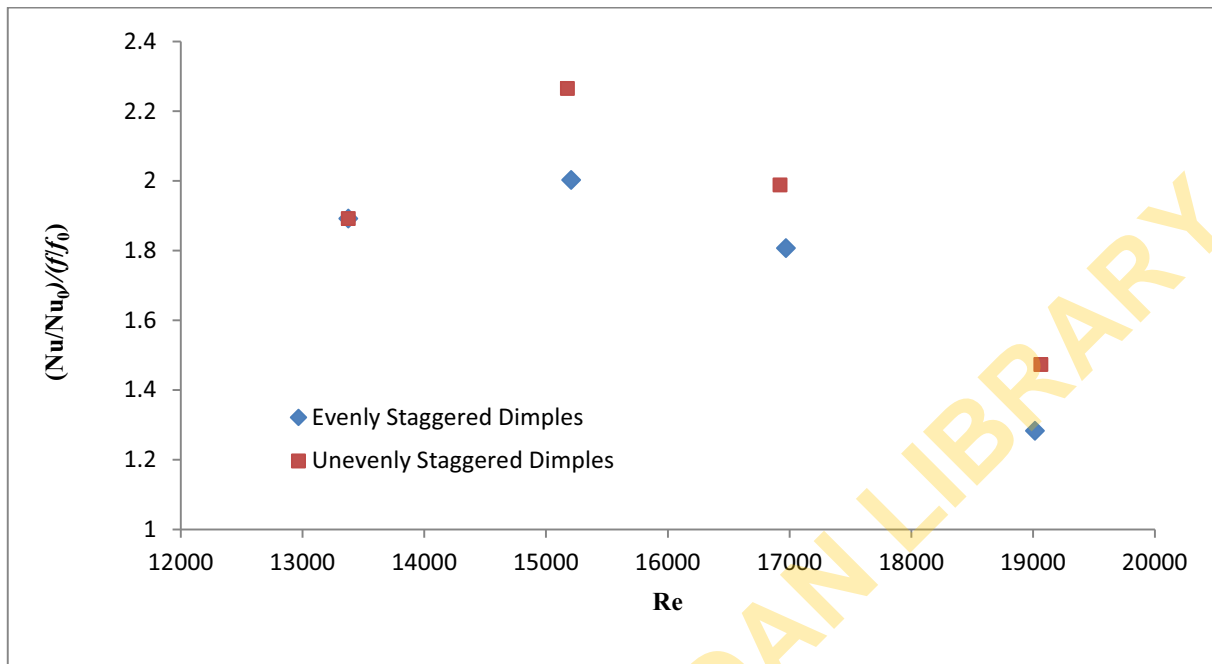

Fig. 9: The overall thermal-hydraulic performance of the dimpled channels

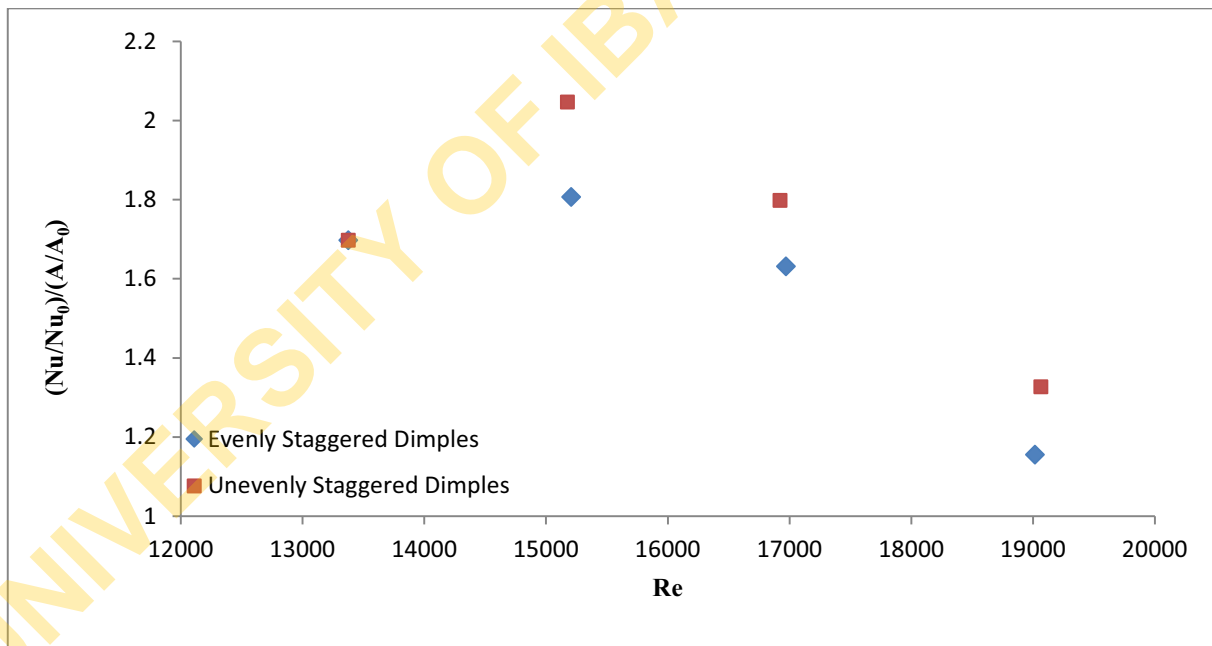

Fig. 10: The thermal performance of the dimpled channels

5. Conclusion

The experimental investigation of heat transfer enhancement and flow characteristic of three mild steel plates was successively carried out in a channel. The surface of one of the plates was smooth while the other two were arranged with evenly and unevenly distributed staggered dimples,

respectively. The study has indicated that the rate of heat flow between the plate surfaces and air flow through the channel increased with the flow rate or Reynolds number. The dimpled plate channels had higher Nusselt number than the smooth plate channel with 75.7% and 91.8% increase for the evenly and unevenly dimple plates, respectively. The friction factors of the evenly and unevenly dimpled plate channels only increased over the smooth plate channel by 0.59% and 0.67%, respectively. The unevenly dimpled plate channel exhibited better overall thermal-hydraulic performance, followed by the evenly dimpled plate channel. Hence, more spread of dimples at the mid-surface in flow direction have better enhancement capability of thermal efficiency without appreciable compensation for energy than even distribution of dimpled surface.

Nomenclature

Abbreviations and Symbols

A	Tube Cross-Sectional Area (m^2)
c_p	Specific Heat Capacity at Constant Pressure (J/kgK)
d_h	Hydraulic diameter (m)
f	Friction factor
k	Thermal Conductivity (W/mK)
L	Plate Length (m)
Re	Reynolds Number
Δp	Pressure Drop (Pa)
h	Heat Transfer Coefficient (W/m^2K)
H	Channel height (m)
\dot{m}	Mass flow rate (kg/s)
Nu	Nusselt Number
Q	Heat Transfer Rate (W)
T	Temperature (K)
v	Flow velocity (m/s)
w	Plate width (m)
ΔT_{LM}	Log Mean Temperature Difference

Greek Symbols

ρ	Density (kg/m^3)
--------	----------------------

Subscripts

in	Inlet
out	Outlet
s	Surface

References

- [1] Kamath, P., Paramashivaiah, M., Buksagamath, Rai, N., & Salian, S. N. (2016). An Experimental Study on Enhancement of Convective Heat Transfer over Dimpled Surface, *Journal of Mechanical Engineering and Automation*, 6(5A), 126-130.

- [2] Chen, Y., Chew, Y., & Khoo, B. (2012). Enhancement of heat transfer in turbulent channel flow over dimpled surface. *International Journal of Heat and Mass Transfer* , 55, 8100–8121.
- [3] Verma, S. R., Khanwalkar, P. M., & Kapatkar, V. N. (2015). A review on heat transfer augmentation for various dimpled geometries. *International Journal on Theroetical and Applied Research in Mechanical Engineering* , 4 (1), 59-64.
- [4] Fu, Z., Qian, Y., Zhou, X., Yan, Z., & Jiao, Y. (2017). A research of heat transfer enhancement of rectangular channel with dimples. *MATEC Web of Conferences*, doi: 10.1051/mateconf/201710004001.
- [5] Leontiev, A., Kiselev, N., Vinogradov, Y., Strongin, M., Zditovets, A., & Burtsev, S. (2017). Experimental investigation of heat transfer and drag on surfaces coated with dimples of different shape. *International Journal of Thermal Sciences* , 118, 152-167.
- [6] Vorayos, N., Katkhaw, N., Kiatsiriroat, T., & Nuntaphan, A. (2016). Heat transfer behavior of flat plate having spherical dimpled surfaces. *Case Study in Thermal Engineering* , 8, 370-377.
- [7] Kim, K. Y. & Choi, J. Y. (2007). Shape Optimization of a Dimpled Channel to Enhance Turbulent Heat Transfer. *Numerical Heat Transfer*, 901-915. <https://doi.org/10.1080/10407780500226571>.
- [8] Patel, I., & Borse, S. (2012). Experimental investigation of heat transfer enhancement over the dimpled surface. *International Journal of Engineering Science and Technology* , 4, 3666-3672.
- [9] Garcia, A., Solano, J. P., Vicente, P. G. & Viedma, A. (2012). The influence of artificial roughness shape on enhancement of heat transfer: Corrugated tubes, dimpled tubes and wire coils. *Applied Thermal Engineering*, 35, 196-201.
- [10] Chen, J., Muller-Steinhagen, H. & Duffy, G. G. (2001). Heat Transfer Enhancement In Dimpled Tubes. *Applied Thermal Engineering*, 21(5), 535-547.
- [11] Patil, P., & Deshmukh, P. (2014). Numerical study of flow and heat transfer in circular tubes with almond shaped dimple. *International Journal of Engineering Research and Technology*, 3(8), 21-29.
- [12] Apet, V., & Borse, S. L. (2015). Heat transfer enhancement in dimpled tube. *International Journal for Scientific Research & Development* , 3(3), 3192-3195.
- [13] Akthar, F., Kaladgi, A. R. & Dafedar, M. A. (2015). Heat Transfer Enhancement Using Dimpled Surfaces Under Natural Convection An Experimental Study, *Int. J. Mech. Eng. & Rob. Res.* , 1(4).
- [14] Mahmood, G. I., Hill, M. L., Ligrani, P. M., Nelson, D. L., Moon, H. K., & Glezer, B. (2001). Local Heat Transfer and Flow Structure on and above a Dimpled Surface Channel. *J. Turbomach* , 123 (1), 155.

- [15] Hwang, S., Kwon, H., & Cho, H. (2008). Heat transfer with dimple/protrusion arrays in a rectangular duct with a low Reynolds number range. *International Journal of Heat and Fluid Flow* , 29, 916–926.
- [16] Burgess, N. K., & Ligrani, P. M. (2005). Effect of dimpled depth on channel Nusselt numbers and friction factors. *J. Heat. Transf.* , 127 (1), 839-847.
- [17] Bayat, H., Lavasani, A., & Maarefdoost, T. (2014). Experimental study of thermal–hydraulic performance of cam-shaped tube bundle with staggered arrangement. *Energy Conversion and Management* , 85, 470-476.
- [18] Xie, G., Liu, J., Ligrani, P., & Zhang, W. (2013). Numerical Predictions of Heat Transfer and Flow Structure in a Square Cross-Section Channel with Various Non-Spherical Indentation Dimples. *Numerical Heat Transfer, Part A* , 64, 187–215.
- [19] Rao, Y., Feng, Y., Li, B., & Weigand, B. (2015). Experimental and Numerical Study of Heat Transfer and Flow Friction in Channels With Dimples of Different Shapes. *Journal of Heat Transfer* , 137(3).