

**PATHOGENICITY of *Heterodera sacchari* (LUC AND MERNY) AND  
ITS INTERACTION WITH *Botryodiplodia theobromae* (PAT) ON SOME  
NERICA RICE CULTIVARS**

**BY**

**LEONARD ITSEDE, AKPHEOKHAI**

**B. Sc. (Hons) Agric., M. Sc. (Phytopathology) Ibadan.**

**A Thesis in the Department of Crop Protection and Environmental Biology Submitted  
to the Faculty of Agriculture in partial fulfillment of the requirements for the Degree  
of**

**DOCTOR OF PHILOSOPHY**

**of the**

**UNIVERSITY OF IBADAN, NIGERIA**

**JUNE, 2013**

## ABSTRACT

The Cyst Nematode (CN), *Heterodera sacchari*, is an important pest that causes yield losses of upland rice. NERICA Rice (NR) is a widely-grown upland rice cultivar. *Botryodiplodia theobromae* (a rot fungus) exists in many agricultural lands and causes yield losses on crops. However, information on the pathogenicity and damage by CN on NR cultivars in Nigeria is scanty. Therefore, pathogenicity of CN on NR cultivars and its interaction with *Botryodiplodia theobromae* were investigated.

Twenty-four upland cultivars were screened for resistance to *H. sacchari* by inoculating three-week old seedlings with zero and 5000 eggs of *H. sacchari*. Cyst rating following standard procedure was used to determine resistance/susceptibility. Pathogenicity of *H. sacchari* was conducted to determine nematode damage on NR1, NR2, NR3, NR8 and NR14 cultivars in pot and field experiments in two cropping seasons. Three-week old seedlings of each cultivar were inoculated in pot experiment at zero, 5000 and 10000 eggs of *H. sacchari* per pot in four replicates in a 5X3 factorial using Randomized Complete Block Design (RCBD). The field trial was a split-plot experimental design with nematode-treatment as main plot and the five NERICA rice cultivars as sub-plots. Interaction between *H. sacchari* and *B. theobromae* on NR was investigated in pot and microplot experiments using standard procedures. Three-week old seedlings of NR1 were inoculated at zero or 5000 eggs of *H. sacchari* alone,  $5 \times 10^5$  spores  $\text{ml}^{-1}$  of *B. theobromae* alone and simultaneous inoculation of *H. sacchari* + *B. theobromae* per pot in four replicates in a RCBD. The same treatments were carried out for the seedlings in the microplots (50x50x75) cm. Plants were assessed for growth, yield and nematode-fungal damage. Root sections (14 $\mu\text{m}$ ) of NR from the interaction experiment were prepared for histopathology studies using standard procedures. Photomicrographs of cell structural integrity and damage were taken. Data were analyzed using descriptive statistics and ANOVA at  $p=0.05$ .

Twenty-one rice cultivars (seven improved *Oryza sativa* and 14 NR cultivars were rated susceptible), NR6 and NR8 were rated moderately resistant and CG14 was most resistant. *Heterodera sacchari* significantly reduced NR growth by 41.8%, root weight by 55.4% and yield by 67.7%. Interaction between *H. sacchari* and *B. theobromae* significantly reduced NR growth by 58.8% - 67.3%, root weight by 63.4% - 70.4% and

yield by 62.2% - 75.4%, compared to single inoculation with *H. sacchari* or *B. theobromae*. *Heterodera sacchari* infection caused cellular disorganization, compression and disintegration. Syncytia with seven nuclei, were formed close to nematode head seven days after inoculation (DAI). Both CN and *B. theobromae* developed and reproduced when present on same root tissue. Fruiting bodies of *B. theobromae* enlarged and ruptured cortical cells and epidermal layer of root during ascospore discharge 7 DAI. Infection of both pathogens revealed dark necrotic regions, cellular compression, disorganization and disintegration. Syncytium was established by the nematode in presence of the fungus 9 DAI.

*Heterodera sacchari* caused significant damage and yield reduction on NERICA Rice cultivars and its interaction with *Botryodiplodia theobromae*, synergistically reduced growth and yield of rice. However, CG14 was most resistant.

Keywords: NERICA rice, *Heterodera sacchari*, *Botryodiplodia theobromae*, Pathogenicity, Histopathology.

Word count: 500

## ACKNOWLEDGEMENTS

I am very much indebted to my supervisor, Prof. B. Fawole who carefully guided me through this work. He was able to bring out the research potentials and qualities in me, and ability to do independent work. He was never tired of my many questions and requests. I thank him particularly for his patience, understanding, contributions, constructive criticisms and encouragement. He's always there for me. I am greatly indebted to Dr. A.O. Claudius-Cole, for her numerous assistance, suggestions and advise in the course of running this programme. She has indeed trained me like a teacher, a mother and a friend. She is indeed a wonderful mentor. I can never forget her. I pray that God will grant her the desires of her heart. Amen. I am very grateful to members of my supervisory committee: Prof. G.I Atiri, Prof. B. Ikotun and Dr. A.O. Claudius-Cole who, together with my Supervisor, offered useful suggestions and valuable criticisms in the course of this training and for finding time to go through and correct the draft thesis. My gratitude goes to all the members of the Nematology Research Laboratory Unit, International Institute of Tropical Agriculture (IITA), Ibadan, for their support and cooperation during the course of my project, I also appreciate Dr. Danny Coyne for allowing me to use the laboratory equipment, the screenhouse and other materials in the laboratory. I will also use this medium to thank Dr. Francis Nwilene and Mr. Kehinde of Africa Rice Center (formerly known as WARDA) for their support by supplying all the rice seeds and *H. sacchari*-infested field used for this study. Immense thanks go to my colleagues, Mrs. Aminu-Taiwo, Messrs Debo Tanimola, Edward Oyekanmi, Thomas Agaba and Rotimi Akinlesi, Omena Ojuederie, Adebisi Olanrewaju, Bello Tesleem, Ajibode Modupe, Elohor Aziza, Odom Oluchi, Mrs. Dupe Abidemi and Mrs. Wumi Adewuyi (IITA), Drs. Bukky Bamkefa, Oluremi Osunlola, Moye Oyetunji e.t.c for their words of encouragement and useful contributions during the course of this work. I am grateful to my parents, Mr. and Mrs. Anthony M. Akpheokhai for their prayers, contributions and invaluable support. They also paid the price to give me a sound education. I am greatly indebted to my wife Heffai Deborah, the Queen of my Heart and my endless love, for her constant prayers, encouragement, love, kindness, understanding and care. She was home away from home so that I could concentrate during the course of this study. I pray that God, in His infinite mercies, will protect and guide her, and make

all our dreams and aspirations a reality. Amen. I thank my children Albert, Veron and Anthony for enduring my stay away from home in the course of this work. I also thank my brothers and sister, Nathaniel, Elias, Theophilus, Faustina and my little niece, Doreen. I thank you all. Finally, I give glory to God Almighty who made it possible for the successful take-off of this programme a reality. Unto the King of kings, I give all glory, honour and adoration forever and ever. Amen.

## **CERTIFICATION**

I certify that this work was carried out by Leonard Itsede AKPHEOKHAI of the Department of Crop Protection and Environmental Biology, University of Ibadan, Ibadan, Nigeria.

---

### **SUPERVISOR**

**BAMIDELE FAWOLE**  
**B.Sc. (Agric.) (Ibadan); M.S., Ph.D. (Cornell)**  
**Professor of Nematology,**  
**Department of Crop Protection and**  
**Environmental Biology, University of Ibadan,**  
**Ibadan.**

## **DEDICATION**

This work is dedicated to the Glory of God Almighty for seeing me through this phase of the programme, I thank Him for His numerous mercies and absolute faithfulness. Also, to my wife Deborah and children: Albert, Anthony and Veron who endured lonely nights while I was away to run this programme.

<b>TABLE OF CONTENTS</b>	<b>PAGE</b>
<b>ABSTRACT</b>	ii
<b>ACKNOWLEDGEMENTS</b>	iv
<b>CERTIFICATION</b>	vi
<b>DEDICATION</b>	vii
<b>TABLE OF CONTENTS</b>	viii
<b>LIST OF TABLES</b>	xii
<b>LIST OF PLATES</b>	xvi
<b>LIST OF FIGURES</b>	xix
<b>1.0 CHAPTER ONE: INTRODUCTION</b>	1
1.1 Origin, distribution and botanical description of rice	1
<b>2.0 CHAPTER TWO: LITERATURE REVIEW</b>	5
2.1 Rice production and consumption in Sub-Saharan Africa (SSA)	4
2.2 Agronomic procedures in upland rice production	5
2.3 Uses and nutritional composition of rice	7
2.4 Nematode constraints to rice production	8
2.5 Importance of nematodes in rice production	9
2.6 Damage and symptoms expression due to cyst nematode on rice	9
2.7 The cyst nematode- <i>Heterodera</i> species: Taxonomy, Description, Development and Life cycle	10
2.8 Other nematodes associated with rice	11
2.9 Host-parasite relationships of plant-parasitic nematodes on crops	13
2.10 Fungal pathogens associated with rice	15
2.11 Taxonomy and importance of <i>Botryodiplodia theobromae</i>	17
2.12 Importance of nematode-fungi interactions	18
<b>3.0 CHAPTER THREE: MATERIALS AND METHODS</b>	20
3.1 Soil sterilization	20



3.2	Extraction of cyst nematodes from soil	20
3.3	Extraction of eggs from <i>Heterodera sacchari</i> cysts	20
3.4	Establishment and multiplication of <i>Heterodera sacchari</i> on OS6 rice cultivar	22
3.5	Preparation of inoculum for the experiments	22
3.6	Estimation of <i>Heterodeta sacchari</i> inoculum	22
3.7	Preparation of culture media	24
3.8	Collection and surface sterilization of infected rice root	24
3.9	Isolation of <i>Botryodiplodia theobromae</i> from fungi culture	24
3.10	Estimation of <i>Botryodiplodia theobromae</i> spores	25
3.11	Extraction of <i>Heterodera sacchari</i> second-stage juveniles (J2) from root and soil using modified Baermann extraction technique	25
3.12	Data analyses	27
3.13	Experiment 1: Screening of Twenty-five Rice cultivars for resistance to <i>Heterodera sacchari</i>	27
3.14	Experiment 2: Pathogenicity of <i>Heterodera sacchari</i> on growth and yield of rice	30
3.14.1	Field experiment	32
3.15	Experiment 3: Studies of the relationship between <i>Heterodera sacchari</i> and <i>Botryodiplodia theobromae</i> on growth and yield of rice.	35
3.15.1	Pot experiment	35
3.15.2	Microplot experiment	36
3.16	Experiment 4: Histopathology of NERICA rice roots infected by <i>Heterodera sacchari</i>	38
3.17	Experiment 5: Histopathology of NERICA rice roots infected by <i>Heterodera sacchari</i> and <i>Botryodiplodia theobromae</i> in various inoculation sequence	41

4.0	<b>CHAPTER FOUR: RESULTS</b>	43
4.1	Screening of rice cultivar for resistance to cyst nematode <i>Heterodera sacchari</i>	43
4.2	Pathogenicity of <i>Heterodera sacchari</i> on NERICA rice in pots	45
4.2.1	Effects of various inoculum densities of <i>H. sacchari</i> on vegetative growth of NERICA rice from inoculation to eleventh week	45
4.2.2	Effects of <i>Heterodera sacchari</i> population densities on growth and yield of five NERICA rice cultivars	48
4.2.3	Reproduction of <i>Heterodera sacchari</i> at different population densities on five NERICA rice cultivars	63
4.3	Pathogenicity of <i>Heterodera sacchari</i> on NERICA rice in the field	70
4.3.1	Effect of <i>Heterodera sacchari</i> on growth, yield and nematode reproduction of NERICA rice cultivars	70
4.3.2	Response of five NERICA rice cultivars to <i>Heterodera sacchari</i> infection in the field	70
4.4	Effect of interaction between <i>Heterodera sacchari</i> and <i>Botryodiplodia theobromae</i> on growth, yield and nematode reproduction on NERICA rice cultivars (Pot)	90
4.4.1	Effects of interaction between <i>Heterodera sacchari</i> and <i>Botryodiplodia theobromae</i> on growth, yield and nematode reproduction on two NERICA rice cultivars in pot.	96
4.4.2	Interaction between <i>Heterodera sacchari</i> and <i>Botryodiplodia theobromae</i> on growth, yield and nematode reproduction on NERICA rice cultivars (Microplot)	106
4.4.3	Response of NERICA 1 and NERICA 2 rice cultivars to the interaction between <i>Heterodera sacchari</i> and <i>Botryodiplodia theobromae</i> at 11 weeks after inoculation (harvest) in the microplot	116
4.5	Host –parasite relations of <i>Heterodera sacchari</i> in NERICA 1 rice cultivars	124
4.6	Histopathology details of NERICA 1 rice root infected with <i>Heterodera sacchari</i> and <i>Botryodiplodia theobromae</i>	125

5.0	<b>CHAPTER FIVE: DISCUSSION AND CONCLUSION</b>	134
5.1	<b>Summary and Recommendations</b>	150
	<b>REFERENCES</b>	154
	<b>APPENDIX</b>	168
1	Damage score of <i>Heterodera sacchari</i> on rice roots in relation to percentage damage.	168

## LIST OF TABLES

TABLE	PAGE
3.1 Cyst production rating scale	29
4.1 Reproduction of <i>Heterodera sacchari</i> on 24 cultivars of rice 60 days after inoculation	44
4.2 Effect of <i>Heterodera sacchari</i> on fresh root and shoot weights of rice 60 days after inoculation	46
4.3 Reproduction of <i>Heterodera sacchari</i> at different population densities on five NERICA rice cultivars (first trial)	67
4.4 Reproduction of <i>Heterodera sacchari</i> at different population densities on five NERICA rice cultivars (second trial)	68
4.5 Reproduction of <i>Heterodera sacchari</i> on five NERICA rice cultivars in the field	89
4.6 Effects of <i>Heterodera sacchari</i> and <i>Botryodiplodia theobromae</i> interaction on growth and yield of NERICA rice cultivars	95
4.7 Effects of <i>H. sacchari</i> and <i>B. theobromae</i> interaction on disease index and Nematode reproduction on NERICA rice cultivars	97
4.8 Effects of <i>Heterodera sacchari</i> and <i>Botryodiplodia theobromae</i> interaction on growth and yield parameters of two NERICA rice cultivars (first trial)	102
4.9 Effects of <i>Heterodera sacchari</i> and <i>Botryodiplodia theobromae</i> interaction on growth and yield parameters of two NERICA rice cultivars (second trial)	103
4.10 Effects of interaction between <i>Heterodera sacchari</i> and <i>Botryodiplodia theobromae</i> on disease index and nematode reproduction on two NERICA rice cultivars	105
4.11 Effects of interaction between <i>Heterodera sacchari</i> and <i>Botryodiplodia theobromae</i> on growth and yield of NERICA rice cultivars (microplots)	112
4.12 Effects of interaction between <i>Heterodera sacchari</i> and <i>Botryodiplodia theobromae</i> on disease index and nematode reproduction on NERICA rice cultivars in microplot	115
4.13 Effects of interaction between <i>Heterodera sacchari</i> and <i>Botryodiplodia theobromae</i> on growth and yield parameters of NERICA 1 and NERICA 2 rice cultivars	121

4.14	Effects of interaction between <i>Heterodera sacchari</i> and <i>Botryodiplodia theobromae</i> on disease index and nematode reproduction on NERICA 1 and NERICA 2 rice cultivars	123
------	---	-----

<b>PLATE</b>	<b>LIST OF PLATES</b>	<b>PAGE</b>
3.1	Brown cysts and white females of <i>Heterodera sacchari</i> extracted from soil of an infested rice field at Ikenne, Ogun state.	21
3.2	White females (WF) of <i>Heterodera sacchari</i> on susceptible OS6 rice root	23
3.3	Petri-dishes with <i>Botryodiplodia theobromae</i> after seven days and after four weeks	26
4.1	Effect of different inoculum densities of <i>Heterodera sacchari</i> on root development of NERICA rice at 11 weeks after inoculation	60
4.2	Interaction between <i>Heterodera sacchari</i> and <i>Botryodiplodia theobromae</i> on NERICA 1 rice at four weeks after inoculation	107
4.3	Effects of <i>Heterodera sacchari</i> and <i>Botryodiplodia theobromae</i> interaction on root mass of NERICA 1 rice at 11 weeks after inoculation	114
4.4	Healthy and infected root sections of NERICA 1 rice	127
4.4.1	Developing <i>Heterodera sacchari</i> and syncytium inside NERICA 1 rice root	128
4.4.2	Longitudinal sections of NERICA 1 rice root with compressed, necrotic and disorganized cellular integrity	129
4.4.3	Infected NERICA 1 rice root with emerging adult white female nematode with eggs (24 DAI) and emerged cyst (29 DAI)	130
4.5	Longitudinal Sections (LS) of NERICA 1 rice root infected with <i>Botryodiplodia theobromae</i>	131
4.5.1	Longitudinal Sections (LS) of NERICA 1 rice roots infected with <i>Botryodiplodia theobromae</i> and <i>Heterodera sacchari</i>	132
4.5.2	Longitudinal Sections (LS) of NERICA 1 rice roots infected by <i>Heterodera sacchari</i> and <i>Botryodiplodia theobromae</i> .	133

## LIST OF FIGURES

FIGURE		PAGE
3.1	Field layout of pathogenicity experiment at Ikenne, Ogun State	33
3.2	Microplot Layout in the field	39
4.1	Effect of <i>Heterodera sacchari</i> population densities on height of NERICA rice weeks after inoculation	47
4.2	Effects of <i>Heterodera sacchari</i> population densities on leaf production of NERICA rice weeks after inoculation	49
4.3	Effects of <i>Heterodera sacchari</i> population densities on leaf chlorophyll content of NERICA rice weeks after inoculation	50
4.4	Effect of <i>Heterodera sacchari</i> population densities on height of five NERICA rice cultivars at 11 weeks after planting	51
4.5	Effects of <i>Heterodera sacchari</i> population densities on leaf production of five NERICA rice cultivars at 11 weeks after inoculation	53
4.6	Effects of <i>Heterodera sacchari</i> population densities on leaf chlorophyll content of five NERICA rice cultivars at 11 weeks after inoculation	54
4.7	Effects of <i>Heterodera sacchari</i> population densities on number of tillers of five NERICA rice cultivars	55
4.8	Effects of <i>Heterodera sacchari</i> population densities on fresh shoot weight of five NERICA rice cultivars at 11 weeks after inoculation	57
4.9	Effects of <i>Heterodera sacchari</i> population densities on dry shoot weight of five NERICA rice cultivars at 11 weeks after inoculation	58
4.10	Effects of <i>Heterodera sacchari</i> population densities on fresh root weight of five NERICA rice cultivars at 11 weeks after inoculation	59
4.11	Effects of <i>Heterodera sacchari</i> population densities on dry root weight of five NERICA rice cultivars at 11 weeks after inoculation	61
4.12	Effects of <i>Heterodera sacchari</i> population densities on number of days to flowering of five NERICA rice cultivars at 11 weeks after inoculation	62

4.13	Effects of <i>Heterodera sacchari</i> population densities on total seed weight of five NERICA rice cultivars at 11 weeks after inoculation	64
4.14	Effects of <i>Heterodera sacchari</i> population densities on weight of 50 seeds of five NERICA rice cultivars	65
4.15	Effects of <i>Heterodera sacchari</i> population densities on root damage of five NERICA rice cultivars	66
4.16	Effect of <i>Heterodera sacchari</i> on height of NERICA rice cultivars weeks after planting	71
4.17	Effect of <i>Heterodera sacchari</i> on leaf production of NERICA rice cultivars weeks after planting	72
4.18	Effect of <i>Heterodera sacchari</i> on leaf chlorophyll content of NERICA rice cultivars weeks after planting	73
4.19	Effects of <i>Heterodera sacchari</i> on the height (cm) of five NERICA rice cultivars in the field at twelve weeks after planting	74
4.20	Effects of <i>Heterodera sacchari</i> on leaf production of five NERICA rice cultivars in the field at twelve weeks after planting	76
4.21	Effects of <i>Heterodera sacchari</i> on leaf chlorophyll content of five NERICA rice cultivars in the field at twelve weeks after planting	77
4.22	Effect of <i>Heterodera sacchari</i> population on number of tillers of five NERICA rice cultivars in the field at twelve weeks after planting	78
4.23	Effect of <i>Heterodera sacchari</i> population on shoot weight of five NERICA rice cultivars in the field at twelve weeks after planting	79
4.24	Effect of <i>Heterodera sacchari</i> population on dry shoot weight of five NERICA rice cultivars in the field at twelve weeks after planting	81
4.25	Effect of <i>Heterodera sacchari</i> population on fresh root weight of five NERICA rice cultivars in the field	82
4.26	Effect of <i>Heterodera sacchari</i> on dry root weight of five NERICA rice cultivars in the field	83



4.27	Effect of <i>Heterodera sacchari</i> on total seed weight of five NERICA rice cultivars in the field at twelve weeks after planting	84
4.28	Effect of <i>Heterodera sacchari</i> on total 100 seeds weight of five NERICA rice cultivars in the field	85
4.29	Effect of <i>Heterodera sacchari</i> on grain yield of five NERICA rice cultivars in the field	86
4.30	Effect of <i>Heterodera sacchari</i> on root damage of five NERICA rice cultivars in the field	88
4.31	Effects of interaction between <i>Heterodera sacchari</i> and <i>Botryodiplodia theobromae</i> on height of NERICA rice cultivars	91
4.32	Effects of interaction between <i>Heterodera sacchari</i> and <i>Botryodiplodia theobromae</i> on leaf production of some NERICA rice cultivars	92
4.33	Effect of interaction between <i>Heterodera sacchari</i> and <i>Botryodiplodia theobromae</i> on leaf chlorophyll content of NERICA rice cultivars	94
4.34	Effects of interaction between <i>Heterodera sacchari</i> and <i>Botryodiplodia theobromae</i> on height of two NERICA rice cultivars	98
4.35	Effects of interaction between <i>Heterodera sacchari</i> and <i>Botryodiplodia theobromae</i> on leaf production of two NERICA rice cultivars.	99
4.36	Effects of interaction between <i>Heterodera sacchari</i> and <i>Botryodiplodia theobromae</i> on leaf chlorophyll of two NERICA rice cultivars	101
4.37	Effects of interaction between <i>Heterodera sacchari</i> and <i>Botryodiplodia theobromae</i> on height of two NERICA rice cultivars	108
4.38	Effects of interaction between <i>Heterodera sacchari</i> and <i>Botryodiplodia theobromae</i> on leaf production of two NERICA rice cultivars	109
4.39	Effects of interaction between <i>Heterodera sacchari</i> and <i>Botryodiplodia theobromae</i> on leaf chlorophyll content of NERICA rice cultivars	110
4.40	Effects of interaction between <i>Heterodera sacchari</i> and <i>Botryodiplodia theobromae</i> on height of NERICA 1 and NERICA 2 rice cultivars	117

4.41	Effects of interaction between <i>Heterodera sacchari</i> and <i>Botryodiplodia theobromae</i> on leaf production of two NERICA rice cultivars	118
4.42	Effects of interaction between <i>Heterodera sacchari</i> and <i>Botryodiplodia theobromae</i> on leaf chlorophyll content of two NERICA rice cultivars	120



## CHAPTER ONE

### 1.0

### INTRODUCTION

#### 1.1

#### Origin, distribution and botanical description of rice

The genus *Oryza* belongs to the grass family Poaceae (formerly Gramineae). There are 25 species of *Oryza*, out of which only two species are cultivated, namely, *Oryza sativa* L and *O. glaberrima* Steud (Onwueme and Sinha, 1991). Asian rice is classified as *Oryza sativa* L and African rice as *Oryza glaberrima* Steud (Onwueme and Sinha, 1991). Rice cultivation originated as early as 10,000 B.C. in Asia. Evidence shows that rice was grown in Thailand as early as 4000 B.C. and later spread to China, Japan and Indonesia. By 400 B.C, rice was cultivated in the Middle East and Africa (Onwueme and Sinha, 1991). Rice is an annual grass with erect culms of 60-80 cm in height. It has a shallow root system which is mainly concentrated in the upper soil layer, to a depth of 20-25 cm (Moldenhauer and Slaton, 2003). The young roots are white, thick, short and relatively unbranched. They elongate with age and produce a dense surface mat (Moldenhauer and Slaton, 2003). The culms are erect, cylindrical and smooth with solid nodes and hollow internodes. The internodes vary in length from 10-20 cm; the buds in the axils of leaves at the lowest nodes grow out to produce tillers. Each node produces one leaf, and each leaf has a lamina and long sheath which completely encircles the internode. The lamina has a length of 30-50 cm. The lamina is usually hairy in *O. sativa* and glabrous in *O. glaberrima*. The inflorescence is loose with many-branched panicles, each branch of the panicle bears one or more spikelets; an average panicle bears 100-150 kernels. The rice grain is enclosed by the lemma and palea, which together are called husks or hulls (Moldenhauer and Slaton, 2003). Rice remains essentially a grain for human consumption and a staple food for about half of the world's population (WARDA, 2008a).

Global demand for rice is expected to expand at slightly less than 1 percent per year, down from 1.7 percent in the 1990's. As a result, in 2011 world production could reach 481 million tonnes from 394 million tonnes (milled basis) in 1997-99 (FAO, 2011). Between 2001 and 2008, world paddy rice production was 594 million tonnes of which Africa produced 17.0 million metric tonnes (milled rice) and Sub-Saharan Africa (SSA)

produced 12.0 million tonnes (WARDA, 2008a; FAO, 2011). Rice has become a commodity of strategic significance across Africa (WARDA, 2008a), driven by the changing food preferences in the urban and rural areas, compounded by high growth rates and rapid urbanization. Rice consumption in SSA increased by 4.52% per annum between 1961 and 2010 (FAO, 2011).

Rice is grown in nearly all parts of Nigeria under upland, lowland, deep-water and mangrove ecologies. At present, the bulk of Nigeria's rice is produced in the upland and lowland (rain-fed and irrigated) ecologies. However, the potential for rice production lies in the upland ecologies where the land resources are vast. Rice and maize are widely grown throughout the country, contributing between 12-15% of total food requirement in Nigeria (Onwueme and Sinha, 1991). About 30% of the 1.7 million hectares of rice in Nigeria are upland (WARDA, 2008b; FAO, 2011). The species of rice that are traditionally grown in Africa include *O. sativa* and *O. glaberrima*. Rice scientists have been aware of *O. glaberrima* for many decades (Brar and Khush, 1986). Among the eight species indigenous to Africa, *O. glaberrima* is known to have been selected and cultivated in parts of West Africa for more than 3,500 years (Bidaux, 1978). *Oryza glaberrima* has survived without the help or interference of man, the species has developed adaptive or protective mechanisms for resisting major biotic and abiotic stresses. Bidaux (1978) reported that *O. glaberrima* possesses a rich reservoir of useful genes for resistance to diseases and pests, as well as tolerance to acid soils, iron toxicity, drought, unfavourable temperatures and excess water. However, *O. sativa* is high yielding, most widespread but susceptible to biotic and abiotic stress in the environment (Bidaux, 1978; WARDA, 2008a). A major breakthrough was achieved in 1994 when fertile offspring of crosses between *O. glaberrima* and *O. sativa* were produced; this became NERICA (New Rice for Africa) rice. The NERICAs, an extended family of 3,000 siblings, are considered to be rice varieties that can resist or tolerate most of the regions stresses and can survive and produce high yields with minimal inputs (WARDA, 1999; WARDA, 2008b). Rice production is constrained by a number of macro and micro-organisms. These include insects, fungi, bacteria, viruses and phytonematodes which affect both the grain yield and grain quality (Babatola, 1984; WARDA, 2008a).

The nematode, *Heterodera sacchari* Luc and Merny, was originally described from sugarcane in West Africa (IRRI, 2000) and has since been found parasitizing rice in Nigeria and Benin (Babatola, 1984; Coyne *et al.*, 1996). International Rice Research Institute, Los Banos (IRRI, 2000) reported that a production loss due to *H. sacchari* infection on upland rice is high. Babatola (1983a) and IRRI (2000) observed that progressive population increase in the number of cysts per pot significantly reduced grain yield of upland rice. Afolami and Orisajo (2003) screened twenty improved varieties of upland rice including fourteen of the New Rice for Africa (NERICA) lines for their reaction to *Meloidogyne incognita* (Kofoid and White) Chitwood. Nine out of the 14 NERICA rice lines were found to be susceptible, five were observed to be tolerant to *M. incognita* and none was resistant to root-knot nematode. There is no information about the rot fungus (*Botryodiplodia theobromae*) and *H. sacchari* on rice. *Botryodiplodia theobromae* has been reported to cause yield losses in various crops and it exists in many agricultural lands in Nigeria. Therefore, it is relevant to study the interaction between *H. sacchari* and a soil-inhabiting rot fungus (*B. theobromae*) exhibiting a complex disease condition on growth and yield of rice. Meanwhile, no information is known about the relationship between *H. sacchari* and the rot fungus, *B. theobromae* on upland NERICA rice. The general objective of this research work was to ascertain the damage of *H. sacchari* and the effect of its interaction with *B. theobromae* on the growth and yield of NERICA rice cultivars, while the specific objectives were to:

- screen twenty five cultivars of rice for resistance to *Heterodera sacchari*
- determine the effects of *H. sacchari* on growth and yield of some NERICA rice cultivars.
- determine the relationship between *H. sacchari* and *B. theobromae* infection on growth and yield of NERICA rice.
- study the histopathology details of rice root infected with *H. sacchari* in order to understand the activities of the nematode in rice root
- study the histopathology of rice root infected with both *H. sacchari* and *B. theobromae*

## **CHAPTER TWO**

### **2.0 LITERATURE REVIEW**

#### **2.1 Rice production and consumption in Sub-Saharan Africa (SSA)**

In 2006, the total quantity of milled rice consumed in Sub-Saharan Africa (SSA) was 14.7 million tonnes (WARDA, 2008a). During 2005-2010, rice consumption in SSA grew at 5.84% per year. The increase in rice consumption is attributed to high demand in Southern and West Africa, where rice consumption increased to 11.58% and 6.55% per year, respectively (WARDA, 2008a; FAO, 2011). In 2006, West Africa produced 6.24 million tonnes of milled rice and had a yearly average of 5.06 million tonnes of rice produced over a period of 2005-2010 (WARDA, 2008a; FAO, 2011). Rice production in West Africa has doubled in the last 20 years from 2.76 million tonnes in 1985 to 5.75 million tonnes in 2005 (WARDA, 2008a). But with annual rice consumption increasing at 6.55%, well above production rate between 2005-2008, the short fall in local rice production in West Africa has increased significantly (WARDA, 2008a, FAO, 2011). As a result, main rice producing and consuming sub-region of the continent imports up to 42% of its consumption requirements via international market (WARDA, 2008a; FAO, 2011). The increase in rice production was mostly in Sierra-Leone followed by Senegal, Benin, Nigeria and Guinea Bissau. In Central Africa, milled rice production was 300,000 tonnes from 2005-2010 and was estimated at close to 321,000 tonnes in 2010 (FAO, 2011). Although, rice is not the region's main staple food, its production has increased by more than 90% since 1970 (FAO, 2000). Rice yield and area planted in Central Africa was 2.78% and 0.16%, respectively from 2005-2010 (FAO, 2011).

The average harvested area and yield were estimated at 466,000 hectares and 0.96 tonnes per hectare respectively (WARDA, 2008b; FAO, 2011). In East Africa, the average annual milled rice production was 2.6 million tonnes in the period of 2005-2010 (FAO, 2011). In 2006, the milled rice production estimated for East Africa was 3.1 million tonnes (WARDA, 2008b; FAO, 2011). The Southern Africa sub-region produced 118,270 tonnes of milled rice over the period of 2005- 2010 with an annual growth rate of 16.18% in that

region (FAO, 2011). Out of the total harvested rice area of 204,000 hectares in 2010, Mozambique accounted for 180,000 hectares (FAO, 2011). Asian countries produced about 90% of the 576 million tonnes of rice grown worldwide in 2008 (WARDA, 2008a, FAO, 2011). Typically, China and India together produce about 50% of the world's rice and it is a significant agricultural crop in more than 50 other countries (FAO, 2000 and 2011). About 96% of the rice grown world wide is consumed in the countries where it is produced with some exceptions. The United States of America, for example, exported about 37% of the 8.7 million tonnes it produced in 2010 and Pakistan exported about 28% of its 7.2 million tonnes (FAO, 2011). In the same year, Thailand exported 6.6 million tonnes or about 26% of its total rice production, while India exported 1.5 million tonnes or about 1.1% of total production. The major rice importing countries include Cote d' Ivoire, Nigeria, Philippines, Iran, Saudi Arabia, Brazil, Senegal, Japan and Indonesia (FAO, 2011).

## **2.2 Agronomic procedures in upland rice production**

In order to grow upland rice, a piece of fertile, well drained loamy soil with good water retention capacity in an ecological zone with at least 14-20 mm of five-day rainfall during the growing cycle is most appropriate. Land should be cleared and tree stumps removed before ploughing, ploughing is done once and harrowing, twice with the first rain. Harrowing is done two weeks after ploughing to allow the weeds to die and rot. Quality seeds with high percentage viability (greater than 80%) and without insect damage or contaminants such as weed seeds, stones e.t.c should be planted. A germination test should be conducted on seeds to establish rates to use based on seed viability (Onwueme and Sinha, 1991). The time of planting in savanna agroecology is between May and June while in the forest ecology, time of planting is between April and May (i.e when the rain is well established).

Method of planting include dibbling, whereby 5-8 seeds are planted at a depth of 2-3 cm while drilling method is a method of making a small groove 2-3 cm deep in the soil and seeds are planted sparsely in the groove and covered with soil and broadcasting method is the spreading of seeds on the soil surface without any specific pattern (Onwueme and Sinha, 1991). Rice can be planted at a spacing of 30 cm x 30 cm or 20 cm x 20 cm, seed rate of 50-60 kg/ha is appropriate for dibbling method. For drilling method, 25 cm x 30 cm



spacing is appropriate with 5 cm within row, and seed rate of 75-80 kg/ha (Onwueme and Sinha, 1991; Moldenhauer and Slaton, 2003). Two to three weeks after planting, seedlings are thinned down to 2- 4 per stand for dibble-seeded seedlings. This will give a final plant density of 22- 44 plants/m<sup>2</sup> at 30 cm by 30 cm and 50-100 plants/m<sup>2</sup> for 20 cm by 20 cm spacing (Onwueme and Sinha, 1991; Oikeh *et al.*, 2008). Fertilizers supply nutrients essential for growth, nutrition and health of the rice plant. Fertilizers can be applied in organic or inorganic (mineral) forms or both (Oikeh *et al.*, 2008). Organic fertilizer can be in the form of manure, compost or crop residues, while mineral fertilizers are manufactured. It is important to apply the right quantity and at the right time to obtain optimum yield and for environmental protection (Onwueme and Sinha, 1991; Moldenhauer and Slaton, 2003; Oikeh *et al.*, 2008).

Types of fertilizers include; Urea, Ammonium sulphate, Ammonium nitrate, Calcium nitrate, Muriate of potash e.t.c (Moldenhauer and Slaton, 2003; Oikeh *et al.*, 2008). On a rice field with nitrogen deficiency, 60-80 kg/ha urea is appropriate while on a phosphorus deficient field, 30-60 P<sub>3</sub> O<sub>5</sub> kg/ha is required and on potassium deficient field, 30 K<sub>2</sub>O kg/ha is recommended (Oikeh *et al.*, 2008). On a small scale, thorough hoe weeding should be done 2-3 weeks after emergence while second weeding is between 6-7 weeks after emergence before panicle initiation (Oikeh *et al.*, 2008). Pre-emergence herbicide such as Ronstar<sup>™</sup> at the rate of 4-6 l/ha is also effective 2-3 days after planting (Oikeh *et al.*, 2008). Ronstar<sup>™</sup> at the rate of 5-6 litres/ha can also be applied at 14-21 days after planting (Moldenhauer and Slaton, 2003; Oikeh *et al.*, 2008). Rice insects can be managed using bio-pesticides such as neem seed oil and neem powder at the rate of 22 litres of neem seed oil in 220 liters of water /ha or 800 kg/ha of neem powder in 220 liters of water is very effective against termites and other insects (WARDA, 2005; Oikeh *et al.*, 2008). Entomopathogenic fungus *Metarrhizium anisopliae* is an effective biological control agent used against termites on upland rice. Two grammes of commercial *Metarrhizium* powder mixed with 60 cm<sup>3</sup> of saw dust is very effective against termites and grasshoppers (WARDA, 2005; Oikeh *et al.*, 2008). Similarly, rice diseases such as fungi can be controlled by applying Quadris<sup>™</sup> 2.08 SC at the rate of 4 litres per ha. The planting of resistant, acceptable and high yielding rice cultivar is also recommended in controlling rice diseases such as sheath rot; stem rot and sheath blight (Moldenhauer and Slaton, 2003;

Cartwright and Lee, 2003). Oikeh *et al.* (2008) recommended that randomly erecting scarecrows in the field is very effective in the control of birds. At thirty to forty five days after flowering, matured plants are cut about 10-15 cm above ground using a sickle. Harvested rice are threshed using a mechanical thresher. Threshed rice are dried to a safe moisture content of 13-14% before storage (Moldenhauer and Slaton, 2003; Oikeh *et al.*, 2008).

### **2.3 Uses and nutritional composition of rice**

Rice is used for a variety of food and non-food products. Foods include cooked rice, breakfast cereals, desserts, rice flour and it is also used in the form of parched rice, rice flakes, puffed rice and rice pudding. Starch made from broken rice is used as laundry starch. Rice is also used in the manufacture of cosmetics and textiles. Beer, wine and spirits are also made from rice (Onwueme and Sinha, 1991). Rice wine which contains 10-15% alcohol is usually made from glutinous rice (Onwueme and Sinha, 1991). Rice bran has a high oil content of (14 -17%) and can be used as cooking oil, soap and insecticide carrier. The inedible rice hull is used as fuel and fertilizer. Straw from the leaves and stems is used as bedding for animals and for weaving roofs, hats, baskets and sandals (Onwueme and Sinha, 1991). According to the United Nations, Food and Agricultural Organization (FAO) rice supplies an average of 889 calories per day per person in China. In contrast, rice provides an average of 82 calories/day/person in the United States (FAO, 2000).

Rice is a nutritious food, providing about 90% of calories from carbohydrates and as much as 13% of calories from protein. The fibrous bran of brown rice is rich in oil, protein, thiamin, riboflavin and niacin and minerals such as iron, phosphorus and potassium (Onwueme and Sinha, 1991). The nutritional status and energy of rice per 100 g is as follows; 0.12 g of sugar, 1.3 g of dietary fiber, 0.66 g of Fat, 7.13 g of protein, 0.070 mg of thiamin (vitamin B1), 0.049 mg of riboflavin (vitamin B2), 1.6 mg of niacin (vitamin B3), 1.014 mg of pantothenic acid (vitamin B5), 0.164 mg of vitamin B6, 8 µg of folate (vitamin B9), 28 mg of calcium, 0.80 g of iron, 25 mg of magnesium, 115 mg of phosphorus, 115 mg of potassium, 1.09 mg of zinc, 1.088 mg of manganese and 1530 KJ of energy 370 kcal (USDA, 2008)

## 2.4 Nematodes as constraints to rice production

Large losses occur on the field and in storage, due to fungi, bacteria, birds, rodents, and nematodes. Plant-parasitic nematodes have been reported to exhibit diverse parasitic habits as a result of their activities during penetration, feeding, development, reproduction and establishment on plant root, as a result causing damage and malfunctioning of the physiological processes involved in plant development and consequently resulting in poor growth and yield loss (Bridge *et al.*, 2005). Rice nematodes can be conveniently divided into two groups depending on their parasitic habits; the foliar parasites (feeding on stems, leaves and panicles) and the root parasites (Bridge *et al.*, 2005).

*Meloidogyne incognita* a root parasite, caused poor seedling establishment and 60% yield reduction (Babatola, 1984). Significant damage and yield reduction are more severe in upland rice than irrigated rice where infested root tips usually become swollen and hooked due to *M. graminicola* (Fademi, 1984). Nematodes have been reported to predispose rice plants to secondary infection by bacteria or fungi which in turn lead to a complex disease interaction, where necrotic areas develop around nematodes as they migrate and feed on cortical tissues but diminish as nematodes penetrate deeper into the roots. This suggests a phoretic relationship between the rice root nematodes and soil micro-organisms, as necrosis does not occur at all in the absence of these soil-borne pathogenic micro organisms (Babatola and Bridge, 1980). Similarly 'root browning' of rice, caused mainly by soil micro-organisms such as *Fusarium* spp. and *Pythium aphanidermatum* increased in the presence of *Hirschmanniella oryzae* (Lee and Park, 1975). Jonathan and Velayuthan (1987) reported that inoculation of one or ten *H. oryzae* per gram soil caused 27% and 39.4% yield loss respectively. Babatola (1983a) reported that *Heterodera oryzicola*, *H. elachista* and *H. sacchari* were damaging to rice grown in the upland and flooded conditions. In India, yield losses between 17-42% are attributed to *H. oryzicola* (Kumari and Kuriyan, 1981). Babatola (1983a) considered *H. sacchari* to be potentially important on rice in Nigeria. Fawole and Raji (1988) reported that soils infested with *H. sacchari* may not be suitable for upland rice production.

## 2.5 Importance of nematodes in rice production

In Nigeria, twenty-five species of nematodes in eleven genera are associated with rice (Babatola, 1984). Those of economic importance to rice production include; *Aphelenchoides besseyi*, *Hirschmanniella spinicaudata*, *H. oryzae*, *H. imamuri*, *Meloidogyne incognita* and *Pratylenchus brachyurus*. *Aphelenchoides besseyi* is seed-borne, causing white-tip disease in most rice growing areas and leading to reduced vigour and malformation of rice plants. Infestation is usually greater in swamp rice than in upland rice. A grain yield loss up to 30% has been recorded in Nigeria (Babatola, 1984). An infested rice plant can host between 200 and 400 nematodes per 100 seeds. *Hirschmanniella* spp. is destructive on the rice plant. They invade the roots of the plant causing necrosis in the cortical tissues as the nematode migrates further into the root. Necrotic lesions in plant roots induced by plant-parasitic nematodes, consequently retards growth of rice, causes yellowing of plant, flowering delay, with eventual root rot (Babatola, 1983b). A grain yield loss of 31-34% at a population level of 1000 nematodes/ plant or 500 nematodes per 1dm<sup>3</sup> of soil has been recorded due to infestation of *H. spinicaudata*, *H. oryzae* and *H. imanuri* (Adesiyani *et al.*, 1990). The cyst nematode, *Heterodera sacchari* is pathogenic on rice plant causing retardation of root growth, with root turning brown or black. Infestation also leads to proliferation of secondary roots of the rice plant, which serves as a compensatory function (Ou, 1984). Similarly, Fawole and Raji (1988) reported that upland rice varieties infested with 50 cysts significantly reduced shoot and root dry weights and number of tillers of these rice varieties. Salawu (1992) reported that *H. sacchari* reproduced and multiplied on OS6 variety of rice and caused extensive damage to rice roots.

## 2.6 Damage and symptoms expression due to cyst nematode on rice

Four species of cyst nematodes have been identified as pests of rice; *Heterodera oryzicola*, *H. elachista*, *H. oryzae* and *H. sacchari*. *Heterodera oryzicola* is found only on upland rice in Kerala State, India (Bridge *et al.*, 2005) and *H. elachista* specifically on upland rice in Japan (Okada, 1955). *Heterodera oryzae* occurs on lowland rice in parts of Ivory Coast, Senegal (Fortuner and Merny, 1979) and in Bangladesh (Page and Bridge, 1978). *H. sacchari* occurs on upland and flooded rice throughout West Africa (Côte d'

Ivoire, Ghana, Guinea, Benin, Togo, Nigeria and Liberia) (Babatola, 1984; Lamberti *et al.*, 1991; Coyne *et al.*, 1996, 1999; Coyne and Plowright, 2000a).

The symptoms of infection of each species are similar, root growth is suppressed and infected twiggy roots turn brown or black. Lemon shaped white females and brown cysts can be observed protruding from infected roots (Bridge *et al.*, 2005). Rice responds to *H. sacchari* by the proliferation of secondary roots, which have compensatory function (Babatola, 1983b). Generally, the reduced size and function of cyst-nematode infected roots leads to leaf chlorosis and slowed plant growth and development, i.e. stunting and reduced tillering. Jayaprakash and Rao (1984) observed patches of seedling death in heavily infested fields by *H. oryzae* and *H. elachista* in upland rice. Similarly, Babatola (1983) reported *H. sacchari* to be damaging in upland rice and rice grown in flooded conditions. Reversat (1975) also reported that, second stage juveniles of *H. oryzae* are well adapted to flooded conditions where rice is cultivated.

## **2.7 The cyst nematode *Heterodera* species: Taxonomy, description, development and life cycle.**

Taxonomically, the cyst nematodes, *Heterodera* species Schmidt, 1871 belong to the family Heteroderidae in the superfamily Tylenchoidea of the Order Tylenchida. The family is characterized by marked sexual dimorphism (Hunt *et al.*, 2005). The males are vermiform with body often twisted through 180° on heat relaxation, while the females are obese and lemon-shaped, approximately 300µm in diameter with a distinct neck and are either partially enclosed in root tissue or in the soil. The cuticle is thick and whitish at first but changes to brownish black in color as cyst matures. Eggs are retained within protective cyst. In young females, excretory pore is visible at level of or posterior to median bulb valve plates. The second stage juveniles are vermiform between 450-600 µm long with stylet and labial region skeleton robust (Hunt *et al.*, 2005). Juveniles and eggs of *Heterodera* species are retained within protective cyst. The juveniles of *H. sacchari* in protective cysts hatch freely in water but there is evidence that exudates from actively growing roots are required to stimulate hatch from cysts of *H. oryzae* and *H. oryzae* (Jayaprakash and Rao, 1982). This difference in hatching behaviour indicates that second stage juveniles from previous generation egg sacs invade rice during crop growth and that cysts are principally a means of survival (Bridge *et al.*, 2005). In contrast, *H. sacchari*

rarely has an egg sac and eggs hatch freely in water. The life cycle of *Heterodera* spp is completed in 24-30 days at a temperature range of 28-32°C, which allows multiple generations depending on the number of days it takes the crop to mature. *Heterodera oryzicola* is said to have 12 generations/year in continuous rice cultivation while *H. oryzae*, *H. elachista* and *H. sacchari* have 2-3 generations per crop (Sharma and Swarup, 1985). *Heterodera oryzicola* is dependent on rice root diffusates to induce substantial egg hatch; this is not the case with *H. sacchari*, which will hatch freely in water (Ibrahim *et al.*, 1993).

## 2.8 Other nematodes associated with rice

Ten species of root lesion nematodes have been reported on rice throughout the world. The most common are *Pratylenchus zae* found in Africa, North, Central, and South America, Australia, South and South-East Asia and *P. brachyurus* was reported from Africa and Philippines (Bridge *et al.*, 2005). *Pratylenchus* spp cause discrete lesions in the root cortex which become necrotic and coalesce as infection spreads (Bridge *et al.*, 2005). *Hoplolaimus* spp. have been found on upland rice, *H. indicus*, a migratory endo-parasite was reported to be a damaging parasite of rice in India and Nepal (Sharma *et al.*, 2001). Another species *H. clarissimus* was found associated with damage on rice in Togo where rice is cropped continuously on the same fields (Coyne *et al.*, 1996). Damage due to *H. indicus* is not always obvious in the field and in the early seedling stage, is very similar to nitrogen deficiency. Leaves of seedlings infected by *H. indicus* are yellowish before turning brown and brittle with ash-colored tips. Plants are stunted with shortened upper internodes, new leaves can be curled (Bridge *et al.*, 2005). Rice roots have brown lesions at invasion points, cavities can be found in the cortex, cells lose their rigidity, vascular elements become distorted and roots become flaccid (Alam *et al.*, 1978). Ramana and Rao (1978) reported that 100-10,000 of *Hoplolaimus* sp. / plant can reduce numbers of tillers by 21.5-6.0% and grain yield by 10.7-19.8%. *Xiphinema bergeri* is very common in flooded rice fields of Senegal, Côte d' Ivoire, Guinea, Ghana and Gambia (Fortuner and Merny, 1973; Coyne *et al.*, 1999; Coyne and Plowright, 2000) and appears to be widespread in Western Africa. *Xiphinema rotundatum* has been found occasionally in Côte d' Ivoire (Merny, 1970). Several species of *Xiphinema* have been recorded from the rhizosphere of upland rice, *X. oryzae* and *X. nigeriense* in Nigeria; *X. seredouense* in Guinea; and *X. cavenessi* in Côte d' Ivoire (Bridge *et al.*, 2005). A total of 23 species of *Xiphinema* have been found in

large populations associated with chlorosis and stunting of rice in West Africa (Coyne *et al.*, 2000). *Aorolaimus nigeriensis* has been found in large populations associated with chlorosis and stunting of rice in Togo (Coyne *et al.*, 1996). *Scutellonema brachyurus* and *S. clathricaudatum* are considered to be possible damaging parasites (Baqri and Ahmad, 2000; Coyne *et al.*, 2001).

Four species of *Meloidogyne* occur on upland and hydromorphic rice: *M. incognita* (Costa Rica, Cuba, Egypt, Côte d' Ivoire, Nigeria, South Africa and Japan), *M. javanica* (Brazil, Egypt, Comoro Islands, Nigeria, Côte d' Ivoire and Ghana) (Coyne *et al.*, 1999), *M. arenaria* (Nigeria, Egypt and South Africa) and *M. salasi* (Costa Rica and Panama) (Lopez, 1984). All *Meloidogyne* spp. can cause swellings and galls throughout the root system. Infected root tips become swollen and hooked, a symptom which is especially characteristic of *M. graminicola* and *M. oryzae* (Sancho *et al.*, 1987). *M. incognita* can cause poor seedling establishment and reduced yields in upland rice. Yields can decrease to 60% when 8000 eggs and juveniles/dm<sup>3</sup> of soil are present at sowing (Babatola, 1984). Significant yield reductions can occur in both upland and irrigated rice with *M. incognita* (Ibrahim *et al.*, 1972), but damage is generally more severe under upland conditions (Fademi, 1984). Bridge *et al.* (2005) reported that high initial populations (above 1000 eggs/plant of *M. incognita* and *M. javanica*) are necessary to cause grain yield reduction in rice, and populations as high as 35,000 eggs/plant will reduce growth by 40% (Ferraz, 1995). *M. graminicola* can cause economic yield loss in upland, lowland and deepwater rice. In upland rice, there is an estimated reduction of 2.6% in grain yield for every 1000 nematodes present around young seedlings (Rao and Biswas, 1973). The population levels which cause 10% loss in yield of upland rice are 120, 250 and 600 eggs per plant at 10, 30 and 60 days age of plants respectively (Rao *et al.*, 1986). Bridge and Page (1982) reported that 4000 juveniles per plant of *M. graminicola* can cause destruction of up to 72% of deepwater rice plants.

## **2.9 Host-parasite relationships of plant-parasitic nematodes on crops**

Consequent upon feeding by root-knot nematode second stage juveniles after penetration, susceptible host plants respond by undergoing pronounced morphological and physiological changes. The most important of these is the development of elaborate feeding sites called giant cells (Bird, 1962). Further nematode development cannot take

place without this unique response. Giant cell formation is therefore very essential for a successful host/parasite relationship in root-knot nematodes (Hussey, 1985). Giant cells are highly specialized cellular adaptations induced and maintained in susceptible host plants by the feeding nematode. Cytological investigations make it clear that giant cells are formed by repeated endomitoses without subsequent cytokinesis (Huang and Maggenti, 1969; Jones and Dropkin, 1975). Giant cells are transfer cells passing nutrients to the nematode (Huang, 1985). Tissues preferred for giant cell formation are the primary phloem and adjacent parenchyma (Hussey, 1985). However Fawole (1988) observed that giant cells were always closely associated with xylem tissues in yam. Furthermore, Fawole (1988) observed strikingly thin-walled giant cells in white yams compared with those formed in tomato roots, although they have dense cytoplasm and are as multinucleate as those observed in tomato. Giant cells formed in yam tubers also contained smaller and fewer nuclei when compared to those in tomato roots.

Thorne (1961) reported that the position of the female root-knot nematodes in potato tubers is usually indicated by brown spots formed by cells that are in contact with the egg mass. He also reported that the gelatinous matrix of the egg mass is toxic to cells and causes them to turn brown but does not cause decay. Nwauzor (1982) also reported the presence of brownish dark spots in the cortical areas of the yam tubers infected with root-knot nematodes. He concluded that the spots corresponded to the location. Fawole (1988) also observed a necrotic ring around the female root-knot nematode in yam tissue after the production of gelatinous matrix. The necrotic reaction did not affect the normal nematode growth and development as second stage juveniles were seen in cells adjacent to the necrotic ring indicating that second stage juveniles were able to hatch and cause further attack in the tuber (Fawole, 1988). Thorne (1961) concluded that a similar toxicity may occur in sweet potato and the affected sweet potato cells may not adequately perform the functions of storing starch. Nwauzor (1982) reported that adult female nematodes occupy large space in the infected yam. Yam cells that should have been engorged with starch are disrupted, compressed and displaced by enlarging adult root knot nematode. As a result there is less food content in the infected tuber.

In their studies, Adesiyan *et al.* (1975) reported that the yam nematode, *Scutellonema bradyi* caused an extensive disintegration of the yam epidermis. They



observed that the nematodes activities were limited to the tissue lying within the periderm layer and those immediately beneath the periderm. Nematode activities, according to them, disrupted the yam tissue by emptying the cell contents and breaking of cell walls. Cavities which may serve as infection sites for other invading micro-organisms were also observed in both the epidermis and cortex.

The extent of vascular damage by *Heterodera* has been reviewed (Endo, 1971). The mechanism of penetration and establishment of *Heterodera* spp. in their host was studied and reported by Endo (1975). Second stage larvae of *H. glycines* can enter the root of soybeans by direct penetration of cells and traverse the cortex toward the vascular region. If the penetration is not direct, the perpendicular orientation is lost. Instead, the larval body is often found parallel to the root axis within the cortex during nematode migration. When the nematode becomes sedentary and begins to feed intensively, the anterior portion of the nematode is usually directed toward the vascular elements. The second stage juvenile may have its lip region in a cortical or endodermal cell from which it can stimulate a syncytium (Endo, 1975). The multinucleate state can develop 24 hours after inoculation when cells that lie adjacent to the initially stimulated cell merge with this cell. Endo (1975) also indicated that the continuity of cytoplasm and the ease of movement of nuclei from cell to cell were facilitated by openings in adjacent cell walls. Physical stress and chemical action appeared to be major factors in cell wall dissolution since cellular hypertrophy was evident during early stages of syncytia development. Syncytia associated with females were extensive and were usually initiated near the protoxylem poles, where the vascular tissues were readily incorporated. Syncytia encompassed tiers of cells to either side of the nematode laterally and numerous cells longitudinally. Large sectors of developing roots were transformed into syncytia upon which the nematode fed. In an ultrastructural study of soybean cyst nematode in the susceptible cultivar 'Lee', Gipson *et al.* (1971) observed that cell walls were perforated in syncytia within 42 hours after inoculation. The edges of the perforations indicated enzymic breakdown of the walls. The dense cytoplasm in syncytia, indicated in light microscope studies, was identified ultra-structurally as plastids and large amounts of endoplasmic reticulum-like materials. Endo (1970) reported nucleic acids at the infection sites penetrated by larvae of *H. glycines* on susceptible 'Lee' soybeans. He observed an increase in nuclear size and deoxyribose nucleic acids (DNA) synthesis. Endo

and Veech (1970) similarly showed an increase in enzyme levels as syncytia developed in susceptible 'Lee' variety of soybeans infected by *H. glycines*.

Salawu (1986) revealed that sections of sugarcane roots harvested at 10 days after inoculation showed the presence of *H. sacchari* in the cortex and some cortical cells surrounding the nematode head region were necrotic. Similarly, root sections of infected sugarcane at 15 days after inoculation showed well formed large cells induced by *H. sacchari*, there were 2-4 large cells around the nematode head and each large cell contained dense cytoplasm and large nucleus. All the large cells formed were of parenchymatous phloem cell origin (Salawu, 1986). In addition, Salawu (1986) observed that transverse sections of infected sugar cane roots showed that pericycle and phloem tissues were extensively damaged by the nematode.

Fademi and Fawole (1992) reported that *M. incognita* induced the development of many oval-shaped giant cells in a susceptible rice cultivar within 14 days. It has been reported that one nematode feeds on 5 - 6 giant cells (Hussey, 1985) but Fawole (1988) observed between 1-3 giant cells surrounding a nematode head in white yam tuber infected by *M. incognita*. However, one giant cell per nematode was most common. The thickness of giant cell walls appears to vary from one host crop to another. There is very little information about the histopathological changes induced by *Heterodera sacchari* on rice roots.

## **2.10 Fungal pathogens associated with rice**

Most rice diseases are caused by fungi, attacking the plant foliage, stem, roots, leaf sheath, inflorescence and grains (Scardaci *et al.*, 2003). Some fungal diseases of economic importance include: Rice blast disease caused by *Magnaporthe grisea*. It is found in both upland and lowland environments. The fungus infects young seedlings, leaves, panicles and other aerial parts of the adult plant (Scardaci *et al.*, 2003). It is also known as leaf blast, node blast, panicle blast or neck rot (Scardaci *et al.*, 2003). Leaf spots are spindle-shaped with brown or reddish- brown margins, ashy centers and pointed ends (Scardaci *et al.*, 2003). When nodes are infected, they become black and rotted, while infection of panicle base causes the panicle to fall off. In severe infections, secondary branches and grains are also affected (Scardaci *et al.*, 2003). In Philippines, the disease accounted for 50% yield loss, while in Japan, it accounted for 24.8% of total yield loss (Scardaci *et al.*, 2003).

Seedling blight and seed decay is caused by *Bipolaris oryzae*, *Pythium* sp., *Rhizoctonia solani*, *Achlya* sp. and *Sclerotium rolfsii*. Seedling diseases cause spotty irregular stands on the field as a result of seed decay (Krausz, 1994). Seedling disease complex results from activity of various kinds of fungi, most of which grow on the kernels or hulls of rice seed or on soil organic matter (Krausz, 1994). Fungi will gain access into the germinating rice seedling and either injure or kill them, if infected seedlings emerge from the soil; they often die back (Krausz, 1994). Those that manage to survive are weak and chlorotic in appearance. Damage is most severe on early seeded rice and deeply planted rice (Scardaci *et al.*, 2003).

Sheath blight caused by the fungus *Rhizoctonia solani* is perhaps the most important disease of rice in Arkansas and southern United States, it was first reported in Japan in 1910, has also been reported in many major rice growing areas of the world. This disease has been reported in Nigeria on rice variety OS6 (Krausz, 1994).

Stem rot caused by *Sclerotium oryzae* becomes noticeable on the rice fields during the latter stages of maturity. The disease occurs in the fields and causes premature death and lodging of rice plants which makes harvesting difficult (Krausz, 1994). Stem rot was first reported in Italy in 1876 and has long been known in many other areas such as Europe, Asia, America and several African countries where rice is grown (Krausz, 1994). Stem rot is a serious rice disease; yield losses in epidemic years of up to 80% have been reported. In a survey conducted in the Philippines, 67% of the tillers examined were infected with stem rot organisms (Krausz, 1994).

Kernel smut caused by the fungus *Neovossia barclayana*: This disease causes losses in both yield and quality of grain. The endosperm of the grain is attacked by the fungus causing either part or all of the starchy material to be replaced by a black mass of smut spores (Krausz, 1994). This disease has been reported to cause a significant reduction in yield and quality of rice in U. S. A, West Africa and Asia (Krausz, 1994).

Black sheath rot caused by *Gaeumannomyces graminis* var. *graminis*: Black sheath or crown rot was first considered as a minor disease of rice in Texas for several years (Krausz, 1994). Recently, it has become increasingly important in many rice growing areas of the world (Krausz, 1994). The fungus attacks the crown, lower leaf sheaths, and roots of the rice plant causing a dark brown to black discolouration of the leaf sheath from the

crown (Krausz, 1994). The disease is usually observed late in the main cropping season and may cause reduced tillering, poor grain fill and lodging.

## **2.11 Taxonomy and importance of *Botryodiplodia theobromae***

Taxonomically, *Botryodiplodia theobromae* Pat. belongs to the kingdom Fungi, Phylum Ascomycota, Family Botryosphaeriaceae (Kunz, 2007). *Botryodiplodia theobromae* Pat. grows and sporulates at 10-40°C although optimum temperature for its development is 25-30°C (Alam *et al.*, 2001). The highest mycelial growth was 78-90 mm and sporulation is 27-38 conidia/ 0.01ml was observed on potato dextrose agar (Alam *et al.*, 2001). The characteristic feature of ascomycetes is that they sexually produce spores, and the ascospores are contained within a sac (ascus). In most ascomycetes, the ascus contains eight ascospores and is turgid, ejecting its spores by a squirt mechanism. The explosive release of ascospores follows increased turgor pressure, caused by water uptake by the ascus. The fruiting body of an ascus when totally enclosed (in which the ascocarp has no special opening) is termed cleistothecia (Webster and Weber, 2007). *Botryodiplodia theobromae* is a well known parasite causing both field and storage disease of different crops, fruits and plantation trees (Alam *et al.*, 2001). It is an important pathogen of mango, cocoa and other tropical fruits (Alam *et al.*, 2001) and causes black-band disease of jute, crown rot diseases of banana fruit, fruit rot of coconut, stem-end rot of mango fruit, soft rot of pawpaw and guava and die-back in lemon plants (Alam *et al.*, 2001). According to Onyeka (2002), *B. theobromae* is predominantly responsible for cassava root rot disease in the humid forest and transition agroecological zones of Nigeria. Rot pathogens such as *B. theobromae* are wide spread in heavy poorly drained soils with high organic matter content (Onyeka, 2002). The pathogens cause root decay whereby the entire plant becomes wilted, defoliates and eventually dies (Onyeka, 2002). *Botryodiplodia theobromae* has been reported in both Africa and tropical America with estimated yield loss of up to 80% in cassava (Onyeka, 2002). Rot caused by *B. theobromae* affects plants at all growth stages causing serious deterioration of the roots. Affected roots are discoloured and decompose rapidly (Onyeka, 2002). In Nigeria, *B. theobromae* was found to be highly virulent on cassava in cassava growing areas (Onyeka 2002). This showed the relative importance of *B. theobromae* in disease etiology when compared with other rot fungi such as *Trichoderma* sp., *Fusarium solani*, *F. oxysporum* and *Apergillus niger* on cassava. Furthermore, Onyeka

(2002) also reported that *B. theobromae* is a non-specific pathogen with a wide host spectrum and had been previously reported on cassava mini-stems in Nigeria (Osai and Ikotun, 1993). Akinyele and Ikotun (1989) observed soft rot on cassava with characteristic foul odour and dark-blue discolouration of the rotted root tissue caused by *B. theobromae* on International Institute of Tropical Agriculture (IITA), Ibadan experimental field. Similarly, Boher *et al.* (1997) observed that *B. theobromae* was responsible for large scale damage on roots and stems of cassava in the Danyi plateau zone of South-west Togo. Oyetunji (2009) observed severe rot on rice root in a pot trial when rice cultivars, LAC 23, OS6 and NERICA 1 were inoculated with *B. theobromae* alone. Rice roots were reduced by 28.6%, 50% and 65%, respectively. When rice cultivars were inoculated with *B. theobromae* and termite simultaneously, roots were reduced by 42.7%, 62.2% and 81.3%, respectively.

## **2.12 Importance of nematode-fungi interactions**

All interactions of plant- parasitic nematodes with other plant pathogens have three components: the nematode, host and other pathogens. The plant pathogens known to interact with nematodes are mainly viruses, bacteria and fungi (Khan, 1993). *Anguina tritici* has been known to vector spores of *Dilophospora alopecari* which attacks aerial parts of cereals (Khan, 1993). The nematode, while moving between the leaf sheaths to reach the growing point, carries the fungal conidia and deposits them at the growing point (Khan, 1993). Khan (1993) also reported that the feeding process of all plant-parasitic nematodes produces wound in the host plant, either by simple micropuncture or by rupturing or separating cells. Furthermore, second-stage juveniles of sedentary endoparasites migrate intercellularly through the cortex and establishing within the vascular tissue to induce syncytia or giant cells through which secondary infection can be initiated by other pathogens. Syncytium, according to Holtmann *et al.* (2000) is the formation of a mass of cytoplasm containing several nuclei enclosed within a plasma membrane. *Pratylenchus penetrans*, a migratory endoparasite, has been implicated in synergistic interactions with *Verticillium dahliae*, showing distinct lesions on egg plant roots (Francl and Wheeler, 1993). Similarly, some species of root-rot fungi such as *Pythium*, *Rhizoctonia*, *Phytophthora*, *Sclerotium* and *Collectotrichum* are known to interact with plant-parasitic nematodes, the role of nematode in root-rot diseases is to assist the fungal pathogen in its

pathogenesis and increasing host susceptibility (Evans and Haydock, 1993). The lesions caused by lesion or burrowing nematodes or invasion tracks formed by penetrating juveniles of root-knot or cyst nematodes provides a better substratum for establishment and colonization by the fungal pathogens (Khan, 1993). Nordmeyer and Sikora (1983) demonstrated that inoculation of *Heterodera daverti* and *Fusarium avenaceum* on *Trifolium subterraneum* cv. Clare, increased the disease index significantly when the nematode was inoculated one or two weeks after the fungus. Also, there were more dead plants in the same treatments. Furthermore, cyst production was increased when *H. daverti* was inoculated one week after *F. oxysporum* on Clare. Saeedizadeh *et al.* (2003) observed that the presence of *M. javanica* prior to fungus caused reduction in the roots by 50-80%, and the presence of fungus prior to the nematode caused reduction in number of galls produced by the nematode. Also severe damage was observed above ground when pathogens were inoculated simultaneously on olive seedlings. Moorman *et al.* (1980) reported that *Meloidogyne* spp. increased wilt severity on tobacco when inoculated on the same portion of the root system with *F. oxysporum* f. sp. *nicotianae*. Starr and Martyn (1991) observed that cotton cultivars reported to be highly resistant to Fusarium wilt disease had greater incidence of vascular browning and plant mortality in the presence of *M. incognita* than when the nematodes were absent. In chickpea (*Cicer arietinum*) with high level of resistance to Fusarium wilt, co-infection by *M. artiellia* overcame the plant's resistance to wilt (Castillo *et al.*, 2003). Moderate to high population densities of *M. incognita* increased both the incidence and severity of cotton seedling disease caused by *Phytophthora parasitica* (Powell and Nusbaum, 1960; Fichtner *et al.*, 2005). In a study on tobacco, Powell *et al.* (1971) demonstrated that species of *Trichoderma* and *Penicillium* that were not recognized as pathogens caused substantial root rot disease when the plants were infected by *M. incognita*. Findings revealed that there was an increase in free amino acid in the giant cells of *M. incognita* infected tomatoes, which is a suitable substrate for *Fusarium oxysporum* growth (Sidhu and Webster 1977). The amount of root rot caused by *Pythium aphanidermatum* and *Rhizoctonia solani* on Chrysanthemum was further increased in the presence of *Pratylenchus coffeae* (Evans and Haydock, 1993). Similarly, *Pratylenchus penetrans* increased the infection levels of *Colletotrichum coccodes* and *R. solani* on Russet Burbank potato roots (Evans and Haydock, 1993).

## CHAPTER THREE

### 3.0 MATERIALS AND METHODS

#### 3.1 Soil sterilization

Sandy-loam topsoil collected from the International Institute of Tropical Agriculture (IITA), Ibadan (Lat. 7° 3'N, 3° 45'E at 232.5 m above sea level) was sterilized for two hours thirty minutes at 90°C using the soil sterilizer at the Nematology Laboratory, International Institute of Tropical Agriculture (IITA), Ibadan. The soil was allowed to cool for 24 hours and later transferred into 5-liter plastic pots and kept in the screenhouse until needed.

#### 3.2 Extraction of cyst nematodes from soil

Cysts of *Heterodera sacchari* (Plate 3.1) were extracted from field soil by the method described by Coyne *et al.* (2007) as follows: Two hundred centimeter cube (200 cm<sup>3</sup>) of air-dried soil sample collected from infested rice field at Africa Rice Center (ARC) Station, Ikenne, Ogun State (Long. 6° 32'E and 4° 40'E, Lat. 2° 67'N and 7° 97'N at 60.8 m above sea level) were turned into a bucket filled with 1000 ml of water and properly mixed together using a glass rod. Soil particles were allowed to settle for 60 seconds and the supernatant was slowly poured through a stack of nested sieves 2 mm to trap debris, 250 µm and 150 µm aperture sizes to trap cysts. The cysts that were trapped in the sieves were washed into a glass beaker. This process was repeated until there were no more cysts remaining in the bucket (Coyne *et al.*, 2007). One ml aliquots of cysts were taken from the nematode suspension with an Eppendorf pipette and thereafter, dispensed into a counting slide for cyst population estimation with the aid of a dissecting microscope.

#### 3.3 Extraction of eggs from *Heterodera sacchari* cysts

The cysts extracted from soil were placed in a glass Petri dish containing 10 ml of distilled water and, while observing with the aid of a dissecting microscope, cysts were individually pierced and crushed using a dissection needle in order to liberate the eggs and second-stage juveniles (J<sub>2</sub>). Broken cysts were washed into a measuring cylinder and the suspension agitated with a magnetic stirrer for five minutes to free eggs and juveniles.



Mag: x 250

**Plate 3.1: Brown cysts and white females of *Heterodera sacchari* extracted from the soil of an infested rice field at Ikenne, Ogun state.**



The liberated eggs and second-stage juveniles (J<sub>2</sub>) were gathered in a 1 L beaker. Subsequently, eggs and J<sub>2</sub> were collected on nested sieves of 90 µm, 38 µm and 25 µm aperture sizes; where aperture size 90 µm trapped the cyst cuticle, 38 µm and 25 µm trapped the emerging juveniles and eggs, respectively (Coyne, 1999). Extracted eggs and J<sub>2</sub> were multiplied on susceptible rice for all experiments as described in Section 3.4

### **3.4 Establishment and multiplication of *Heterodera sacchari* on OS6 rice cultivar**

Ten seeds of a susceptible rice variety OS6 (Salawu, 1992) were planted in 10-litre plastic pots containing steam-sterilized soil. Two weeks after planting, inoculation was carried out by making holes around the rice roots using a glass rod. Suspension containing 10,000 eggs and J<sub>2</sub> of *H. sacchari* were dispensed into the holes around the rice seedlings and then covered with soil. This was carried out in order to multiply nematode inoculum for the proposed experiments. Plate 3.2 is showing the white females of *H. saachari* multiplied on infested OS6 root.

### **3.5 Preparation of inoculum for the experiments**

Ninety days after nematode inoculation and subsequent multiplication on OS6 rice, the pots were carefully upturned and adhering soil particles were gently removed from the rice roots. Thereafter, cysts and white females were dislodged from roots using a strong jet of water into a 10 litre plastic bucket. Cysts were also extracted from soil as previously described in Section 3.2 (Salawu, 1992; Coyne, 1999). Cysts were recovered by decanting through nested 2000 µm which trapped soil particles and plant debris and 250 µm sieve which trapped the cysts. Cysts were rinsed from the 250 µm sieve into a filter paper held in a funnel and air-dried. Cysts were removed from samples with the aid of dampened camel hair brush under a Leica Wild M3C stereomicroscope. Subsequently, collected cysts were crushed as previously described in Section 3.3 in order to obtain eggs and J<sub>2</sub> (inoculum) required for the various experiments. Librated eggs and J<sub>2</sub> were put together in a 500 ml beaker containing distilled water for nematode population estimation.

### **3.6 Estimation of *Heterodera sacchari* inoculum**

The eggs and second-stage (J<sub>2</sub>) suspension were homogenized for four minutes using a magnetic stirrer.

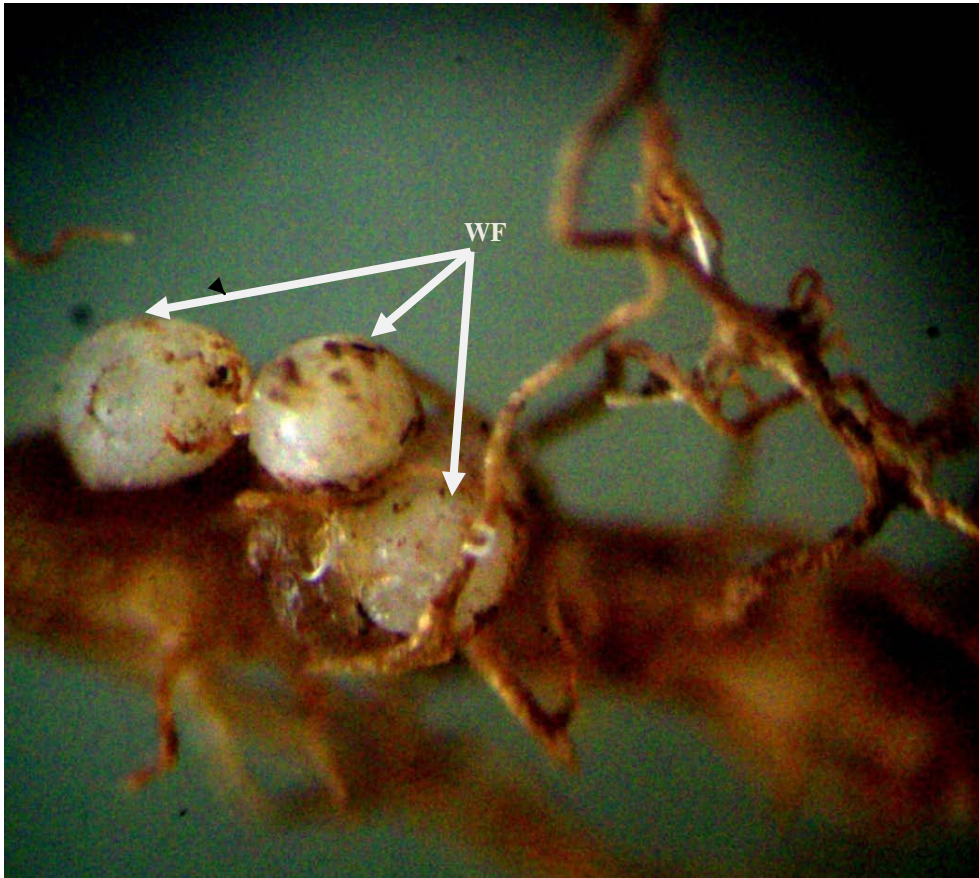

Mag: x 250

**Plate 3.2: White females (WF) of *Heterodera sacchari* on susceptible OS6 rice root.**

One millilitre of the homogenized *H. sacchari* suspension was taken during the process of stirring the suspension with the aid of a glass pipette into a counting slide. Egg and juvenile populations were counted using a compound microscope model (Wild Leitz GMBH). Counting was done three times and the average numbers of eggs and  $J_2$  / ml were estimated using the formula;  $\bar{Y} = y_1 + y_2 + y_3 / \text{number of counts}$ , where  $\bar{Y}$  is the average number of nematode count/ml,  $y_1$  is the number of first nematode count / ml,  $y_2$  is the number of second nematode count / ml and  $y_3$  is the number of third nematode count / ml, respectively. This was done in order to estimate the quantity of inoculum that would contain 5000 *H. sacchari* required for inoculation for the rice screening and pathogenicity experiments.

### **3.7 Preparation of culture media**

Thirty nine grams (39g) of Potato Dextrose Agar (PDA) was measured into a 1 litre conical flask and 200 ml of distilled water was added into the conical flask in order to dissolve the PDA, after which 800 ml of distilled water was added into the conical flask to make up the PDA solution to 1 litre. The media was autoclaved for 15 minutes at a temperature of 12 °C. The prepared agar was allowed to cool to a temperature of about 40°C and poured into sterile Petri dishes and stored in the refrigerator at the temperature of 4°C until when they were required.

### **3.8 Collection and surface-sterilization of infected rice root**

Infected rice roots showing rot symptoms were collected from Africa Rice Center (ARC) experimental field at Ikenne, Ogun State. The collected rice roots were rinsed in distilled water to remove adhering soil, after which the roots were placed on sterile paper towels to remove excess water. Rice roots were cut into 1-2 cm pieces before surface sterilization was done by passing the infected roots in three changes of 0.1% sodium hypochlorite for ten seconds each and the rinsing in sterile distilled water.

### **3.9 Isolation of *Botryodiplodia theobromae***

This activity was carried out in a sterile condition under the lamina flow hood which was surface-sterilized with 75% alcohol to reduce contamination. Two pieces of infected rice root were placed in the prepared PDA in Petri dishes. Thereafter, the Petri

dishes were placed in an incubator set at 28.1<sup>0</sup>C. After 48 hours, the different fungi in the Petri dish were sub-cultured into newly prepared PDA culture media and placed in the incubator for another 48 hours. The isolated subcultures were taken to Pathology Laboratory, IITA, Ibadan for identification with the aid of a compound microscope and fungi identification key. The pure cultures of the isolated *B.theobromae* were then preserved in a refrigerator set at 4<sup>0</sup>C until they were required for future experiments. Plate 3.3 shows the pure culture of *B. theobromae* isolated from rice root infected with *H. sacchari* collected from Ikenne, Ogun State, Nigeria.

### **3.10 Estimation of *Botryodiplodia theobromae* spores**

Ten milliliters (10 ml) of sterile distilled water was added to 2-week old *B. theobromae* mycelia on agar in the Petri-dish and washed into a 500ml sterile beaker. The suspension was thoroughly mixed and an Eppendorf pipette was used to measure out 0.2ml which was placed into a haemocytometer slide for counting. This was done five times and the average count per milliliter was determined at the Pathology Laboratory, IITA, Ibadan.

### **3.11 Extraction of *Heterodera sacchari* second-stage juveniles (J<sub>2</sub>) from infected root and infested soil using modified Baermann extraction technique**

This method was described by Hooper (1986). The set-up consists of a plastic sieve separated by a double-ply facial tissue placed on a collection tray. Rice roots were rinsed with tap water to remove soil particles and then cut into 1-2 cm pieces and thoroughly mixed. The chopped roots were placed and spread gently on the surface of facial tissue in the sieve. Thereafter, 200 ml of water was added into the collection tray. The whole extraction set up was left for 48 hours. Nematode extract from each tray was concentrated in a 100 ml beaker. Thereafter, the extract was homogenized for four minutes with a magnetic stirrer. The J<sub>2</sub> population in each extract was estimated by counting 1 ml aliquots under the dissecting microscope.

Soil from each pot was thoroughly mixed together, and then 250 ml of the soil was measured using a beaker. The soil was gently placed and spread on the surface of facial tissue in the sieve. Thereafter, 200ml of water was added into the collecting tray. The extraction process was done as previously described in this Section.

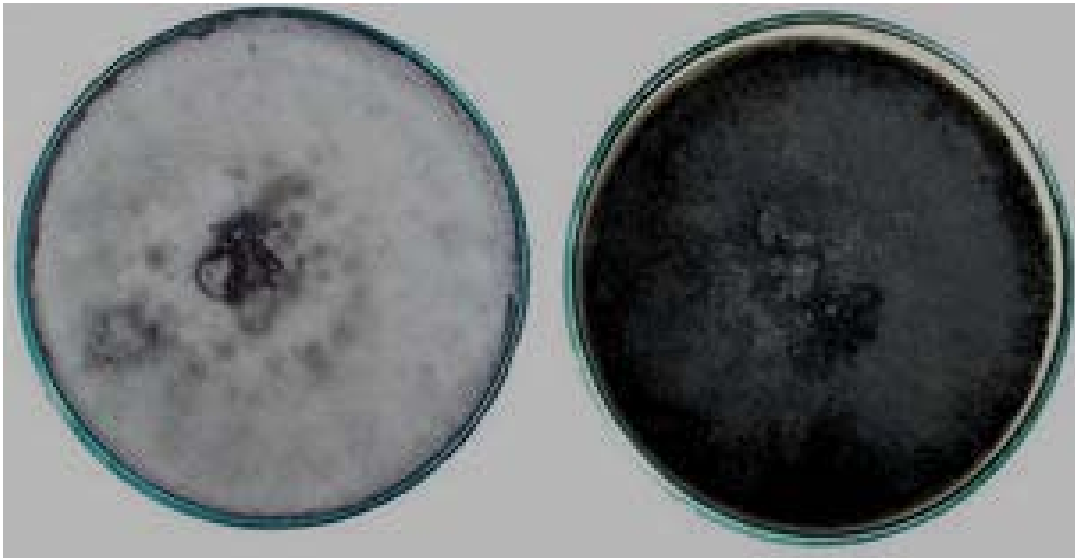

**Plate 3.3: Petri-dishes with *Botryodiplodia theobromae* after seven days (left) and after four weeks (right)**

### 3.12 Data analyses

Data was processed using Microsoft Excel (2003), count data were transformed using  $\text{Log}_{10}(X+1)$  before analysis (Gomez and Gomez, 1984). Data were transformed in order to follow normal distribution. Data were analysed with Analysis of Variance (ANOVA) using SAS 9.1 (2002) statistical analysis system package and means were separated using Least Significant Difference (LSD) at 5 % level of probability

### 3.13 Experiment 1: Screening of Twenty-four Rice cultivars for resistance to *Heterodera sacchari*

A trial was carried out in the screenhouse at the International Institute of Tropical Agriculture (IITA), Ibadan. Twenty four (24) cultivars of upland rice seeds were selected on the basis of wide cultivation across Nigeria. The seeds were obtained from Africa Rice Center (ARC) formerly known as West African Rice Development Association (WARDA), Ibadan. These included seventeen cultivars of upland New Rice for Africa (NERICA) 1, 2, 3, 4, 5, 6, 7, 8, 9, 10, 11, 12, 14, 15, 16, 17, 18 as well as LAC 23, Moroberekan, ITA 150, Suakoko, WAB 56-104, WAB 56-50. OS6 susceptible to *Heterodera sacchari* (Salawu, 1992), and CG 14, resistant (Plowright *et al.*, 1999) were also included as controls. Five litre (5 l) plastic pots filled with steam-sterilised soil were used for the experiment. Two seeds of each rice cultivar were planted per pot. Two weeks after planting, rice plants were thinned to one stand per pot. The next day, 100 ml of nutrient solution containing 1.8 g of Ammonium phosphate + 6.1 g of Potassium nitrate + 2.8 g of Calcium nitrate + 3.8 g of Magnesium sulphate/litre of water (Coyne, pers. com.) was applied to rice plants in each pot when plants were showing symptoms of nutrient deficiency. Three weeks after planting, each seedling was inoculated with 5000 eggs and second-stage juveniles ( $J_2$ ) of *H. sacchari*. This was accomplished by making four holes around the roots of each plant with a glass rod and dispensing 5 ml of nematode suspension containing 5000 eggs and  $J_2$  of *H. sacchari* taken from homogenized egg suspension with the aid of an Eppendorf pipette. Thereafter, the holes were covered with soil. The uninoculated plants served as the control, 5 ml of distilled water was added into the holes around the plants and the holes were covered with soil.

The experiment was arranged in the screenhouse in a Randomized Complete Block Design (RCBD) with four replicates. The plants were adequately watered throughout the period of the study. This experiment was repeated a second time without any modification. The experiment was terminated sixty days after inoculation. Plants in each pot were carefully upturned and adhering soil particles were gently removed from the roots prior to root examination and rating. Rice cultivars were rated 'susceptible' or 'resistant' to *H. sacchari* on the basis of number of cysts produced per plant as described by Cook and Noel (2002) (Table 3.1). Data were collected on shoot and root weights (g), number of white females, number of second-stage juvenile ( $J_2$ ) in soil and root, number of matured cysts in soil and root. Final nematode population per pot was determined by summing up the total number of white females in pot, total number of  $J_2$  in soil and root per pot, total number of matured cysts in soil and root per pot, total number of matured cysts in soil and root X average number of eggs and  $J_2$  per cyst.

Reproductive Factor (RF), determined by  $P_f/P_i$ ; where  $P_f$  = Final nematode population,  $P_i$  = initial nematode population (5000 eggs and  $J_2$ ) per plant was also calculated. Data on weight was taken using a METTLER PJ 3600 DeltaRange® balance, and nematode population was taken by counting using a compound microscope. The white females of *H. sacchari* on root were extracted by dislodging with a jet of water and collection over nested sieves of 2000  $\mu\text{m}$  and 250  $\mu\text{m}$ , respectively. Matured cysts were extracted from 250 ml of soil using the method described by Coyne *et al.* (2007) as previously described in Section 3.2. Cysts trapped on 250  $\mu\text{m}$  sieve were washed onto a filter paper held in a funnel and air-dried. Dried cysts were removed from organic debris using a damp camel hair brush under a Leica Wild M3C stereomicroscope.

Five grams (5 g) root sub-sample per pot was weighed and observed under a dissecting microscope in order to check for any adhering white females or matured cysts before second-stage juvenile extraction. The number of second-stage juveniles in 250 ml soil and total juveniles in roots were extracted using a modified Baermann extraction technique (Hooper, 1986) as previously described in Section 3.11.

**Table 3.1: Cyst production rating scale**

Number of Cysts per root system	Rating
0 = no cyst	(Resistant)
1 = 1-5 cysts	(Moderately Resistant)
2 = 6-10 cysts	(Moderately Susceptible)
3 = 11-30 cysts	(Susceptible)
4 = 31 cysts and above	(Highly susceptible)

Source: Cook and Noel (2002).



### **3.14 Experiment 2: Pathogenicity of *Heterodera sacchari* on growth and yield of rice**

#### **Pot experiment**

Pot trials were carried out in a screenhouse at the International Institute of Tropical Agriculture (IITA), Ibadan. Five NERICA rice cultivars namely; NERICA 1, NERICA 2, NERICA 3, NERICA 8 and NERICA 14 were used for this study. NERICA rice cultivars used for this trial were selected based on their ability to support *H. sacchari* reproduction as revealed by the screening trial. NERICA 1 and 2 have been released to farmers in Nigeria and are widely cultivated. The *H. sacchari* eggs and second-stage juvenile (J<sub>2</sub>) inoculum were extracted from cysts obtained from infested soil (Section 3.2). The inoculum (eggs and J<sub>2</sub>) were collected in a 500 ml beaker and then thoroughly mixed using a magnetic stirrer. An average of five counts was taken to estimate the egg and J<sub>2</sub> population per ml of the suspension under the stereomicroscope as previously described (Section 3.6). Three seeds of each NERICA rice cultivar were planted in a 5 l plastic pot containing steam-sterilized sandy loam soil. Two weeks after planting, rice seedlings were thinned to one stand per pot.

At three weeks after planting, rice seedlings were each inoculated at four inoculum densities: 0 (which served as control), 2,500, 5,000 or 10,000 eggs/J<sub>2</sub> per plant (i.e 0, 1 nematode per 2ml of soil, 1 nematode per ml of soil or 2 nematodes per ml of soil). This was accomplished by pipeting 0, 1, 2 or 4 ml of *H. sacchari* egg and J<sub>2</sub> suspension, respectively, into four holes made 4 cm deep at the base of the respective plants. Distilled water was introduced into the holes for 0 eggs / J<sub>2</sub>. After inoculation, the holes were covered with sterilized sandy-loam soil. Each treatment was replicated four times for each cultivar.

The pot experiment was a 5 x 4 factorial experiment (five cultivars of NERICA rice and four levels of *H. sacchari* inoculum) arranged in a Randomized Complete Block Design (RCBD) replicated four times. Immediately after inoculation, data were collected on plant height (cm), number of leaves and leaf chlorophyll content. The leaf chlorophyll content per plant was taken using a MINOLTA 502 SPAD meter. Subsequently, these data were collected weekly for eleven weeks.

Data on number of days to flowering per plant was also collected for the duration of the experiment. The plants were adequately watered throughout the period of the study.

At harvest, data were collected on plant height (cm), number of leaves per plant, leaf chlorophyll content, number of tillers, fresh shoot weight (g), fresh root weight (g), total seed weight (g) and weight of 50 seeds. Data on weight was taken using a METTLER PJ 3600 DeltaRange® balance. The root mass from each pot was separated from the soil by gently rinsing with tap water and thereafter observed for nematode root damage on a scale of 1-5 as described by Coyne *et al.* (2007), where 1= (no damage of rice root system), 2= (1- 10% of rice root system slightly damaged), 3= (11- 30% mild damage of rice root system), 4= (31-50% moderate damage of rice root system) and 5= (>51% severe damage of rice root system).

Population of juveniles in soil and root were determined from soil and rice roots, respectively. The soil from each pot was mixed properly, and then 250 ml of soil was measured in order to extract second-stage juveniles ( $J_2$ ) using the modified Baermann extraction technique, while the root samples were cut into 1-2 cm pieces, mixed properly and the modified Baermann extraction technique as described by Hooper (1986) was also used (see Section 3.11).

Number of white females from roots, and the number of cysts extracted from 250 ml of soil were also estimated. Cysts were extracted from soil using the method described by Coyne *et al.* (2007) as described previously in Section 3.2, while the white females of *H. sacchari* on root were dislodged with a jet of water and collected over nested sieves of 2000  $\mu\text{m}$  and 250  $\mu\text{m}$  apertures, respectively (Section 3.2).

Final nematode population per pot was determined by summing together total number of white females in pot, total number of  $J_2$  in soil and root/pot, total number of matured cysts in soil and root/pot, total number of matured cysts in soil and root/pot X average number of eggs and  $J_2$  per cyst.

Reproductive factor (RF) was determined by  $P_f/P_i$ ; where  $P_f$  = Final nematode population,  $P_i$  = initial nematode population (i.e. 5000 or 10000 eggs and  $J_2$ /plant, respectively). After this, roots and shoots were separately put in well-labelled envelopes and transferred into an oven to dry at a temperature of 80°C for 48 hours.

Data were taken on dry root and shoot weights. Data were analysed as previously described in Section 3.12. A repeat of this experiment was done without any modification.

### 3.14.1: Field experiment

A piece of land naturally-infested with *Heterodera sacchari* at Africa Rice Centre (ARC) field, Ikenne, Ogun State (Lat. 2° 67'N and 7° 97'N, Long. 6° 32'E, and 4° 40'E, at 60.8 m above sea level, average annual rainfall: 1480 mm, monthly mean temp. range: 18-24°C, soil type: Ultisol) was used for this study. The cyst nematode population obtained from the infected rice roots previously grown on the field was extracted and its identity was confirmed as *H. sacchari* at Biosystematics, ARC-PPRI, Pretoria, Republic of South Africa. Four beds, 15m long and 0.5 m wide, each with a spacing of 0.5m between rows were used for the study, each bed was then divided into two, each having a length of 7.5 m which gave rise to eight beds. Four beds served as control while the other four served as treatment plots (i.e *H.sacchari* infested-field). Each bed was further subdivided into five equal sub-plots. In order to maintain nematode population in the *H. sacchari*-infested plots, susceptible rice cultivar OS6 was planted two months before the commencement of the experiment. The control plots were denematized with carbofuran at 3 kg ai/ha. One week after denematization, 250 ml of soil was then collected from each sub-plot for extraction in order to determine the initial population ( $P_i$ ) of second stage juveniles ( $J_2$ ) and cysts of *H. sacchari* prior to planting. The modified Baermann extraction technique described by Hooper (1986) was used for  $J_2$  extraction from soil and cyst extraction from soil was carried out by the technique described by Coyne *et al.* (2007) as described in Section 3.2.

Five NERICA rice cultivars that were found to support *H. sacchari* reproduction namely; NERICA 1, NERICA 2, NERICA 3, NERICA 8 and NERICA 14 were used for this experiment. Six seeds of each cultivar were planted in each sub-plot at the spacing of 0.25 m x 0.25 m, such that each main-plot had the five NERICA rice cultivars randomly planted within it. The experimental design was a split-plot design with nematode-infested and nematode-free as the main-plots; and the five NERICA rice cultivars as sub-plots, replicated four times (Fig. 3.1).

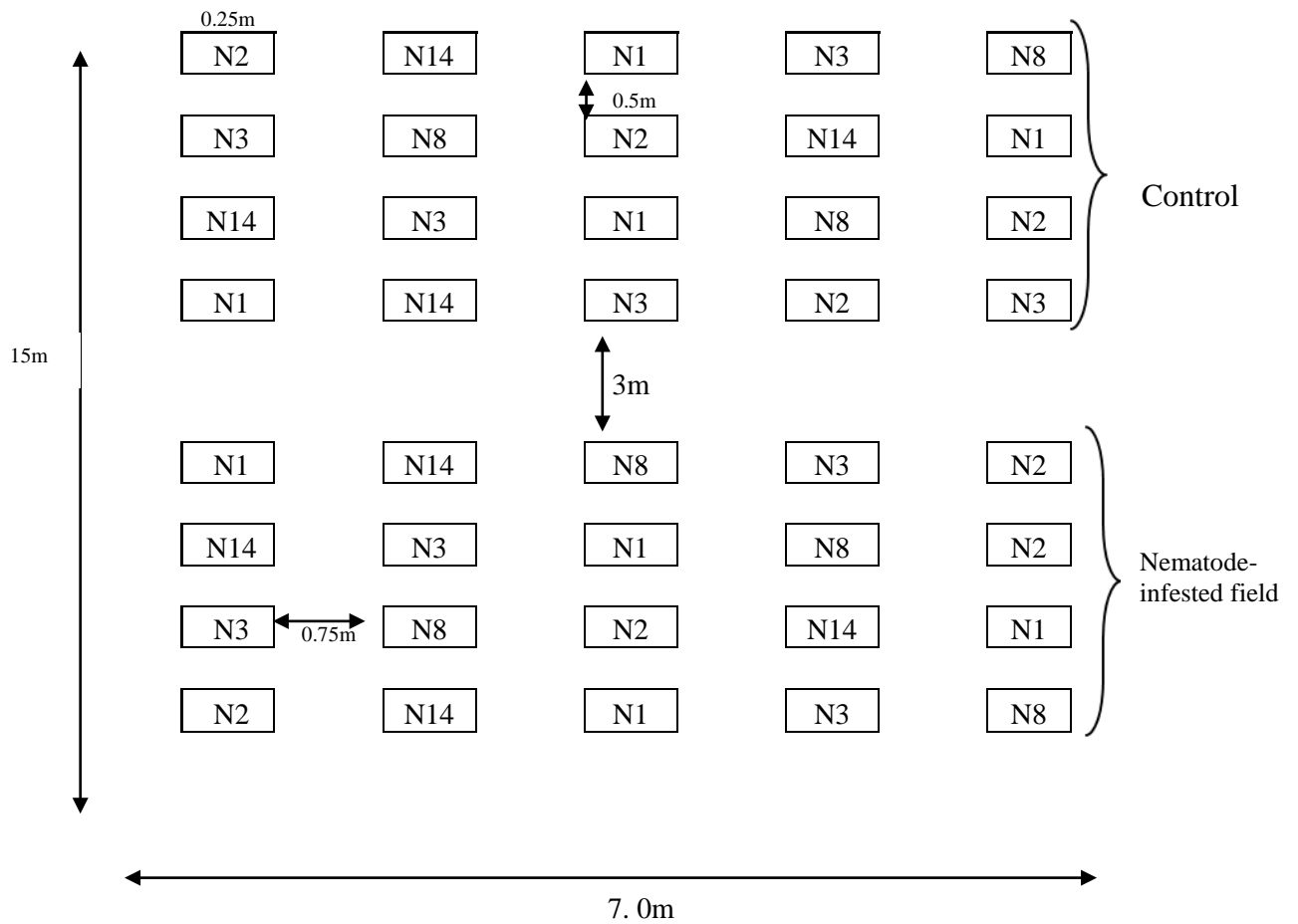

**Fig 3.1: Field layout of pathogenicity experiment at Ikenne, Ogun State**

N = NERICA rice

Cyst and J<sub>2</sub> populations were estimated by counting under the stereomicroscope or compound microscope, respectively. The experiment was carried out in the rainy seasons (May to August) of 2010 and 2011, respectively.

Data were collected on plant height, leaf chlorophyll content and number of leaves per plant. The leaf chlorophyll content was measured with the aid of a MINOLTA 502 SPAD meter. Data were collected at four weeks after planting and subsequently fortnightly until the twelfth week after planting. Data on days to flowering per plant was also collected from seven, eight and nine weeks after planting.

At harvest, data were collected on plant height (cm), number of leaves per plant, leaf chlorophyll content, number of tillers, fresh shoot weight (g), fresh root weight (g), total seed weight (g), weight of 50 seeds. A METTLER PJ 3600 DeltaRange® balance was used for taking data on weight parameters. The root mass from each plant was separated from the soil by gently rinsing with water and thereafter observed for nematode root damage on a scale of 1-5 as described by Coyne *et al.* (2007) as previously used in the pot pathogenicity experiment (Section 3.14). Number of white females on root, number of cysts from soil and roots were determined. Nematode population (J<sub>2</sub>) was also determined from root and soil, respectively.

Soil from where rice plant was uprooted per plot was mixed together with a hand trowel, and then, 250 ml of the soil was measured with a beaker and the modified Baermann extraction technique described by Hooper (1986) was used to extract second-stage juveniles (see Section 3.11). White females of *H. sacchari* on roots were dislodged with a jet of water and collected over nested sieve of 2000 µm and 250 µm respectively, number of cysts in 250 ml of soil were extracted using the method described by Coyne *et al.* (2007) as previously described in Section 3.2.

Five grams (5g) root sub-sample was weighed and observed under a dissecting microscope to check for any adhering white females or matured cysts before second-stage juvenile extraction. After this, roots and shoots were separately put in well-labelled envelopes and transferred into an oven set at a temperature of 80°C for 48 hours to dry. Data were taken on dry root and shoot weights. This experiment was repeated a second time without any modification. Data were analysed as previously described in Section 3.12.

### **3.15 Experiment 3: Studies of the relationship between *Heterodera sacchari* and *Botryodiplodia theobromae* and their effect on the growth and yield of rice.**

#### **3.15.1 Pot experiment**

The pot trials were carried out in the screenhouse at International Institute of Tropical Agriculture (IITA), Ibadan (Lat. 7° 3'N, 3° 45'E at 232.5 m above sea level). Two (2) NERICA rice cultivars namely; NERICA 1 and NERICA 2 were used for this study. Cultivars were selected on the basis of their ability to support *H. sacchari* reproduction as revealed by the screening trial and also their wide cultivation in Nigeria. The inoculum of *H. sacchari* eggs and second-stage juveniles (J<sub>2</sub>) used for this study were extracted from cysts recovered from infested soil of the pathogenicity trials. The eggs and J<sub>2</sub> were extracted using the method described by Coyne *et al.* (2007) in Section 3.2. The eggs and J<sub>2</sub> were collected in a 500 ml beaker and then thoroughly mixed using a magnetic stirrer. The population per ml of eggs and J<sub>2</sub> suspension were estimated under the stereomicroscope in a counting dish. The average of five counts was used as an estimate of the number of nematodes per ml (Sections 3.5 and 3.6). The *B. theobromae* spores used were isolated from rice roots infected by *H. sacchari* from which pure cultures were prepared as previously described in Section 3.9. Spore population per ml was determined as described in Section 3.10.

Three seeds of each NERICA rice cultivar were planted in a plastic pot containing 5 litres of steam-sterilized sandy loam soil. Two weeks after planting, rice seedlings were thinned to one seedling per pot. Three weeks after planting, rice seedlings were inoculated as follows:

- (a) 0 (which served as control),
- (b) 5000 eggs and J<sub>2</sub> of *H. sacchari* alone,
- (c) 5X10<sup>5</sup> spores ml<sup>-1</sup> of *B. theobromae* alone,
- (d) 5000 eggs and J<sub>2</sub> of *H. sacchari* + 5X10<sup>5</sup> spores ml<sup>-1</sup> of *B. theobromae* one week later,
- (e) 5X10<sup>5</sup> spores ml<sup>-1</sup> of *B. theobromae* + 5,000 eggs and J<sub>2</sub> of *H. sacchari* a week later,
- (f) 5000 eggs and J<sub>2</sub> of *H. sacchari* + 5X10<sup>5</sup> spores ml<sup>-1</sup> of *B. theobromae* inoculated simultaneously per plant.

This was accomplished by pipetting 1 ml of distilled water which served as the control (0) or 2 ml of *H. sacchari* eggs and J<sub>2</sub> suspension and/or 1 ml of *B. theobromae* spore and/or suspension, respectively into four holes each 4 cm deep made at the base of the plants. Distilled water was introduced into the holes for 0 eggs. After inoculation, the holes were covered with sterilized sandy-loam soil. Each treatment was replicated four times for each cultivar. The pot experiment was a 2 X 6 factorial experiment (two cultivars of NERICA rice and six treatments of *H. sacchari* or *B. theobromae* inoculum) in a Randomized Complete Block Design (RCBD). Immediately after inoculation, data were collected on plant height, number of leaves and leaf chlorophyll content. Subsequently, these data were collected weekly for the duration of the experiment. The leaf chlorophyll content was taken using a MINOLTA 502 SPAD meter per plant. Number of days to flower was taken per plant. The plants were adequately watered throughout the period of the study.

At harvest (eleventh week), data were collected on plant height (cm), number of leaves per plant, leaf chlorophyll content, number of tillers, number of panicles, fresh shoot weight (g), fresh root weight (g), total seed weight (g), weight of 50 seeds. Data on weight parameters were taken using a METTLER PJ 3600 DeltaRange® balance. The root mass from each pot was separated from the soil by gently washing with tap water and thereafter observed for nematode root disease index on a scale of 0-5 as described by Nordmeyer and Sikora (1983) where 0 = No visible lesions, 1 = Lesions 1 mm long, light brown, 2 = Lesions 1 to 5mm long, brown, 3 = Lesions longer than 5mm, dark brown, 4 = Root totally infected and brown, 5 = Root totally destroyed and plant dying or dead.

Final nematode population was also determined as previously described in Section 3.14. Data were analysed as previously described in Section 3.12. The second trial of this experiment was carried out without any modifications.

### **3.15.2 Microplot experiment**

Microplot trials were carried out at the International Institute of Tropical Agriculture (IITA), Ibadan. Two NERICA rice cultivars NERICA 1 and 2 selected on the basis of their ability to support *H. sacchari* reproduction, and their wide cultivation in Nigeria were used for this study. The *H. sacchari* eggs and second-stage juveniles (J<sub>2</sub>) used for this study were extracted from infested soil by the method described by Coyne *et al.*

(2007) (Section 3.4). The eggs and J<sub>2</sub> were collected in a 500 ml beaker and then thoroughly mixed using a magnetic stirrer. The population per ml of eggs and juvenile in suspension was estimated under the stereomicroscope in a counting dish and the average of five counts was taken. The *B. theobromae* spores used were obtained from pure *B. theobromae* culture isolated from rice roots infected by *H. sacchari* as described in Sections 3.9 and 3.10. Three seeds of each NERICA rice cultivar were planted in a polyethylene bags containing 50 litres of steam-sterilized sandy loam soil. These bags were placed in the field plot of the Nematology laboratory, IITA, Ibadan. Two weeks after planting, rice seedlings were thinned to one seedling per microplot. Three weeks after planting, seedlings were inoculated as follows:

- (a) 0 (which served as control),
- (b) 50,000 eggs and J<sub>2</sub> of *H. sacchari* alone,
- (c) 5.0X10<sup>6</sup> spores ml<sup>-1</sup> of *B. theobromae* alone,
- (d) 50,000 eggs and J<sub>2</sub> of *H. sacchari* + 5.0X10<sup>6</sup> spores ml<sup>-1</sup> of *B. theobromae* one week later,
- (e) 5.0X10<sup>6</sup> spores ml<sup>-1</sup> of *B. theobromae* + 50,000 eggs and J<sub>2</sub> of *H. sacchari* a week later,
- (f) 50,000 eggs and J<sub>2</sub> of *H. sacchari* + 5.0X10<sup>6</sup> spores ml<sup>-1</sup> of *B. theobromae* inoculated simultaneously/plant.

This was accomplished by pipetting distilled water which served as the control (0) or 10 ml of *H. sacchari* eggs and J<sub>2</sub> suspension and 1 ml of *B. theobromae* spore suspension, respectively into four holes each 4 cm deep made at the base of the plants. Distilled water was introduced into the holes for control (0 eggs and juveniles/plant). After inoculation, the holes were covered with sterilized sandy-loam soil. Each treatment was replicated four times for each cultivar. The microplot experiment was a 2 X 6 factorial design (two cultivars of NERICA rice and six treatments of *H. sacchari* and *B. theobromae* inoculum) arranged in a Randomized Complete Block Design (RCBD) in the field at a spacing of 0.5 m within and between the rows. Weeding was carried out adequately throughout the experiment. The microplot was laid out as shown in Figure 3.2.

Immediately after inoculation, data were collected on plant height and number of leaves per plant. Leaf chlorophyll content was taken using a MINOLTA 502 SPAD meter.



Subsequently, these data were collected weekly for eleven weeks after which the experiment was terminated.

At harvest, data were collected on plant height (cm), number of leaves per plant, leaf chlorophyll content, number of tillers, number of panicles, fresh shoot weight (g), fresh root weight (g), total seed weight (g), weight of 50 seeds. Data on weight parameters were taken using a METTLER PJ 3600 DeltaRange® balance. Number of days to flower was taken from seven weeks after planting until the end of the experiment. The root mass from each pot was separated from the soil by gently washing with tap water and thereafter observed for nematode root disease index on a scale of 0-5 as described by Nordmeyer and Sikora (1983) as previously described in Section 3.15.1. Final nematode population was also determined as previously described in Section 3.14. Data were analysed as previously described in Section 3.12. The second trial of this experiment was carried out without any modification.

### **3.16 Experiment 4: Histopathology of NERICA rice roots infected with *Heterodera sacchari***

Eighty 5-litre plastic pots filled with steam-sterilized soil were used for this study. The pots were arranged in 20 x 4 rows on concrete floor in the screenhouse at International Institute of Tropical Agriculture (IITA), Ibadan and spaced one meter within and between the rows. Two seeds of *H. sacchari*-susceptible NERICA 1 were planted in each pot. Two weeks after planting, seedlings were thinned to one per pot. The nematode eggs and second-stage juvenile ( $J_2$ ) used for this work were extracted from cysts isolated from infested soil as described in Sections 3.2 and 3.3. The population of eggs and juvenile in suspension was estimated under the stereomicroscope by counting from 1 ml aliquot in a counting dish and the average of five counts was taken.

The NERICA rice seedling in each pot was inoculated with 5,000 freshly extracted *H. sacchari* eggs and  $J_2$  at three weeks after planting by exposing the roots and dispensing the eggs on the roots with the aid of an Eppendorf pipette. The roots were covered up with the soil inside the pots immediately after inoculation. Twenty-four hours after inoculation, and subsequently daily for 35 days when the experiment was terminated, two inoculated and two uninoculated rice plants were randomly and carefully uprooted, washed in a gentle stream of water and dried between paper towels.

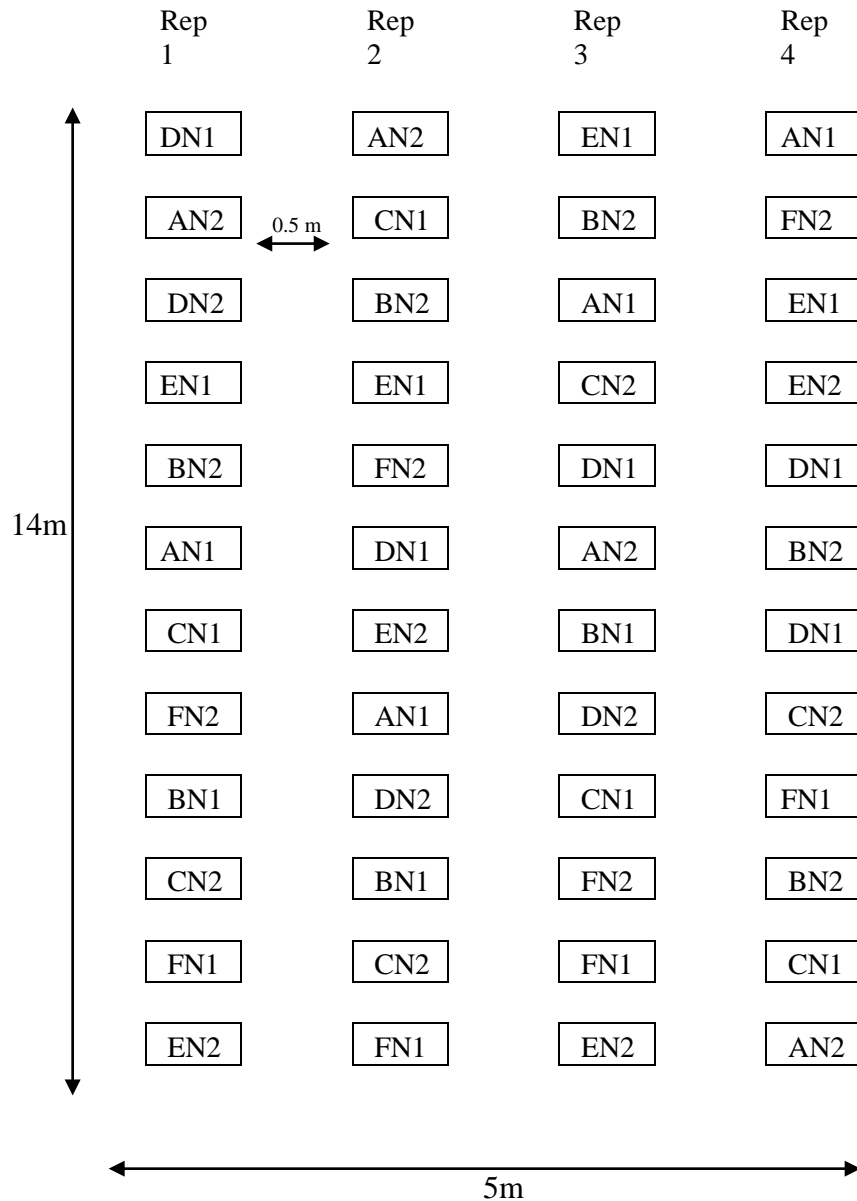

Fig. 3.2: Microplot Layout in the field.

Treatments were:

A= Control, B=50,000 eggs and  $J_2$  of *H. sacchari*, C=  $5.0 \times 10^6$  spores  $ml^{-1}$  of *B. theobromae*  
D=50000 eggs and  $J_2$  of *H. sacchari* +  $5.0 \times 10^6$  spores  $ml^{-1}$  of *B. theobromae* one week later  
E= $5.0 \times 10^6$  spores  $ml^{-1}$  of *B. theobromae* + 50000 eggs and  $J_2$  of *H. sacchari* a week later,  
F=50000 eggs and  $J_2$  of *H. sacchari* +  $5.0 \times 10^6$  spores  $ml^{-1}$  of *B. theobromae* inoculated simultaneously/plant, Rice cultivars; NERICA 1 (N1), NERICA 2(N2)

The roots were then cut into approximately 4 to 5 centimeters pieces. The root pieces were submerged in 10 ml fixative contained in a specimen bottle. The formalin-propiono-propanol (FPP) fixative used was prepared thus: 90 ml of 50% isopropyl alcohol + 50 ml propionic acid + 50 ml 37% formaldehyde in separate Kilner jars securely corked and appropriately labelled. The fixed infected root segments were dehydrated in graded isopropyl alcohol (IPA) series viz: 70%, 90%, and 100% for 72 hours in each concentration. The dehydrated tissues were infiltrated with paraffin wax by pouring off part of the 100% IPA in the last dehydration step such that the root tissues in the bottom of the container remained covered with IPA. The container was then filled with chips of paraffin wax and placed uncovered in an oven set at 60<sup>0</sup>C. Once the chips had melted, the paraffin-IPA mixture was poured off and replaced with pure melted paraffin wax. This paraffin was exchanged for freshly melted paraffin twice at 3 to 4 day intervals. One week after infiltration process, the tissues were embedded in molten paraplast (Sherwood Medical Industries, U.S.A) so that they could be sectioned after hardening. After the paraplast had cooled and solidified, the tissue blocks were made and trimmed. Transverse and longitudinal sections 14 µm thick were cut with a rotary microtome equipped with a disposable razor blade (Minot – Microtome Type 1212, Ernest Leitz GMBH, WETZLAR, Germany). The sections were floated out in a water bath and the sections were picked up with a pre-coated microscope slide, labeled and taken to the oven for drying. The sections were stained in safranin O and counterstained in fast green (Daykin and Hussey, 1985). All sections were mounted in DPX (a colourless synthetic resin mounting medium containing Distyrene, Plasticizer and Xylene) prior to examination with a compound microscope. Data were collected on average number of nuclei per syncytium and this was processed using Microsoft Excel (2003). Observations were made on cellular structural integrity (compression, disorganisation and disintegration), nematode development and formation of syncytium

### 3.17 Experiment 5: Histopathology of NERICA 1 rice roots infected by *Heterodera sacchari* and *Botryodiplodia theobromae* in various inoculation sequences

Four hundred and twenty 5-l plastic pots filled with steam-sterilized soil were used for this study. The pots were arranged in 10 X 7 rows (for each set of treatments) on a concrete floor in the screenhouse at the International Institute of Tropical Agriculture (IITA), Ibadan and spaced at 50 cm within and between the rows. Two seeds of *H. sacchari*-susceptible NERICA 1 cultivar were planted in each pot. Two weeks after planting, seedlings were thinned to one stand per pot. The nematode eggs and second-stage juvenile (J2) used for this work were extracted from cysts isolated from infested soil (Sections 3.2 and 3.3). The population of eggs and juvenile in suspension was estimated under the stereomicroscope by counting from 1 ml aliquots in a counting dish and the average of five counts was taken. The *B. theobromae* spores used were obtained from pure *B. theobromae* culture isolated from rice roots as described in Sections 3.9 and 3.10.

At three weeks after planting, NERICA 1 rice seedling in each pot was inoculated with the following treatments;

- (a) Control (0),
- (b) 5,000 freshly extracted *H. sacchari* eggs and juveniles alone,
- (c)  $5 \times 10^5$  spores  $\text{ml}^{-1}$  of *B. theobromae* alone,
- (d) 5000 eggs and J2 of *H. sacchari* +  $5 \times 10^5$  spores  $\text{ml}^{-1}$  of *B. theobromae* one week after the nematode inoculation,
- (e)  $5 \times 10^5$  spores  $\text{ml}^{-1}$  of *B. theobromae* + 5,000 eggs and J2 of *H. sacchari* a week after the fungus inoculation,
- (f) 5000 eggs and J2 of *H. sacchari* +  $5 \times 10^5$  spores  $\text{ml}^{-1}$  of *B. theobromae* inoculated simultaneously/plant.

This was done by exposing the roots and dispensing the inoculum on the roots with the aid of an Eppendorf pipette. The roots were covered up with sterile soil inside the pots immediately after inoculation. However, the exposed roots of the control plants were inoculated with distilled water and the roots were immediately covered with sterile soil inside the pots. All the treatments were applied using separate sterile Eppendorf pipettes.

Twenty-four hours after inoculation, and subsequently everyday for 35 days when the experiment was terminated, two inoculated and two uninoculated plants were uprooted and processed as previously described in Section 3.16. Data collected on average number of nuclei per syncytium were processed using Microsoft Excel (2003). Observations were made on cell structural integrity, viz; cellular compression, disorganisation and disintegration; formation of syncytium and number of nuclei per syncytium, development of the nematode and fungus fruiting bodies.

## CHAPTER FOUR

### RESULTS

#### 4.0

#### 4.1: Screening of rice cultivars for resistance to cyst nematode (*Heterodera sacchari*)

The 25 rice cultivars evaluated for resistance to cyst nematode exhibited differences in their host status to *H. sacchari*. The cyst production rating, Reproductive Factor (RF =  $P_f/P_i$ ), fresh root and shoot weight reduction also varied across rice cultivars. The cyst production, RF and also fresh root and shoot weight reduction, were the criteria upon which rating for resistance to *H. sacchari* was based. The cyst production rating was significantly ( $P \leq 0.05$ ) higher in both *O. sativa* and NERICA rice cultivars (except NERICA 6 and NERICA 8) than CG14. The cyst production rating of 2.7 was obtained for NERICA 10, while 4.0 was obtained for NERICA 1, 7, 14, 17, WAB 56-50, ITA 150 and OS6 rice cultivars, respectively. The least cyst production rating of 0.3, 1.2 and 1.4 were obtained in CG14, NERICA 8 and 6, respectively (Table 4.1).

The total number of second-stage juveniles in soil and root and total number white females, total number of cyst in soil recovered from pot of NERICA rice and *O. sativa* rice cultivars were significantly ( $P \leq 0.05$ ) higher than the those obtained from NERICA 6, 8 and CG14, respectively.

The highest RF (614.8) was observed in OS6 rice cultivar, and this was significantly different ( $P \leq 0.05$ ) from the RF obtained for NERICA rice and *O. sativa* rice cultivars. The RF of NERICA rice cultivars ranged from 118.4 in NERICA 12 to 434.4 in NERICA 7, and the *Oryza sativa* cultivars (LAC 23, Moroberekan, ITA 150, WAB 56-50, WAB 56-104, Suakoko 8) had RF between 75.3 and 481.3 and these were significantly ( $P \leq 0.05$ ) higher than CG 14, NERICA 6 and 8 rice cultivars, respectively. The RF obtained in CG14, NERICA 6 and 8 ranged from 0.3 to 4.4, respectively (Table 4.1).

**Table 4.1: Reproduction of *Heterodera sacchari* on 24 cultivars of rice 60 days after inoculation.**

Cultivar	Cyst production rating *	Total number of J2 in pot (soil)	Total number of J2 in root	Total white females in pot	Total cysts in soil	Eggs+J2/ Cyst	Total eggs & J2 population in cysts	Total <i>H. sacchari</i> population/ pot	Reproductive factor***	Host status****
NERICA1 (P)	4.0**	35750.0	615.7	87997.5	3968.8	230.6	943625.0	1067988.2	213.6	S
NERICA2 (P)	2.9	8750.0	411.9	89525.7	4218.8	211.9	952000.0	1050687.5	210.2	S
NERICA3 (P)	3.9	27812.5	933.8	81293.8	9843.8	201.8	2047687.5	2157727.5	431.6	S
NERICA4 (P)	3.5	19062.5	656.9	102271.9	4734.4	207.3	972062.5	1094053.8	218.8	S
NERICA5 (P)	3.0	58437.5	780.0	95845.0	2671.9	184.2	586718.8	741781.3	148.4	S
NERICA6 (P)	1.4	3437.5	375.0	815.6	85.0	51.3	17425.0	22053.2	4.4	MR
NERICA7 (P)	4.0	38437.5	1100.0	174025.0	6562.5	282.8	1958078.1	2171640.7	434.4	S
NERICA8 (P)	1.2	365.0	226.3	3573.2	93.8	25.4	8375.0	12539.2	2.5	MR
NERICA9 (P)	2.8	21041.6	987.5	48365.7	8312.5	247.1	1907187.5	1978207.3	395.7	S
NERICA10 (P)	2.7	38646.3	983.8	78997.5	2106.3	190.4	480552.5	599178.8	119.5	S
NERICA11 (P)	3.5	25812.5	519.4	133641.9	5375.0	222.0	1139843.8	1299817.6	260.0	S
NERICA12 (P)	3.0	40312.5	650.0	218966.3	1296.9	225.8	331828.2	591756.9	118.4	S
NERICA14 (P)	4.0	33125.0	818.8	132518.8	6000.0	251.2	1561031.3	1727493.8	345.5	S
NERICA16 (P)	3.9	30937.5	1818.8	118887.5	6072.7	241.1	1537750.0	1689393.8	337.9	S
NERICA17 (P)	4.0	30000.0	745.7	191003.	3812.5	206.7	957500.0	1179248.8	235.9	S
NERICA18 (P)	3.0	12500.0	527.5	164658.2	1828.2	245.2	464437.5	642123.2	128.4	S
LAC23 (OS)	3.9	67500.0	965.7	249881.3	6171.9	262.4	1640593.8	1958940.7	391.8	S
Moroberekan (OS)	3.6	38750.0	831.3	157071.9	7781.3	280.9	2209500.0	2406153.2	481.3	S
WAB56-50 (OS)	4.0	71250.0	1121.9	224928.2	4390.7	282.8	1247687.5	1544987.5	309.0	S
ITA150 (OS)	4.0	26562.5	837.5	239340.7	5609.4	246.0	1449171.9	1715912.5	343.2	S
WAB56-104 OS (Parent)	3.6	13635.0	390.7	101543.2	1781.3	227.8	378437.5	495057.5	99.1	S
Suakoko 8 (OS)	2.9	12875.0	292.5	84290.7	1421.9	190.2	278750.0	376208.2	75.3	S
CG14 Og (Parent)	0.3	0.0	0.0	0.0	18.3	29.5	1472.5	1491.5	0.3	R
OS6 (OS)	4.0	110312.5	1441.3	207194.4	10000.0	272.4	2755000.0	3073948.2	614.8	S
LSD P≤0.05	1.1	63673.8	987.25	155567	4174.0	74.7	1.1 X 10 <sup>6</sup>	1.2 X 10 <sup>6</sup>	236.9	

\*cyst production rating= 0 = no cyst, 1 = 1-2 cysts, 2 = 3-10 cysts, 3 = 11–30 cysts, 4 = 31 cysts and above, \*\* = mean of 8 replicates, P= Interspecific progeny (WAB 56-104 X CG14), OS= *Oryza sativa*, Og = *Oryza glaberrima*, \*\*\*Reproductive Factor (RF) = Pf/Pi where Pf = final nematode, Pi = 5,000 eggs and second-stage juvenile (J2) / plant, \*\*\*\* Host status: R= Resistant, MR= moderately resistant, MS = moderately susceptible, S = susceptible, Highly susceptible, LSD for comparing means within the same column.

On the basis of cyst production rating, reproductive factor and also supported with root and shoot reduction, the 24 rice cultivars screened for resistance were classified thus: *O. sativa* and NERICA cultivars (except NERICA 6, 8 and CG14) were found to support reproduction and multiplication of *H. sacchari* with subsequent fresh root and shoot reduction were classified as susceptible (S). NERICA 6 and 8 were classified as moderately resistant (MR) while CG14 was classified as resistant (R) as presented in Table 4.1.

The above findings were further supported by percentage root and shoot weights reduction which varied among rice cultivars due to the presence of *H. sacchari*. Significant reductions ( $P \leq 0.05$ ) of both fresh root and shoot were observed among rice cultivars following *H. sacchari* inoculation compared with the control (Table 4.2). The percentage root weight reduction ranged from 8.6%-59.8% in the NERICA rice cultivars. Among the *O. sativa* rice cultivars, WAB 56-50 had the least percentage root weight reduction of 8.4% while the highest percentage root weight reduction of 62.6% was recorded for Suakoko 8 compared with CG14 with root weight reduction of 12.4% (Table 4.2). In the NERICA rice cultivars, the least percentage shoot weight reduction was 10.2% (NERICA 8) and the highest was 54.4% (NERICA 11) compared to CG14 with the percentage shoot weight reduction of 3.0% (Table 4.2). The means of the data collected in the two trials were not significantly different ( $P \leq 0.05$ ). Therefore, the data were combined for analysis and their means presented (Tables 4.1 and 4.2).

#### **4.2: Pathogenicity of *Heterodera sacchari* on NERICA rice in pots**

##### **4.2.1: Effects of various inoculum densities of *H. sacchari* on vegetative growth of NERICA rice from inoculation to eleventh week.**

There were no significant differences in the mean height of NERICA rice cultivars at different nematode population levels of 2,500, 5,000 and 10,000 eggs/J2 by the fourth week. As from eight weeks after inoculation (WAI), the inoculated plants were significantly reduced ( $P \leq 0.05$ ) in height than the control in the two trials. The effect of the treatment was observed on plant height from five WAI in the first trial (Fig. 4.1a) and seven WAI in the second trial (Fig. 4.1b). This trend continued till eleventh week after inoculation in the two trials.



**Table 4.2: Effect of *Heterodera sacchari* inoculation on fresh root and shoot weights of rice 60 days after inoculation**

Cultivar	Fresh root weight (g)				Fresh shoot weight (g)			
	Control	Inoculated	P-value	% root reduction	Control	Inoculated	P-value	% shoot reduction
NERICA 1	37.9*	17.3	<.0001s	54.4	34.5*	16.8	0.001 s	51.3
NERICA 2	51.1	31.3	0.02s	38.8	44.3	30.7	0.02s	30.7
NERICA 3	38.1	23.9	0.001s	37.3	39.3	24.9	<.0001s	36.6
NERICA 4	39.4	20.5	0.01s	48.0	42.1	19.5	0.05s	53.7
NERICA 5	45.7	20.0	0.0004s	56.2	42.6	26.4	0.02s	38.0
NERICA 6	27.7	23.2	0.5ns	16.2	25.7	21.7	0.6ns	15.7
NERICA 7	22.4	16.1	0.4ns	28.1	36.3	28.3	0.002s	22.0
NERICA 8	29.4	26.4	0.6ns	10.2	25.5	22.9	0.62ns	10.2
NERICA 9	25.3	12.2	0.05s	51.8	35.4	17.5	0.03s	50.6
NERICA 10	40.0	22.2	0.0002s	44.5	41.5	24.3	0.002s	41.5
NERICA 11	52.1	24.3	0.01s	53.4	50.2	22.9	0.0007s	54.4
NERICA 12	44.4	25.4	0.0002s	42.8	52.8	39.3	0.0002s	25.6
NERICA 14	46.4	31.7	0.002s	31.7	42.7	28.3	0.002s	33.7
NERICA 16	34.9	31.9	0.8ns	8.6	42.3	32.6	0.02s	22.9
NERICA 17	17.9	7.2	0.002s	59.8	36.0	17.3	0.02s	51.9
NERICA 18	21.8	16.0	0.3ns	26.6	29.3	23.2	0.4ns	20.8
LAC 23	36.4	25.9	0.02s	28.9	38.3	26.0	0.01s	32.1
Moroberekan	34.5	31.7	0.001s	37.1	29.9	25.8	0.003s	47.2
WAB 56-50	29.8	27.3	0.6ns	8.4	35.4	27.3	0.03s	22.9
ITA 150	20.0	11.4	0.07s	43.0	29.1	17.8	0.06s	38.8
WAB 56-104	40.7	17.5	0.07s	57.0	37.4	17.9	0.007s	52.1
Suakoko 8	38.2	14.3	0.005s	62.6	43.5	17.6	0.02s	59.5
CG14	46.0	40.3	0.6ns	12.4	39.6	38.4	0.8ns	3.0
OS 6	53.6	32.4	0.02s	39.6	46.6	38.6	0.002s	17.2

% root reduction = (Mean of Control- Mean of Inoculated) X 100/ Mean of Control; OS= *Oryza sativa*; Og = *Oryza glaberrima*; P= Interspecific progeny (WAB 56-104 X CG14), P-value comparing for treatment means (control and inoculated plant) within the same row, s = significant, ns = not significant, \* = mean of 8 replicates

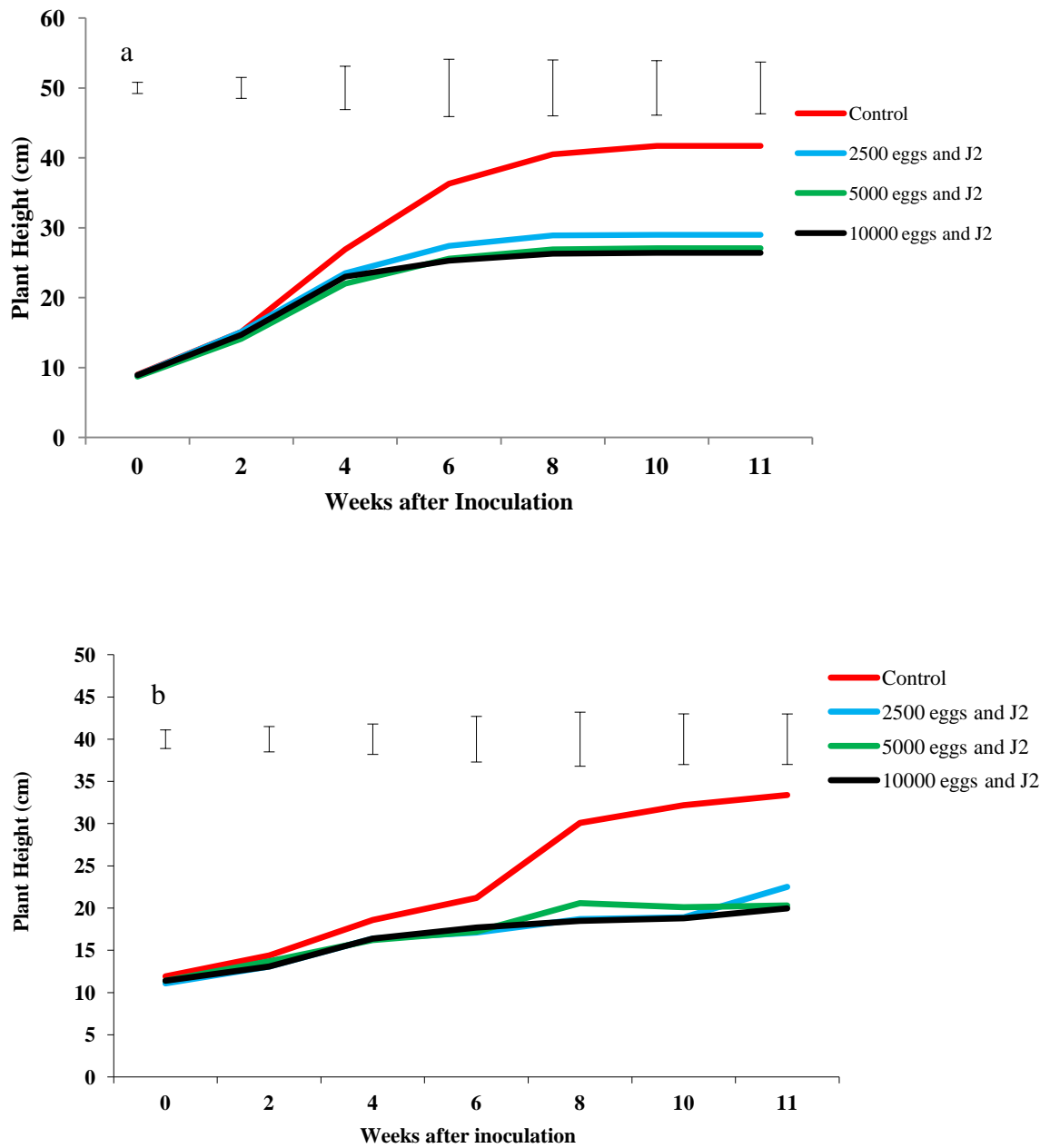

**Fig. 4.1: Effect of *Heterodera sacchari* population densities on height of NERICA rice after inoculation. a = first trial, b = second trial.**

LSD bars are for comparing treatment means at each specific time, J<sub>2</sub> = second-stage juveniles

The mean numbers of leaves produced by rice plants were not significantly different ( $P \leq 0.05$ ) for the two trials run for this experiment. Rice plants inoculated with 2,500, 5,000 and 10,000 eggs/second-stage juveniles ( $J_2$ ) produced significantly fewer ( $P \leq 0.05$ ) leaves than plants that were uninoculated (Figs. 4.2a and 4.2b). The effect of inoculation was observed from six weeks after inoculation (WAI) in the first trial (Fig. 4.2a) and four WAI in the second trial (Fig. 4.2b). At 11 WAI, the number of leaves produced by the inoculated rice plants was significantly fewer ( $P \leq 0.05$ ) than those obtained from uninoculated rice plants in the two trials (Fig. 4.2a and 4.2b).

There were no significant differences ( $P \leq 0.05$ ) in the leaf chlorophyll content of the inoculated and the uninoculated plants by the sixth week after inoculation in the two trials run for this experiment. In the first trial, NERICA rice plants inoculated with 10,000 eggs/ $J_2$  was significantly ( $P \leq 0.05$ ) lower in leaf chlorophyll content than uninoculated rice plants six weeks after Inoculation WAI (Fig. 4.3a). The effect of inoculation was observed on the inoculated plants from six WAI in the first trial and four WAI in the second trial (Figs. 4.3a and 4.3b). From eight to 11 WAI, leaf chlorophyll content reduced significantly in the inoculated plants (18.9, 18.1 and 17.6) when compared with the uninoculated plants with mean chlorophyll content of 33.9 (Fig. 4.3a). Leaf chlorophyll content decreased rapidly with increasing nematode inoculum density from eight to ten weeks after inoculation (Figs. 4.3a and 4.3b).

#### **4.2.2: Effects of *Heterodera sacchari* population densities on growth and yield of five NERICA rice cultivars**

The inoculated NERICA rice plants were significantly shorter ( $P \leq 0.05$ ) in height than the uninoculated plants in the two trials (Figs. 4.4a and 4.4b). All the NERICA rice cultivars inoculated with 10,000 eggs and  $J_2$  were significantly shorter ( $P \leq 0.05$ ) in height than the uninoculated NERICA rice cultivars. NERICA 2 rice cultivar inoculated with 5,000 and 10,000 eggs /  $J_2$  had the lowest plant height and this was significantly different ( $P \leq 0.05$ ) from inoculated NERICA rice 1, 3, 8 and 14 at eleven WAI. The control of NERICA 14 was the tallest in height which was closely followed by NERICA 8, NERICA 3, NERICA 1 and NERICA 2, respectively (Fig 4.4a). Plant height decreased rapidly with increasing inoculum density at 11 weeks after inoculation in the two trials (Figs 4.4a and 4.4b).

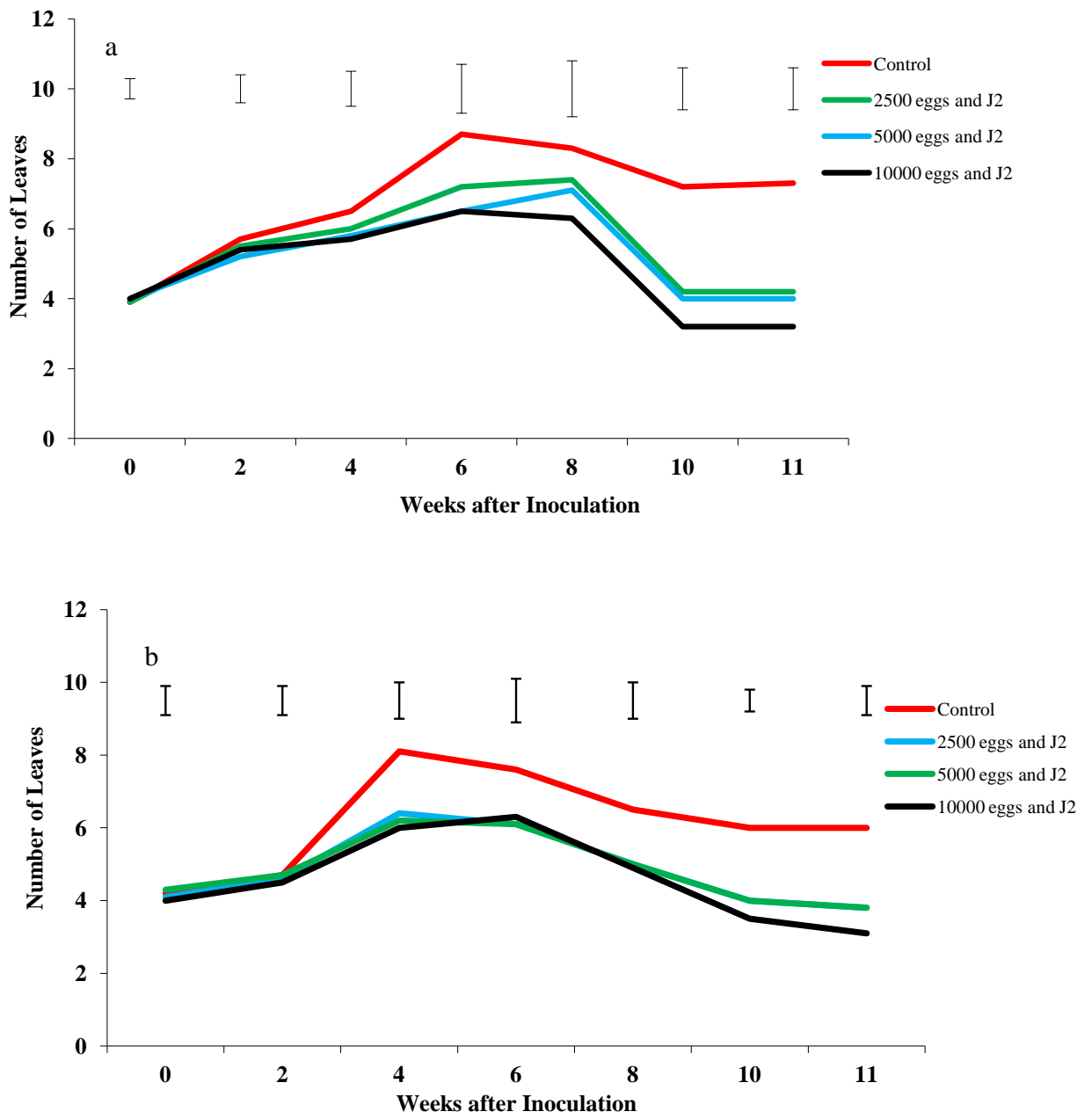

**Fig. 4.2: Effects of *Heterodera sacchari* population densities on leaf production of NERICA rice after inoculation. a = first trial, b = second trial.**

LSD bars are for comparing treatment means at each specific time. J2 = second-stage juveniles

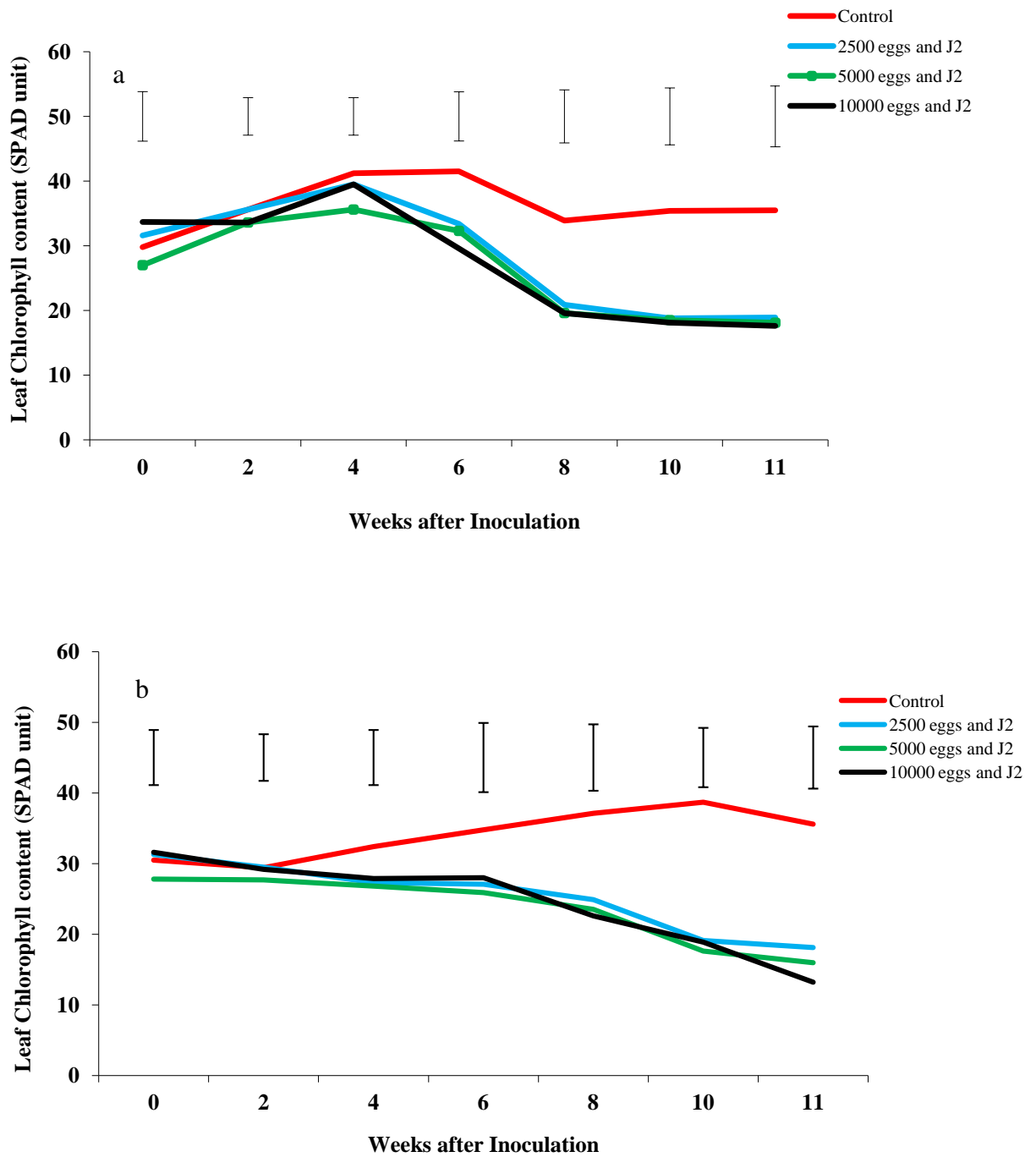

**Fig. 4.3: Effects of *Heterodera sacchari* population densities on leaf chlorophyll content of NERICA rice after inoculation. a = first trial, b = second trial.**

LSD bars are for comparing treatment means at each specific time. J2 = second-stage juveniles

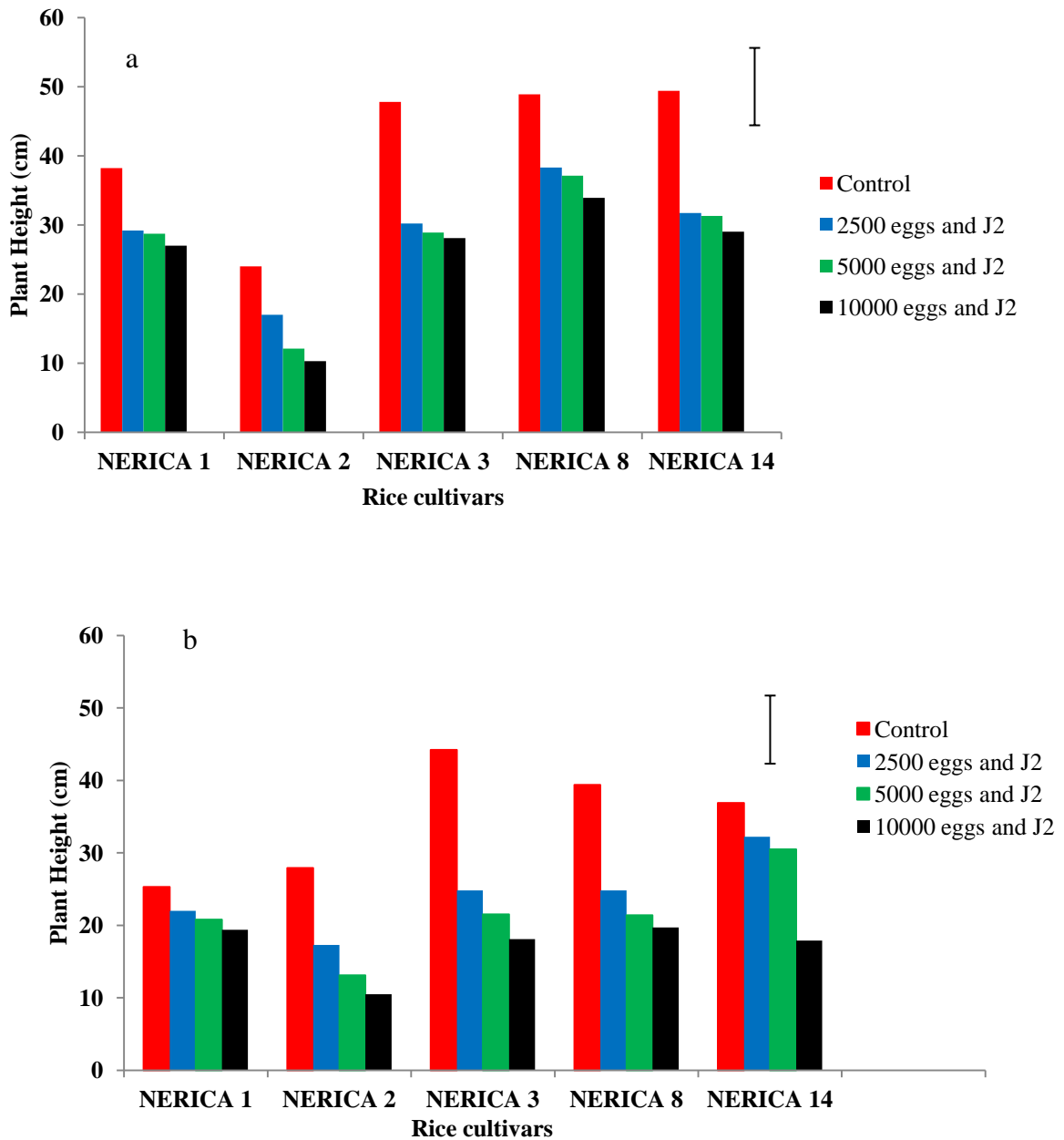

**Fig. 4.4: Effect of *Heterodera sacchari* population densities on height of five NERICA rice cultivars at 11 weeks after planting. a = first trial, b = second trial.**

LSD bar is for comparing treatment means across cultivars, J2 = second-stage juveniles.

NERICA rice plants responded differently to various nematode densities for mean number of leaves produced in the two trials (Figs 4.5a and 4.5b). The mean number of leaves produced by the inoculated NERICA rice plants were significantly ( $P \leq 0.05$ ) lower than the number of leaves produced by the uninoculated plants except NERICA 3 rice where there was no significant differences ( $P \leq 0.05$ ) between the plants inoculated with 2,500 and 5,000 eggs /J<sub>2</sub> and control in the first trial (Fig 4.5a). However, with increase in inoculum density, mean number of leaves produced reduced in all NERICA rice cultivars in the two trials (Figs. 4.5a and 4.5b).

There were significant differences ( $P \leq 0.05$ ) between the inoculated and uninoculated plants across all cultivars of NERICA rice for leaf chlorophyll content at eleven weeks after inoculation in the first and second trials, respectively. However, the plants inoculated with 2,500 and 5,000 eggs/J<sub>2</sub> in NERICA 8 were not significantly different from uninoculated NERICA 8 rice plants (Fig. 4.6a). NERICA 8 plants inoculated with 10,000 eggs /J<sub>2</sub> of *H. sacchari*, was significantly reduced ( $P \leq 0.05$ ) in leaf chlorophyll content than the control (Fig. 4.6a). Similarly, leaf chlorophyll content decreased rapidly with increasing inoculum density at eleven weeks after inoculation across NERICA rice cultivars in both trials (Figs. 4.6a and 4.6b).

The number of tillers produced by inoculated NERICA rice cultivars was significantly lowest ( $P \leq 0.05$ ) in NERICA 1, NERICA 2, NERICA 3, and NERICA 8 inoculated with 10,000 eggs / J<sub>2</sub> when compared with the control and inoculation levels of 2,500 and 5,000 eggs / J<sub>2</sub> (Fig. 4.7a). There were no significant differences between NERICA 3 and NERICA 8 rice cultivars inoculated with 2,500 eggs / J<sub>2</sub> for number of tillers produced and the control (Fig. 4.7a). In the second trial, the number of tillers produced by inoculated NERICA 1 and NERICA 2 were not significantly different ( $P \leq 0.05$ ) from the uninoculated NERICA 1 and NERICA 2 plants. The control of NERICA 1 and 2 did not produce any tiller (0.0 tillers). However, the tillers produced by the inoculated plants were chlorotic and also had poor growth (Fig. 4.7b). The mean number of tillers decreased with increasing nematode inoculum densities in both trials.

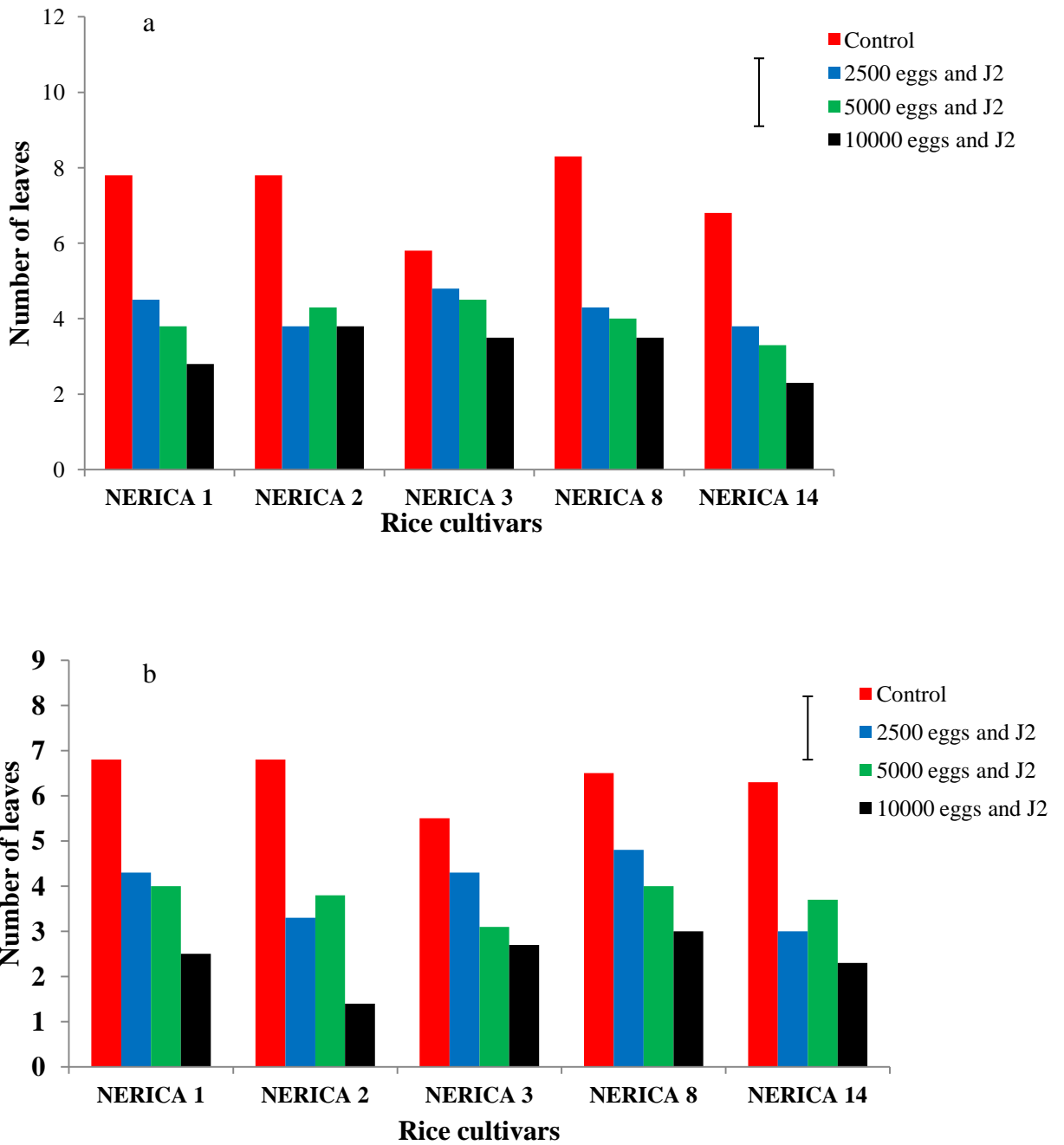

**Fig. 4.5: Effects of *Heterodera sacchari* population densities on leaf production of five NERICA rice cultivars at 11 weeks after inoculation. a = first trial, b = second trial.**

LSD bar is for comparing treatment means across cultivars, J<sub>2</sub> = second-stage juveniles.



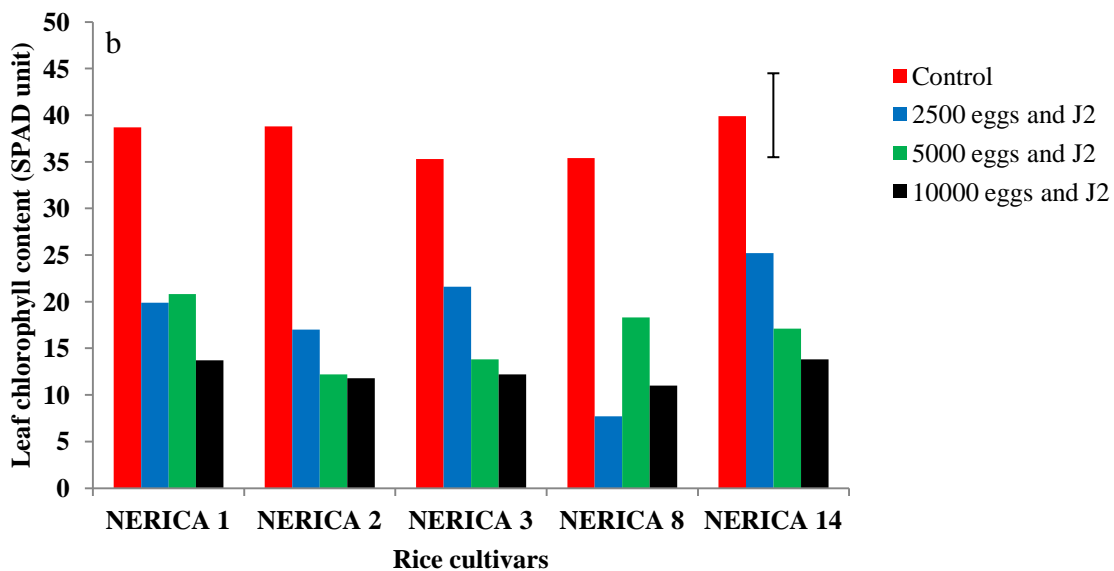
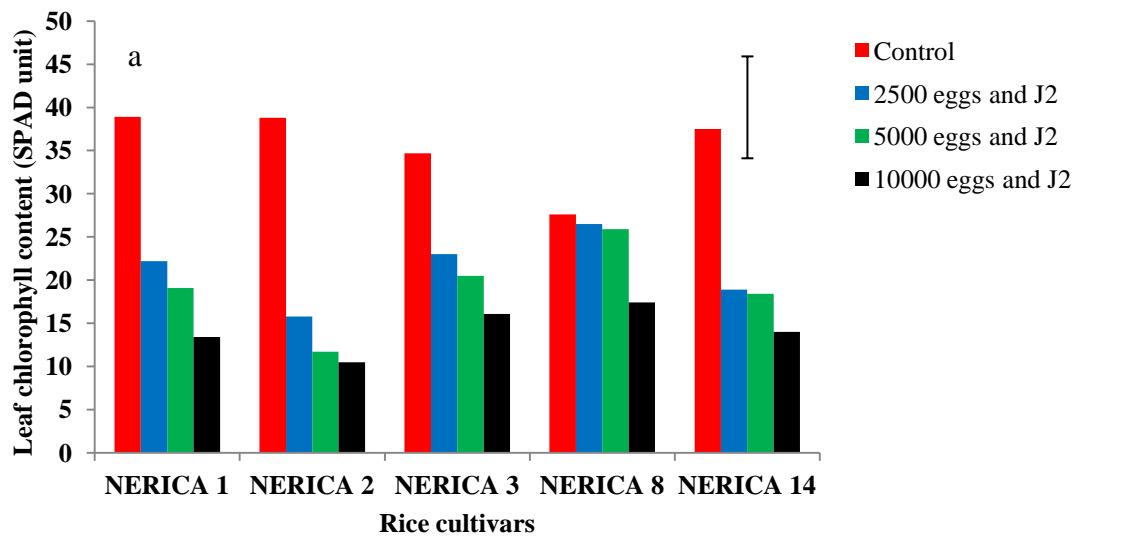

**Fig. 4.6: Effects of *Heterodera sacchari* population densities on leaf chlorophyll content of five NERICA rice cultivars at 11 weeks after inoculation. a = first trial, b = second trial.**

LSD bar is for comparing treatment means across cultivars, J<sub>2</sub> = second-stage juveniles.

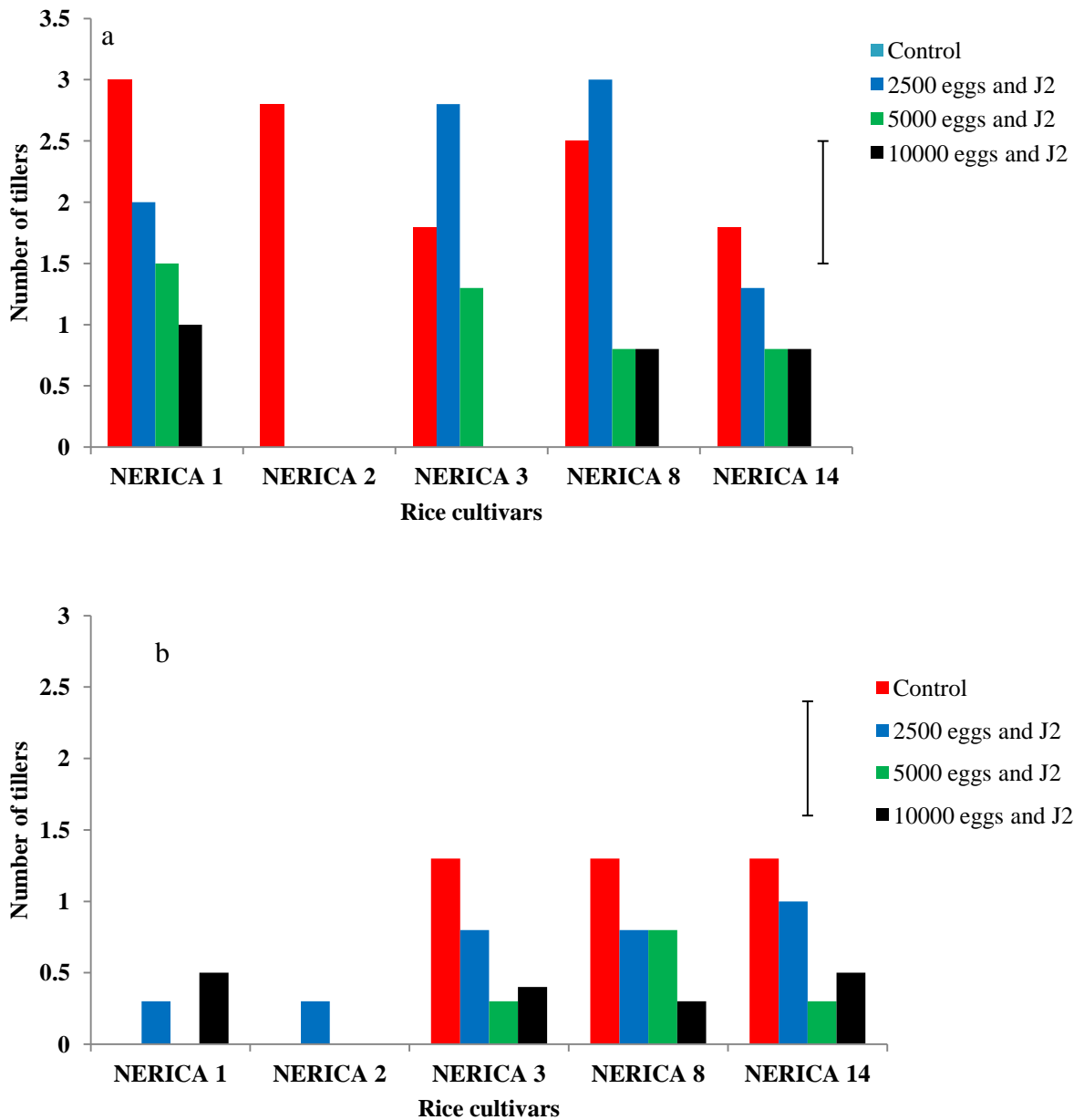

**Fig. 4.7: Effects of *Heterodera sacchari* population densities on number of tillers of five NERICA rice cultivars at 11 weeks after inoculation. a = first trial, b = second trial.**

LSD bar is for comparing treatment means across cultivars, J<sub>2</sub> = second-stage juveniles.

Fresh shoot weight was significantly lower ( $P \leq 0.05$ ) in the inoculated NERICA rice cultivars compared with the uninoculated plants except in NERICA 3 rice cultivar inoculated with 2,500 and 5,000 eggs/J<sub>2</sub> in the first trial (Fig. 4.8a). In the second trial, all the inoculated rice cultivars had significantly lower ( $P \leq 0.05$ ) fresh shoot weight than the control (Fig. 4.8b). Shoot weight decreased with increase in nematode population densities in both trials (Figs. 4.8a and 4.8b). NERICA 2 rice inoculated with 10,000 eggs/J<sub>2</sub> of *H. sacchari* had the lowest dry shoot weight of 0.4 g which was significantly lower than the uninoculated NERICA rice cultivars and the plants inoculated at 2,500, 5,000 and 10,000 eggs/J<sub>2</sub> of NERICA 1, NERICA 3, NERICA 8 and NERICA 14, respectively (Fig. 4.9a). In the second trial, the dry shoot weights of inoculated NERICA rice plants were significantly reduced ( $P \leq 0.05$ ) than the uninoculated plants across all NERICA rice cultivars (Fig. 4.9b). Generally, the dry shoot weights reduced with increase in inoculation density in the two trials.

The fresh root weights of rice plants inoculated with 2,500, 5,000 and 10,000 eggs/J<sub>2</sub> of *H. sacchari* were significantly lower ( $P \leq 0.05$ ) than the uninoculated NERICA rice cultivars in the two trials (Fig. 4.10a and 4.10b). In general, the root mass of NERICA rice decreased with increasing nematode inoculation densities in the two trials (Plate 4.1) The dry root weight obtained from the inoculated NERICA rice cultivars were significantly different ( $P \leq 0.05$ ) from the uninoculated rice plants in the two trials (Fig. 4.11a and 4.11b). The lowest dry root was observed in NERICA rice cultivars inoculated with 10,000 eggs/J<sub>2</sub> of *H. sacchari* in the two trials.

The NERICA rice cultivars did not differ significantly ( $P \leq 0.05$ ) in the length of time taken to produce flowers. However, there was delayed flowering in inoculated rice plants when compared with the uninoculated NERICA rice cultivars (Fig. 4.12a). The infected NERICA 2 did not flower at all inoculation densities (Fig. 4.12a). NERICA 14 infected with 10,000 eggs of *H. sacchari* took 85.5 days before flowering when compared with control that took 65.3 days to flowering (Fig. 4.12a). In the second trial, there were no significant differences between the uninoculated NERICA rice plants and plants inoculated with 2,500 nematodes however, plants inoculated with 5,000 and 10,000 nematodes produced flowers later than the uninoculated plants (Fig. 4.12b).

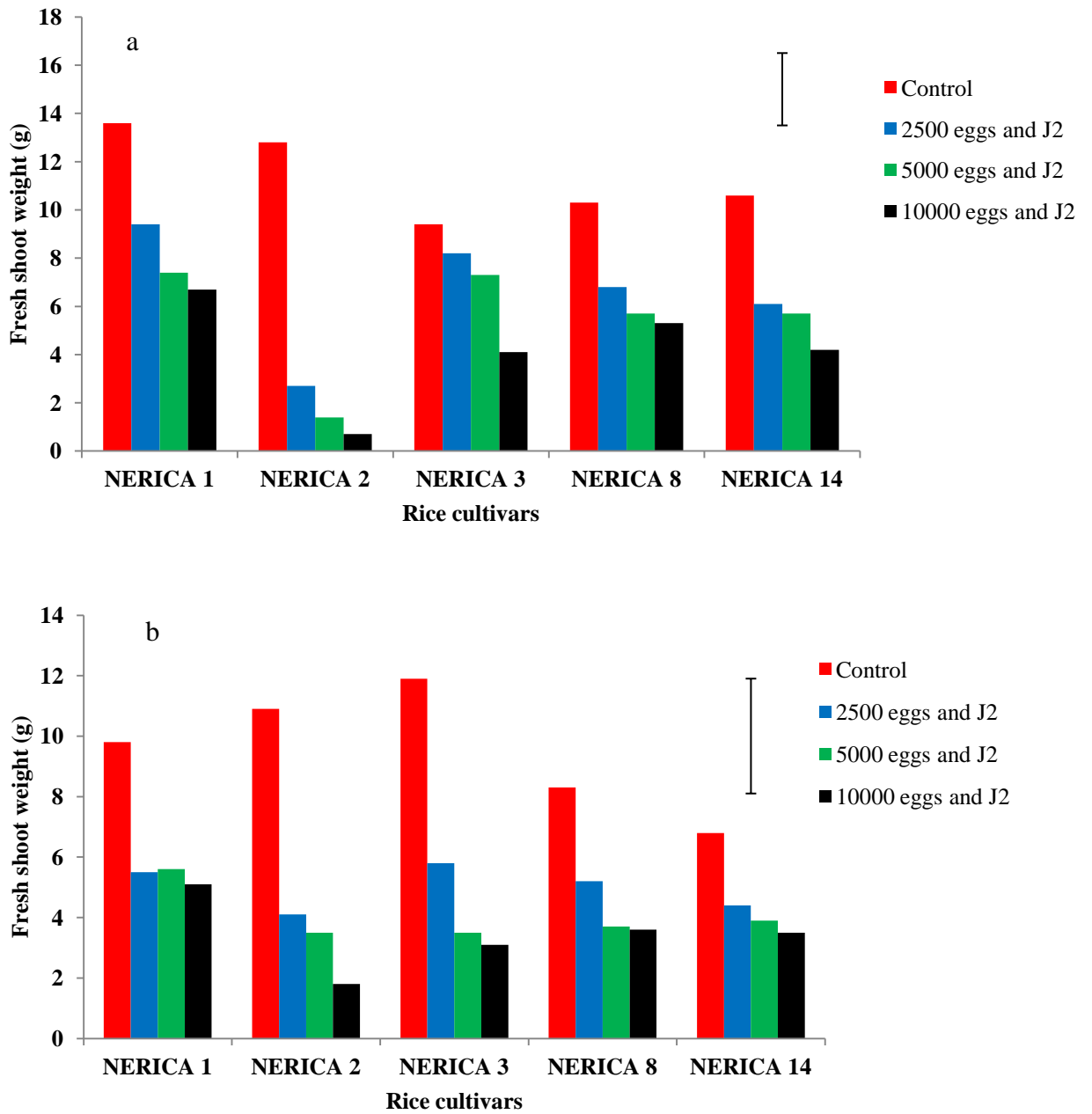

**Fig. 4.8: Effects of *Heterodera sacchari* population densities on fresh shoot weight of five NERICA rice cultivars at 11 weeks after inoculation. a = first trial, b = second trial.**

LSD bar is for comparing treatment means across cultivars, J<sub>2</sub> = second-stage juveniles.

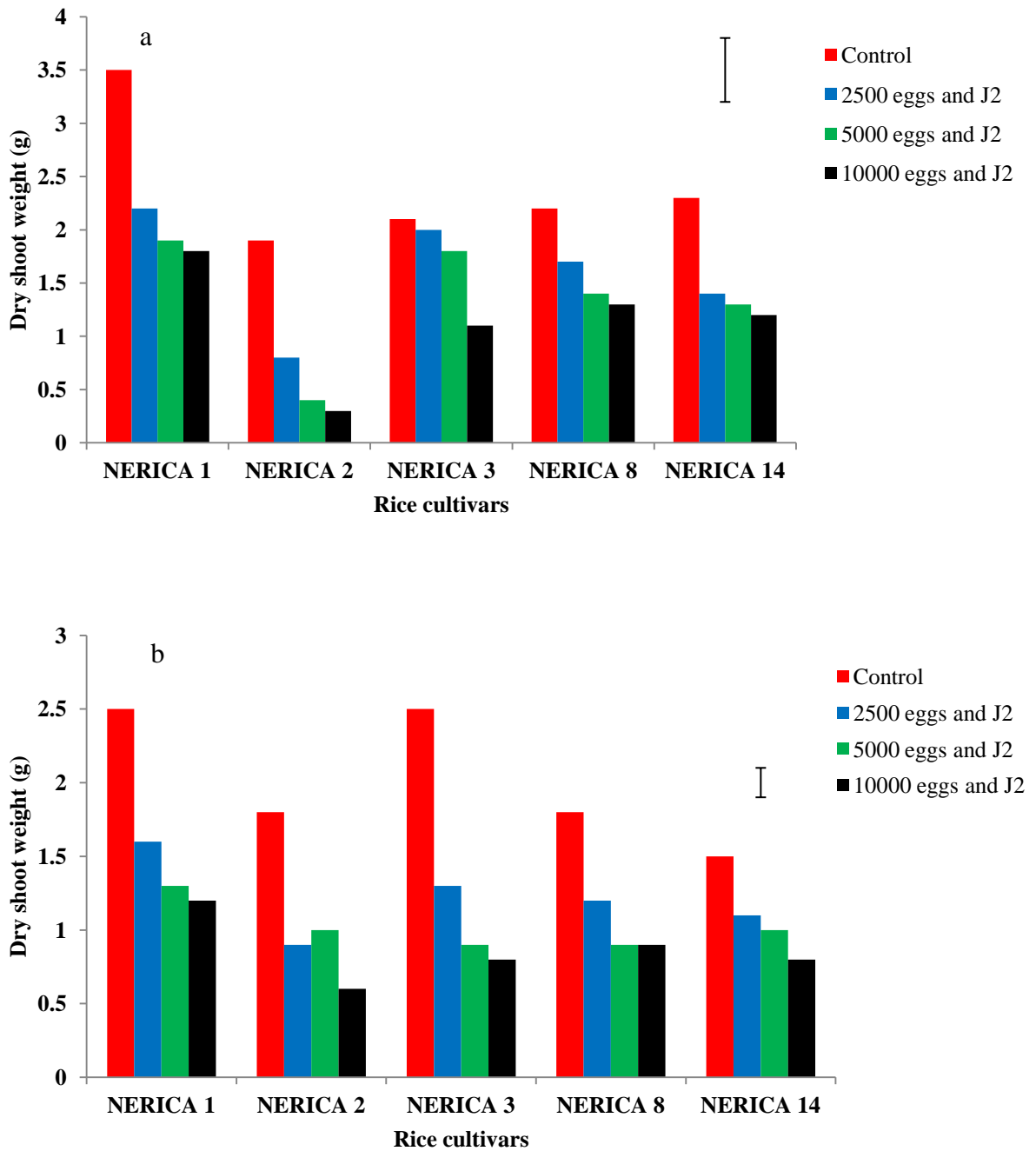

**Fig. 4.9: Effects of *Heterodera sacchari* population densities on dry shoot weight of five NERICA rice cultivars at 11 weeks after inoculation. a = first trial, b = second trial.**

LSD bar is for comparing treatment means across cultivars. J<sub>2</sub> = second-stage juveniles.

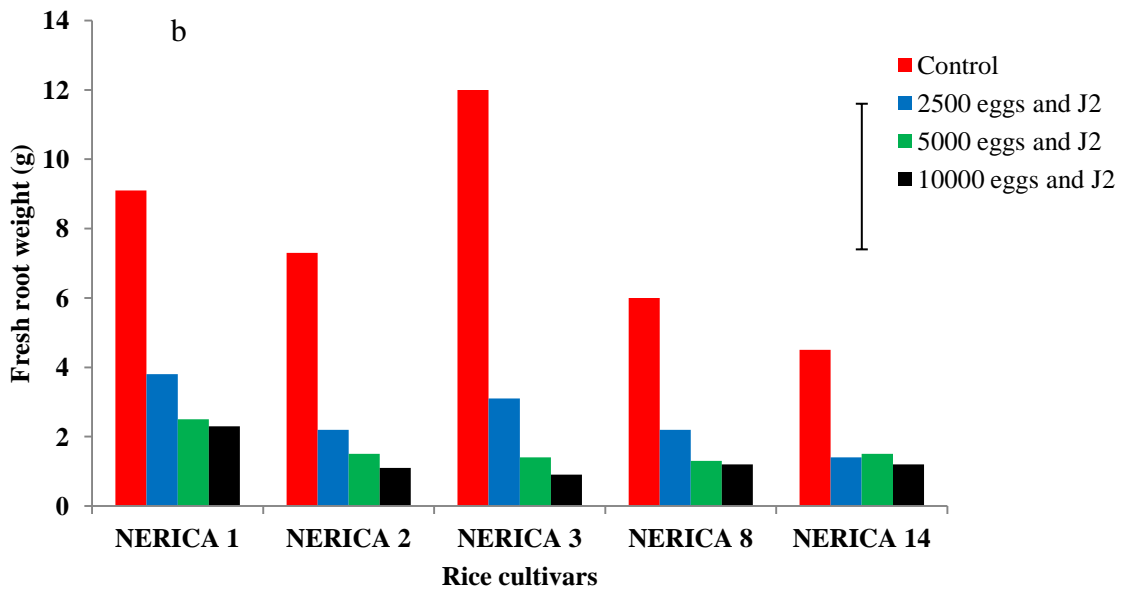
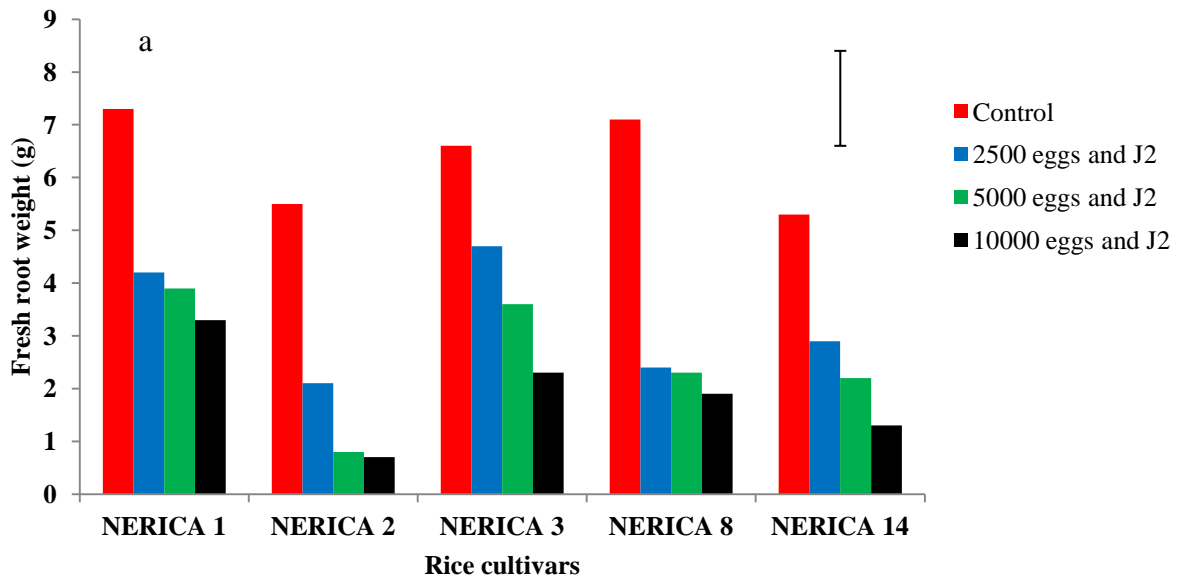

**Fig. 4.10: Effects of *Heterodera sacchari* population densities on fresh root weight of five NERICA rice cultivars at 11 weeks after inoculation. a = first trial, b = second trial.**

LSD bar is for comparing treatment means across cultivars, J<sub>2</sub> = second-stage juveniles.



**Plate 4.1: Effect of different inoculum densities of *Heterodera sacchari* on root development of NERICA rice at 11 weeks after inoculation.**

Where; A = Control, B = 2,500 eggs and second-stage juveniles of *H. sacchari*, C = 5000 eggs and J<sub>2</sub> of *H. sacchari* and D = 10000 eggs and J<sub>2</sub> of *H. sacchari*. J<sub>2</sub> = second-stage juveniles

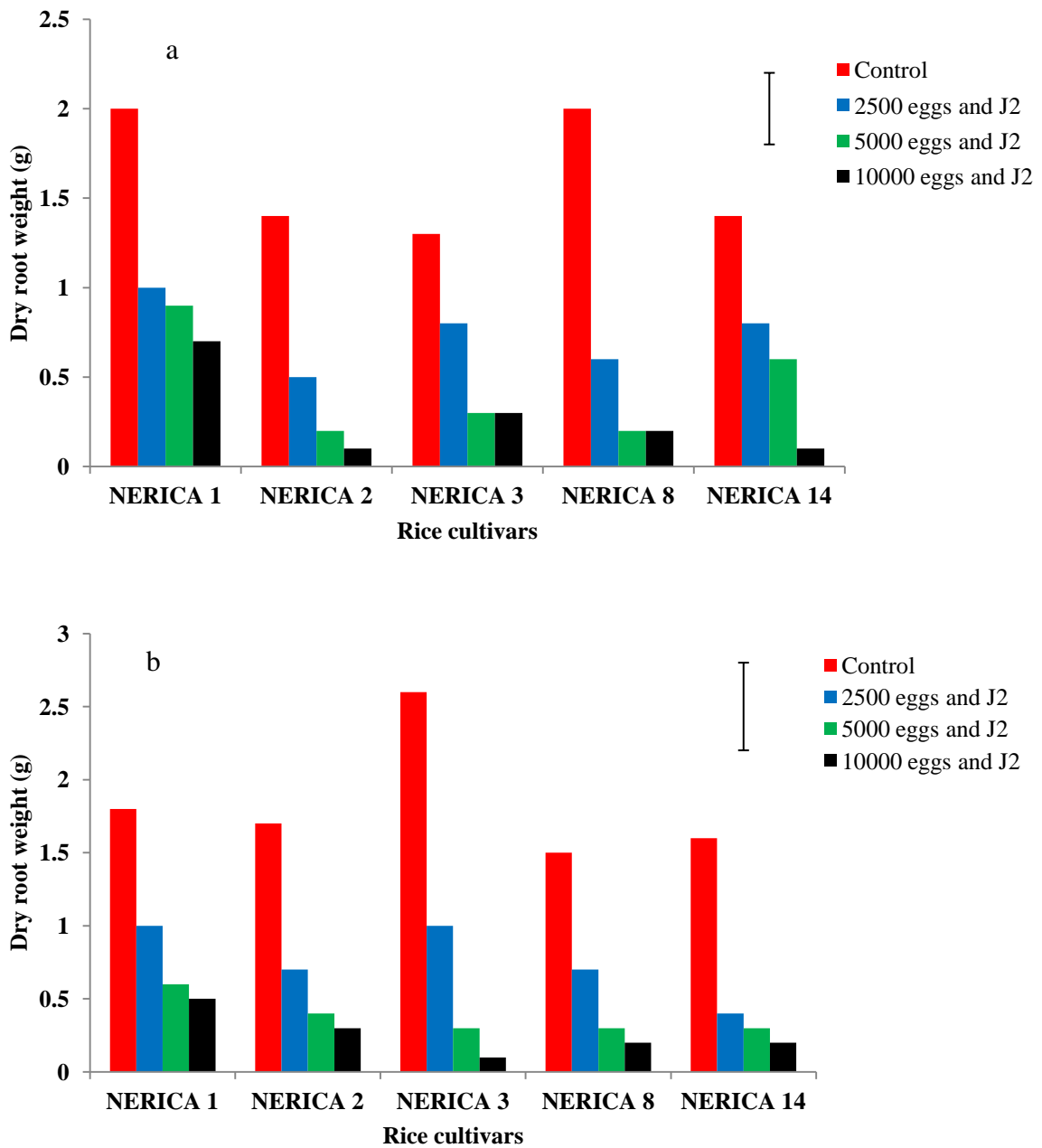

**Fig. 4.11: Effects of *Heterodera sacchari* population densities on dry root weight of five NERICA rice cultivars at 11 weeks after inoculation. a = first trial, b = second trial.**

LSD bar is for comparing treatment means across cultivars, J<sub>2</sub> = second-stage juveniles.



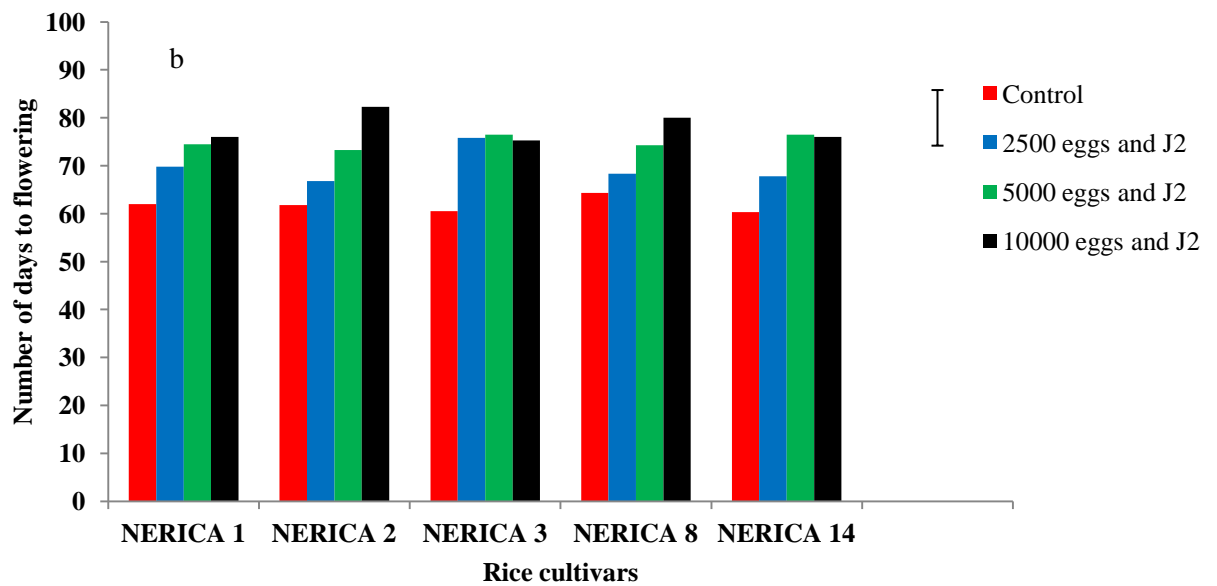
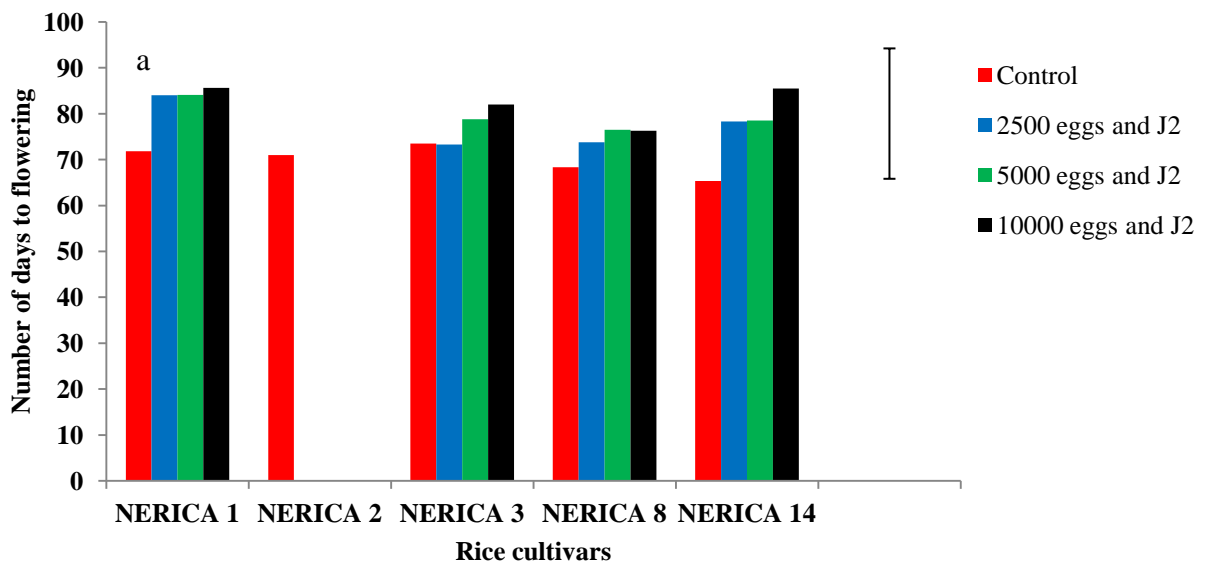

**Fig. 4.12: Effects of *Heterodera sacchari* population densities on number of days to flower of five NERICA rice cultivars at 11 weeks after inoculation. a = first trial, b = second trial**

LSD bar is for comparing treatment means across cultivars, J<sub>2</sub> = second-stage juveniles.

Generally, days to flowering increased with increasing nematode inoculum density in the two trials (Fig. 4.12a and 4.12b).

The total seed weight (yield) and weight of 50 seeds were the highest ( $P \leq 0.05$ ) in the uninfected NERICA rice cultivars when compared with the infected NERICA rice plants inoculated with eggs / juveniles of *H. sacchari* in the two trials (Figs 4.13a and b). The total seed (yield) weight of uninoculated NERICA rice had seed weights of 1.7 g (NERICA 8) followed by NERICA 2 (1.4 g), NERICA 14 (1.4 g), NERICA 3 (1.2 g) and NERICA 1 (1.0 g), respectively (Fig. 4.13a). In the second trial, uninfected NERICA 2 had the highest total seed weight (1.9 g) which was closely followed by uninfected NERICA 14 (1.7 g) (Fig. 4.14b). Furthermore, significantly lower ( $P \leq 0.05$ ) weights were obtained for 50 seeds of plants infected with nematodes in both trials (Fig. 4.14a and Fig. 4.14b). In general, with increasing inoculum density, there was reduction in total seed weight and weight of 50 seeds in the two trials.

The root damage score obtained for the infected NERICA rice plants were significantly higher ( $P \leq 0.05$ ) than values obtained from the uninfected plants across all cultivars at various inoculum densities in the two trials (Fig. 4.15a and Fig. 4.15b). However, the highest root damage score was 5.0 obtained from NERICA 8 and NERICA 14 infected with 10,000 eggs /J<sub>2</sub> of *H. sacchari*, respectively) whereas the least root damage was 2.3 (NERICA 3) in the inoculated plants (Fig. 4.15a). With increasing inoculation density, root damage also increased in the two trials (Figs 4.15a and 4.15b).

#### **4.2.3: Reproduction of *Heterodera sacchari* at different population densities on five NERICA rice cultivars**

The cyst production rating was significantly higher ( $P \leq 0.05$ ) in the inoculated plants across all cultivars when compared with the uninoculated plants in the two trials (Tables 4.3 and 4.4). NERICA 8 inoculated at 2,500 eggs had the least cyst production rating and was significantly different ( $P \leq 0.05$ ) from the control (Table 4.3). The total second -stage juveniles (J<sub>2</sub>) in root and soil were significantly higher ( $P \leq 0.05$ ) in inoculated plants than the uninoculated NERICA rice plants (Table 4.3).

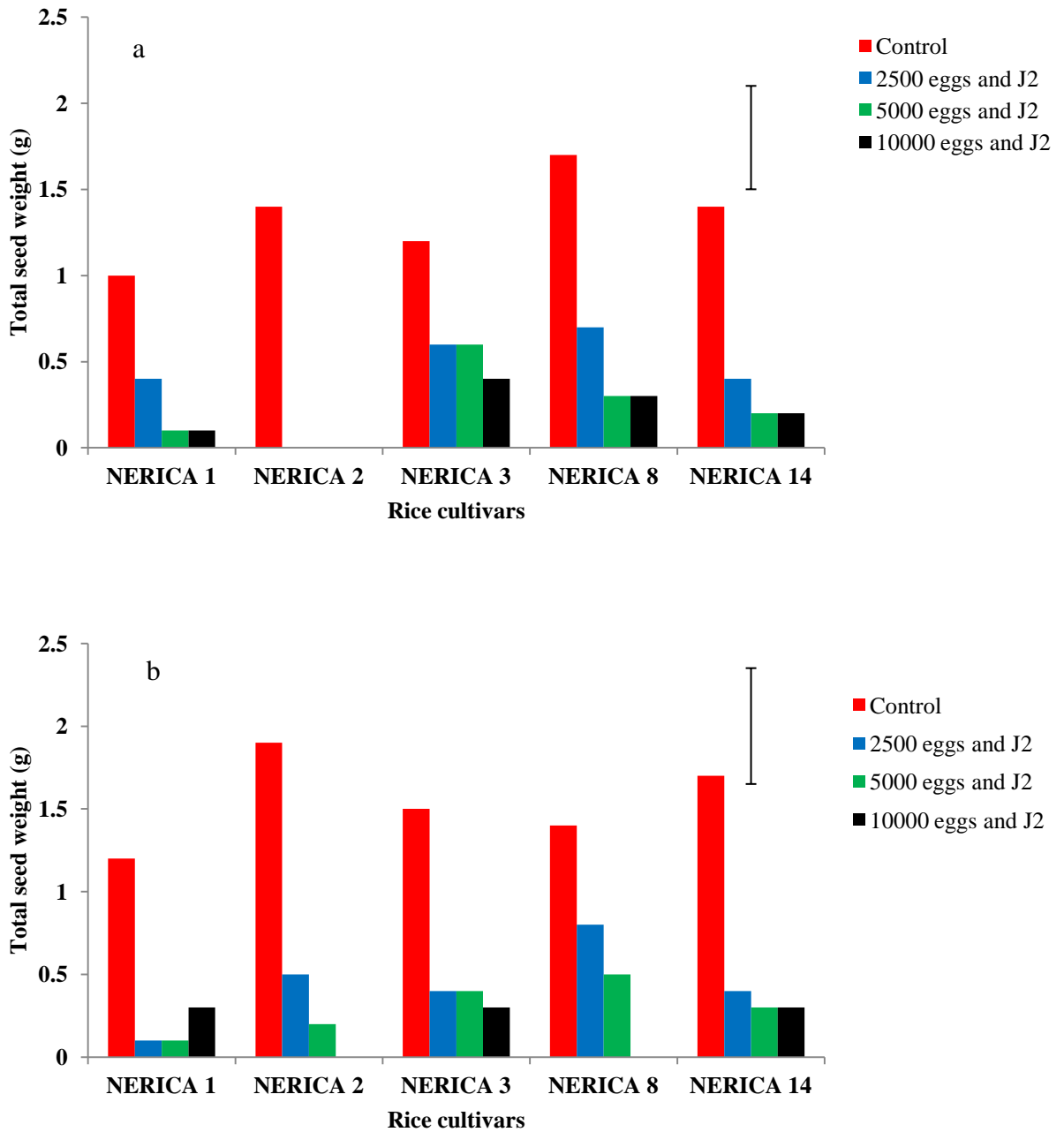

**Fig. 4.13: Effects of *Heterodera sacchari* population densities on total seed weight of five NERICA rice cultivars at 11 weeks after inoculation. a = first trial, b = second trial**

LSD bar is for comparing treatment means across cultivars. J<sub>2</sub> = second-stage juveniles.

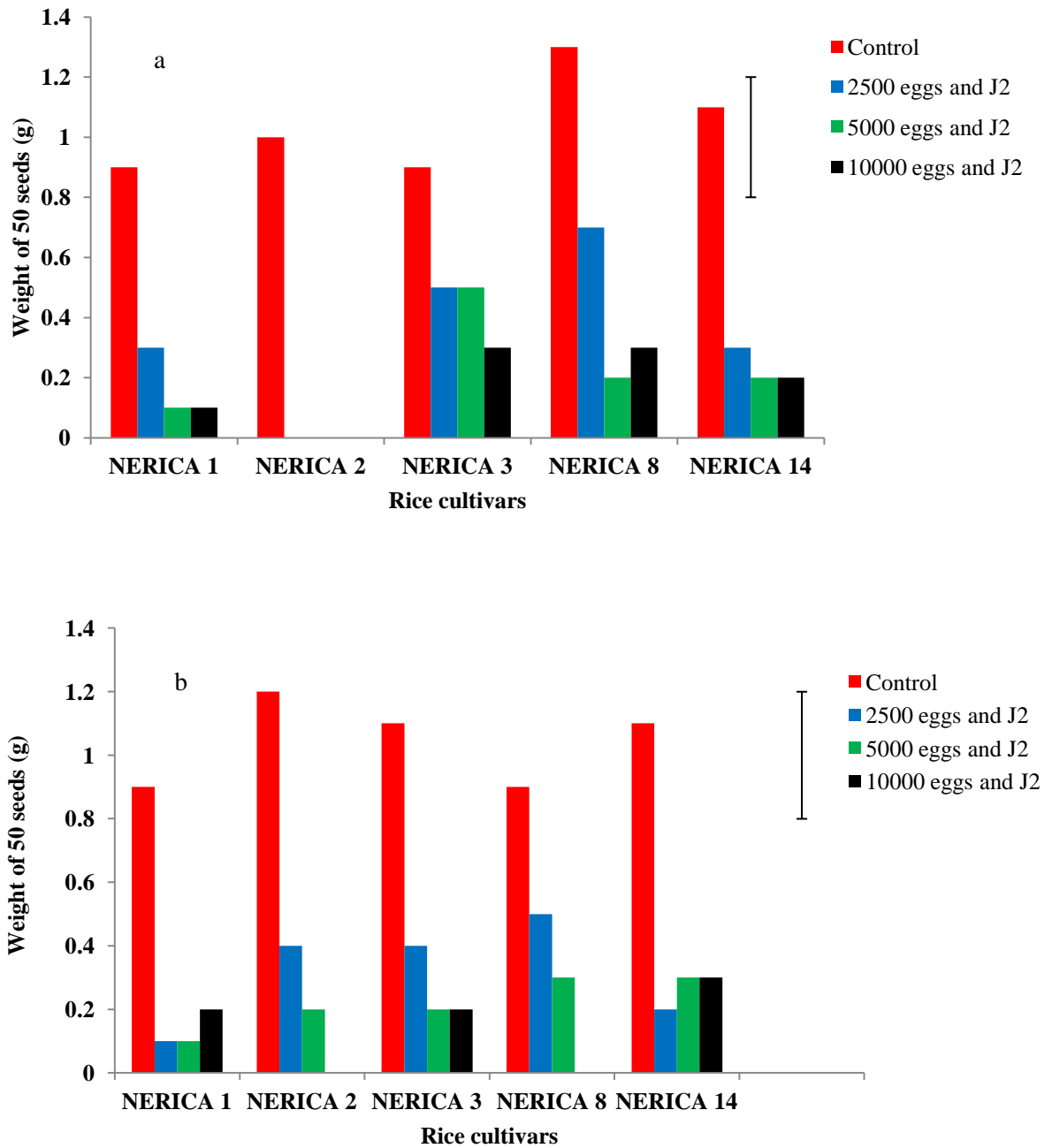

**Fig. 4.14: Effects of *Heterodera sacchari* population densities on weight of 50 seeds of five NERICA rice cultivars at 11 weeks after inoculation. a = first trial, b = second trial.**

LSD bar is for comparing treatment means across cultivars, J<sub>2</sub> = second-stage juveniles.

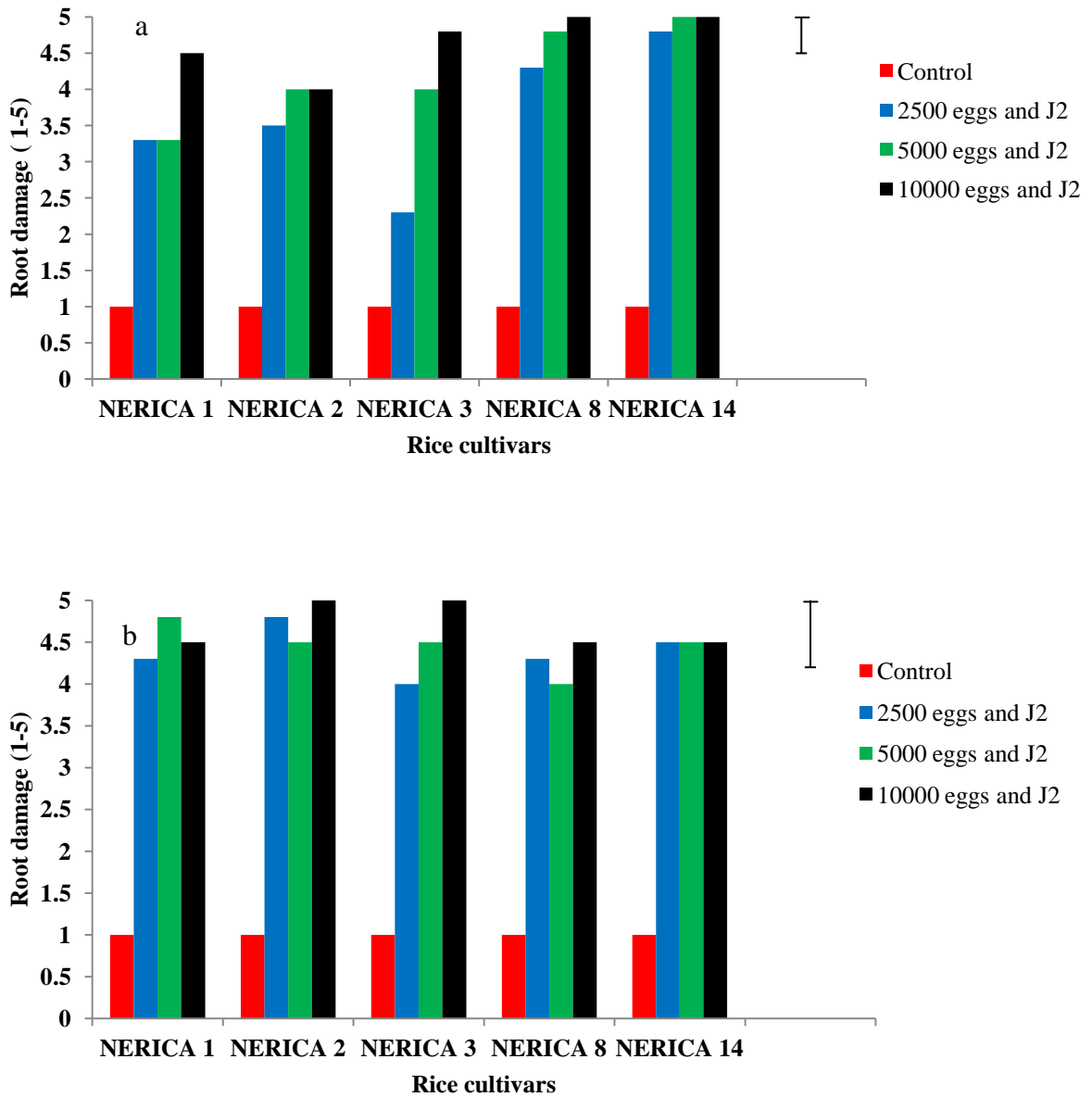

**Fig. 4.15: Effects of *Heterodera sacchari* population densities on root damage of five NERICA rice cultivars at 11 weeks after inoculation. a = first trial, b = second trial**

LSD bar is for comparing treatment means across cultivars, J<sub>2</sub> = second-stage juveniles. Root damage (1-5) where; 1= clean, 2= (1-10% slight damage), 3= (11-30% mild damage), 4= (31-50% moderate root damage) and 5= (>51% severe root damage)

**Table 4.3: Reproduction of *Heterodera sacchari* at different population densities on five NERICA rice cultivars (first trial)**

Cultivar	Treatment (Pi)	Cyst Production rating (0-4)	Total J <sub>2</sub> in pot (root + soil)	Total Cysts in Pot (root + soil)	Number of eggs / J <sub>2</sub> per cyst	Final nematode population in pot (Pf)	Reproductive Factor (RF)
NERICA 1	Control (0)	0.0	0.0	0.0	0.0	0.0	0.0
	2500 eggs & J <sub>2</sub>	3.3	12450.0	7809.3	287.8	2259966.5	903.9
	5000 eggs & J <sub>2</sub>	3.8	17670.0	8656.5	286.5	2497757.3	499.6
	10000 eggs & J <sub>2</sub>	4.0	27215.0	13241.3	308.0	4105535.4	410.6
NERICA 2	Control (0)	0.0	0.0	0.0	0.0	0.0	0.0
	2500 eggs & J <sub>2</sub>	4.0	22725.0	3215.0	235.0	778250	311.3
	5000 eggs & J <sub>2</sub>	4.0	29075.0	3997.5	218.0	900530	180.1
	10000 eggs & J <sub>2</sub>	4.0	35925.0	4840.0	248.8	1240117	124.0
NERICA 3	Control (0)	0.0	0.0	0.0	0.0	0.0	0.0
	2500 eggs & J <sub>2</sub>	2.8	7605.0	4621.5	318.5	1479552.8	591.8
	5000 eggs & J <sub>2</sub>	4.0	9825.0	4867.5	268.8	1318209	263.6
	10000 eggs & J <sub>2</sub>	4.0	10765.0	6772.8	253.5	1727669.8	172.8
NERICA 8	Control (0)	0.0	0.0	0.0	0.0	0.0	0.0
	2500 eggs & J <sub>2</sub>	2.3	11860.0	3799.8	118.5	462136.3	184.9
	5000 eggs & J <sub>2</sub>	3.8	21755.0	3836.8	141.8	565813.24	113.2
	10000 eggs & J <sub>2</sub>	4.0	23115.0	4928.8	132.3	675195.24	67.5
NERICA 14	Control (0)	0.0	0.0	0.0	0.0	0.0	0.0
	2500 eggs & J <sub>2</sub>	4.0	7650.0	7469.3	275.3	2063948.3	825.6
	5000 eggs & J <sub>2</sub>	4.0	18032.5	7655.0	207.0	1602617.5	320.5
	10000 eggs & J <sub>2</sub>	4.0	9285.0	13638.3	235.5	3221104.7	322.1
LSD (P≤0.05)		0.7	14274.0	5359.1	88.3	487482.53	286.8

LSD for comparing treatment means within the same column, cyst production rating: 0 = no cyst (Resistant); 1 = 1-2 cysts (Moderately Resistant); 2 = 3-10 cysts (Moderately Susceptible); 3 = 11-30 cysts (Susceptible); 4 = 31 cysts and above (Highly susceptible). J<sub>2</sub> = second-stage juvenile, Reproductive Factor (RF) = Pf/Pi; where Pf = final nematode population, Pi = initial nematode population

**Table 4.4: Reproduction of *Heterodera sacchari* at different population densities on five NERICA rice cultivars (second trial)**

Cultivar	Treatment (Pi)	Cyst Production rating (0-4)	Total J <sub>2</sub> in pot (root +soil)	Total Cysts in Pot (root + soil)	Number of eggs and J <sub>2</sub> per cyst	Final nematode population in pot (Pf)	Reproductive Factor (RF)
NERICA 1	Control (0)	0.0	0.0	0.0	0.0	0.0	0.0
	2500 eggs & J <sub>2</sub>	2.8	27225.0	32470.0	220.3	7180366.0	2872.2
	5000 eggs & J <sub>2</sub>	3.8	25200.0	37315.0	240.0	8980800.0	1796.2
	10000 eggs & J <sub>2</sub>	4.0	35700.0	37493.0	205.5	7740511.5	774.1
NERICA 2	Control (0)	0.0	0.0	0.0	0.0	0.0	0.0
	2500 eggs & J <sub>2</sub>	3.3	19613.0	31825.0	246.3	7858110.5	3143.2
	5000 eggs & J <sub>2</sub>	3.8	22113.0	38278.0	252.3	9679652.4	1935.9
	10000 eggs & J <sub>2</sub>	4.0	30688.0	34986.0	317.8	11149239.0	1114.9
NERICA 3	Control (0)	0.0	0.0	0.0	0.0	0.0	0.0
	2500 eggs & J <sub>2</sub>	3.0	27450.0	23662.0	185.5	4416751.0	1766.7
	5000 eggs & J <sub>2</sub>	3.5	13825.0	18610.0	207.5	3875400.0	775.1
	10000 eggs & J <sub>2</sub>	4.0	29750.0	29238.0	233.5	6856823.0	685.7
NERICA 8	Control (0)	0.0	0.0	0.0	0.0	0.0	0.0
	2500 eggs & J <sub>2</sub>	3.8	8325.0	26238.0	224.8	5906627.4	2362.7
	5000 eggs & J <sub>2</sub>	4.0	13675.0	33968.0	197.8	6732545.4	1346.5
	10000 eggs & J <sub>2</sub>	4.0	13625.0	32998.0	220.5	7289684.0	728.9
NERICA 14	Control (0)	0.0	0.0	0.0	0.0	0.0	0.0
	2500 eggs & J <sub>2</sub>	4.0	11800.0	33938.0	191.5	6510927.0	2604.4
	5000 eggs & J <sub>2</sub>	4.0	26725.0	20143.0	222.0	4498471.0	899.7
	10000 eggs & J <sub>2</sub>	4.0	32400.0	29618.0	251.8	8704550.4	870.5
LSD (P≤0.05)		0.7	19415.0	18727.0	98.2	1858406.4	123.9

LSD for comparing treatment means within the same column, cyst production rating: 0 = no cyst (Resistant); 1 = 1-2 cysts (Moderately Resistant); 2 = 3-10 cysts (Moderately Susceptible); 3= 11-30 cysts (Susceptible); 4 = 31 cysts and above (Highly susceptible). J<sub>2</sub> = second-stage juvenile, Reproductive Factor (RF) = Pf/Pi; where Pf = final nematode population, Pi = initial nematode population.

NERICA 2 rice inoculated with 10,000 eggs/second-stage juveniles ( $J_2$ ), had the highest number of  $J_2$  population in pot (35,925.0  $J_2$ ), closely followed by NERICA 2 plants inoculated with 5,000 eggs / $J_2$  (29,075.0  $J_2$ ) and the lowest came from NERICA 3 (7,605.0  $J_2$ ) (Table 4.3).

The total  $J_2$  populations in pots of plants inoculated with 5,000 and 10,000 eggs/juveniles were significantly higher ( $P \leq 0.05$ ) than in pots of plants inoculated at the density of 2,500 eggs/ $J_2$  and the uninoculated plants (Table 4.3).

Total cyst population in pots of infected NERICA 1 and NERICA 14 plants were significantly different ( $P \leq 0.05$ ) from the uninoculated rice plants (Table 4.3). There were no significant differences among the infected and the uninfected plants of NERICA 2, NERICA 3 and NERICA 8 (Table 4.3). The highest number of cysts in pot were recovered from NERICA 14 plants (13,638.3 cysts) followed by NERICA 1 (13,241.3 cysts) infected with 10,000 eggs and  $J_2$  of *H. sacchari* while the least total number of cysts was obtained from NERICA 2 plants (3,215.0 cysts) inoculated with 10,000 eggs/ $J_2$  (Table 4.3).

Total cyst in pot increased with increase in inoculum densities across all cultivars in in the two trials (Tables 4.3 and 4.4). Number of eggs and juveniles per cysts ranged from 118.5 nematodes to 318.5 nematodes in all infected plants across cultivars, and there were no significant differences among the plants infected with 2,500, 5,000 and 10,000 eggs/ $J_2$  across all the cultivars (Table 4.3).

The reproductive factors (RF) of inoculated plants were significantly different ( $P \leq 0.05$ ) from the uninoculated rice plants across all NERICA rice cultivars in both trials (Table 4.3). Furthermore, there were significant reductions in the RF of rice plants inoculated with 5,000 and 10,000 nematodes when compared with the plants inoculated at 2,500 eggs/ $J_2$  of *H. sacchari* in both trials (Tables 4.3 and 4.4).

In the second trial, there were significant differences ( $P \leq 0.05$ ) in the cyst production rating of NERICA 1 and NERICA 2 inoculated with 2,500 eggs/ $J_2$  of *H. sacchari* compared with inoculations in other NERICA rice cultivars and the control (Table 4.4). NERICA 1 rice cultivar had the highest  $J_2$  population in pots inoculated with 10,000 eggs/ $J_2$  which was significantly different ( $P \leq 0.05$ ) from the control (Table 4.4). The Total cysts in pot and the RF were significantly higher ( $P \leq 0.05$ ) in all inoculated NERICA rice



cultivars in the second trial than the first trial (Table 4.4). In general, there were significant reductions in the RF of rice plants inoculated with 5,000 and 10,000 nematodes when compared with the plants inoculated at 2,500 eggs and J<sub>2</sub> of *H. sacchari* in the two trials (Tables 4.3 and 4.4).

### **4.3: Pathogenicity of *Heterodera sacchari* on NERICA rice in the field**

#### **4.3.1: Effect of *Heterodera sacchari* on growth, yield and nematode reproduction across NERICA rice cultivars**

The mean plant height of NERICA rice plants at four weeks after sowing in the *H. sacchari*-infested field was significantly ( $P \leq 0.05$ ) reduced when compared with the mean values obtained from the control (denematized) field soils (Figs. 4.16a and 4.16b). This was the trend until the end of the experiment in the two trials. Similarly, the number of leaves produced and leaf chlorophyll content of rice plants on the nematode-infested field decreased significantly ( $P \leq 0.05$ ) at week four after planting when compared with rice plants grown on the control (denematized) field (Figs. 4.17 and 4.18), respectively. At week 12, number of leaves produced by rice plants on the nematode-infested field was 3.5 whereas in the control field, number of leaves produced was 4.0 (Fig. 4.17a).

The leaf chlorophyll content of NERICA rice plants at twelve weeks after planting was significantly lower ( $P \leq 0.05$ ) in plants grown in the nematode -infested field (30.9 chlorophyll content) while in the control field, leaf chlorophyll content was 41.8 chlorophyll content (Fig. 4.18). This same trend was observed in the second trial.

#### **4.3.2: Response of five NERICA rice cultivars to *Heterodera sacchari* infection in the field**

There were no significant differences ( $P \leq 0.05$ ) in plant height of NERICA 1 and NERICA 2 rice cultivars grown in the nematode-infested and in the control fields at 12 weeks after planting (WAP) in the two trials (Figs. 4.19a and 4.19b). However, the height of NERICA 1 and NERICA 2 rice grown in the nematode-infested field were shorter than those plants in the control field (Fig 4.19). Furthermore, NERICA 3, NERICA 8 and NERICA 14 rice planted in the nematode-infested field were significantly shorter ( $P \leq 0.05$ ) than those planted in the control field at twelve weeks after planting when the experiment

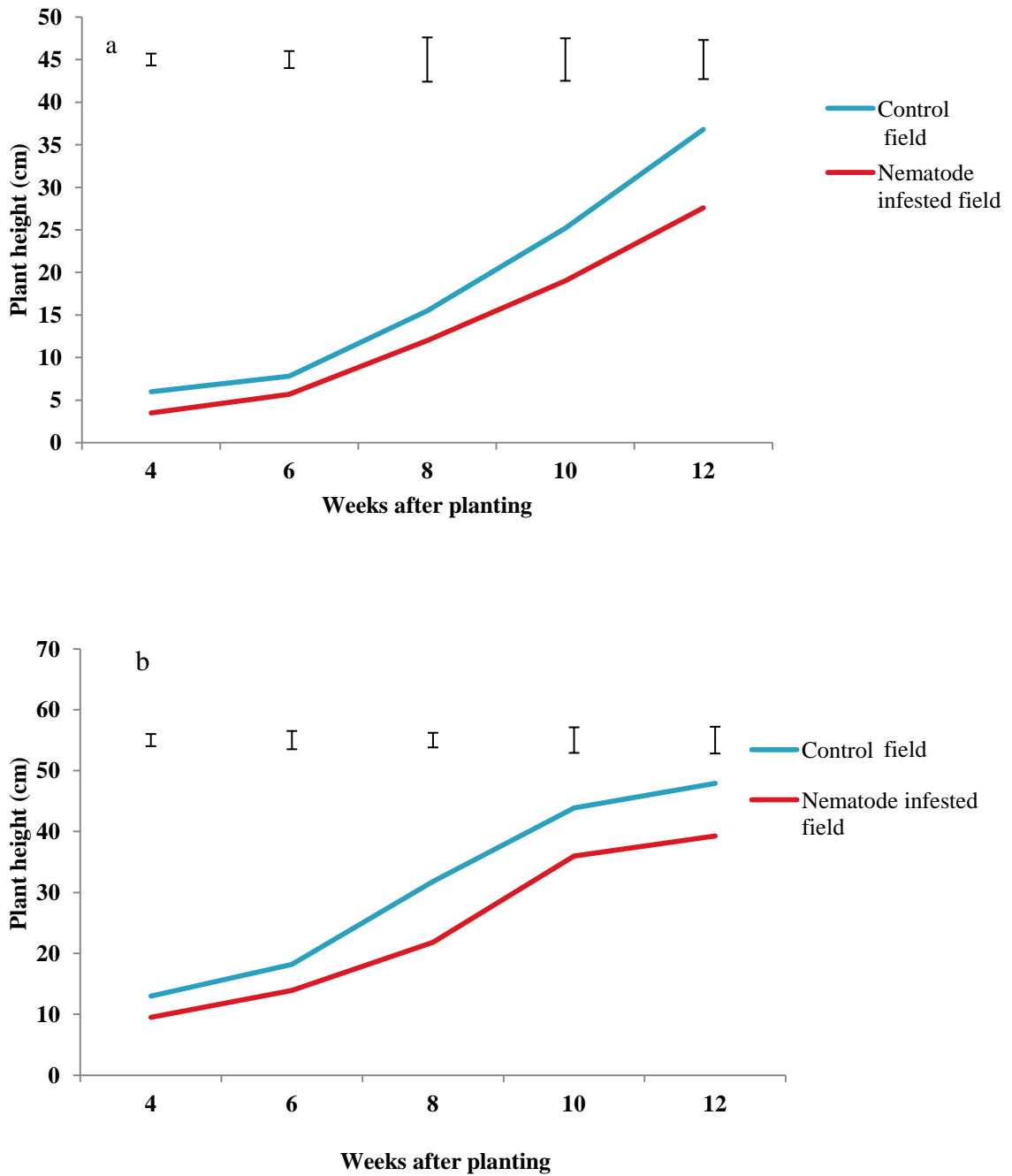

**Fig. 4.16: Effect of *Heterodera sacchari* on height of NERICA rice cultivars after planting. a = first trial, b = second trial.**

LSD bars are for comparing treatment means at each specific sampling time

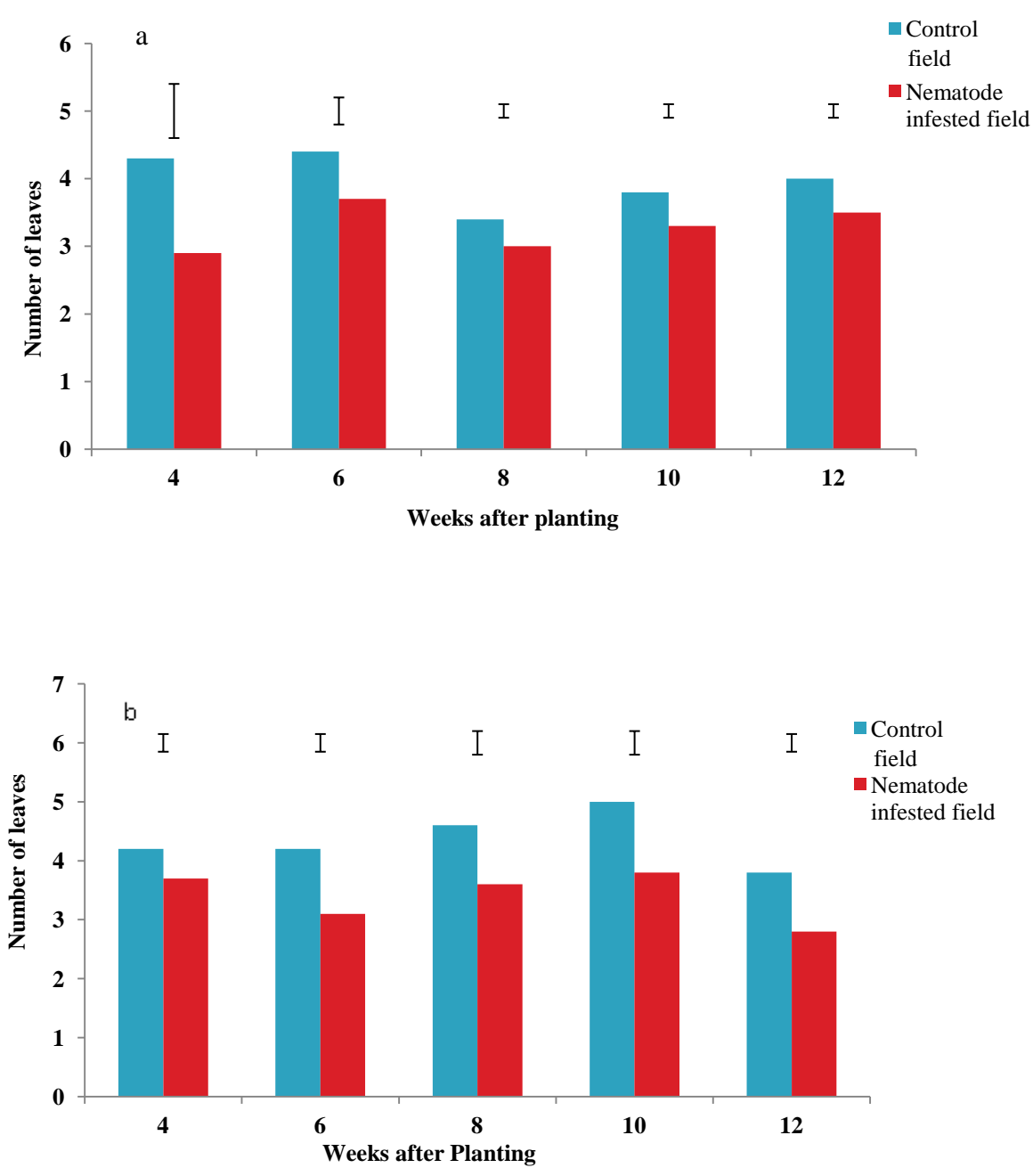

**Fig. 4.17: Effect of *Heterodera sacchari* on leaf production of NERICA rice cultivars weeks after planting. a = first trial, b = second trial.**

LSD bars are for comparing treatment means at each specific sampling time

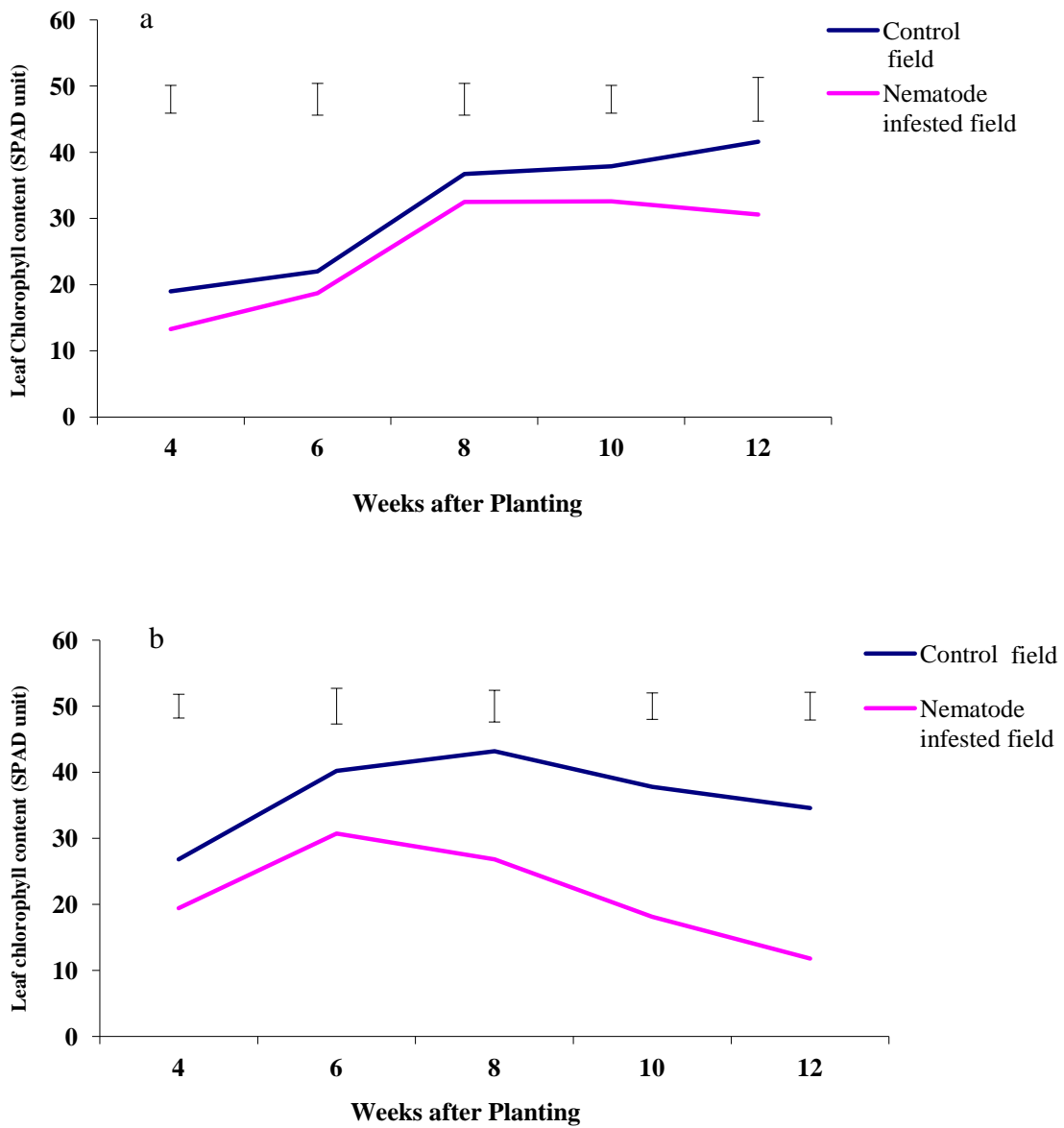

**Fig 4.18: Effect of *Heterodera sacchari* on leaf chlorophyll content of NERICA rice cultivars weeks after planting. a = first trial, b = second trial.**

LSD bars are for comparing treatment means at each specific sampling time

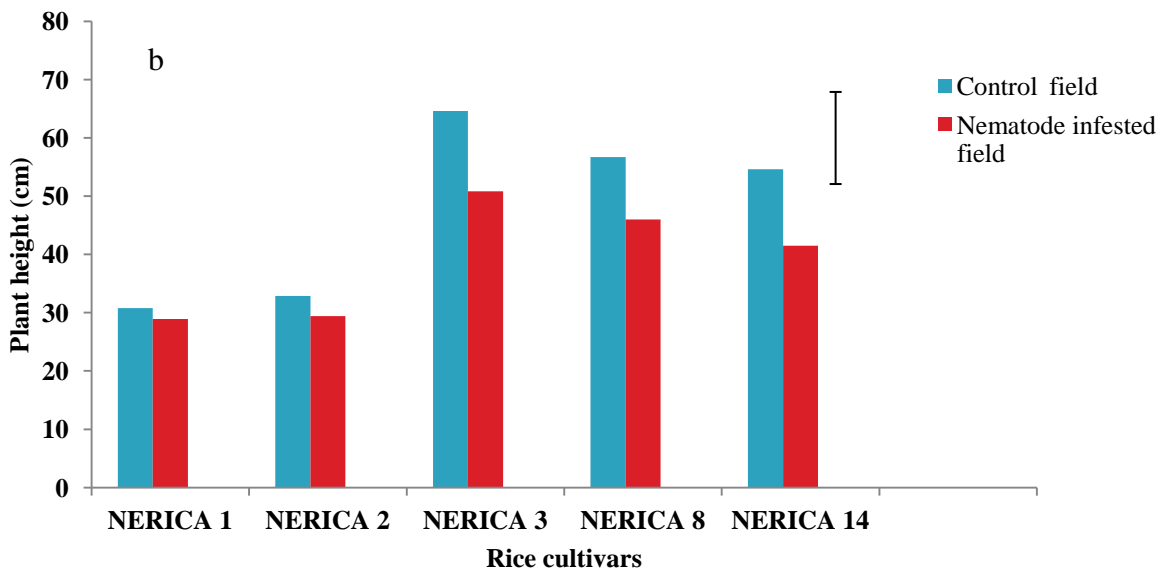
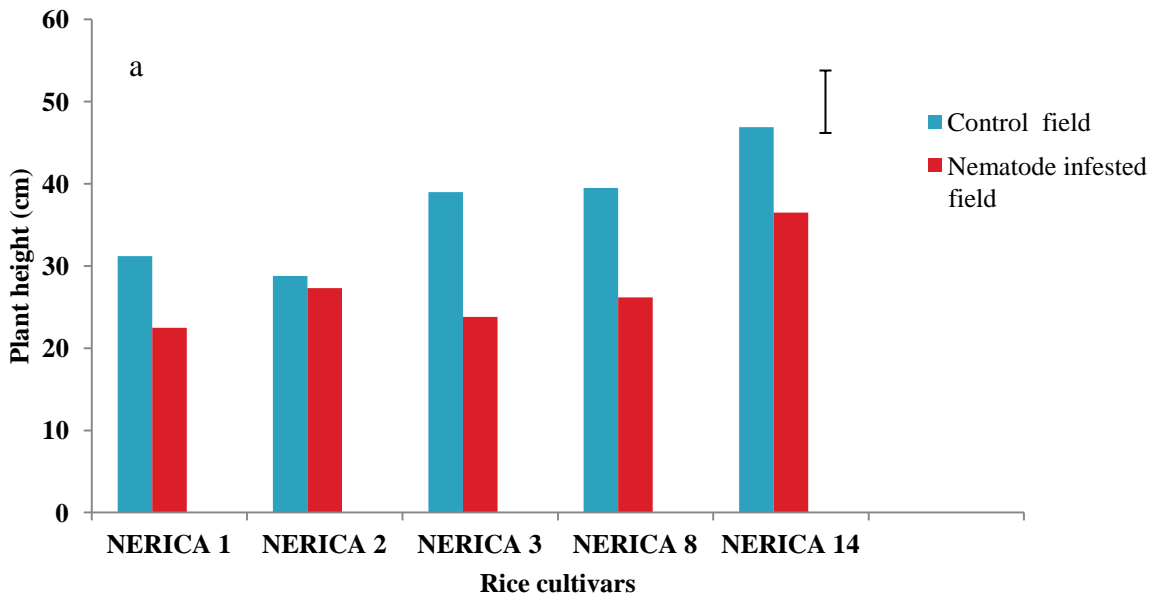

**Fig. 4.19: Effects of *Heterodera sacchari* on the height (cm) of five NERICA rice cultivars in the field at twelve weeks after planting. a = first trial, b = second trial**

LSD bar for comparing treatment means across cultivars.

was terminated (Fig. 4.19a). Generally, the height of NERICA rice cultivars grown in the nematode-infested field was shorter than those planted in the control field in the two trials.

The mean number of leaves produced by rice planted on control field was significantly higher ( $P \leq 0.05$ ) than those planted in the nematode-infested field across all cultivars except NERICA 14 where there was no significant difference between the plants from the control field and those planted on the nematode-infested field (Fig. 4.20a). In general terms, rice grown on the treated field produced more leaves than rice cultivars cultivated on the nematode-infested field in both trials.

The mean leaf chlorophyll content of NERICA rice cultivars planted in the control field was not significantly different ( $P \leq 0.05$ ) from those planted in the nematode-infested field (Fig. 4.21a). However, leaf chlorophyll was higher in rice plants grown in the control field than those grown in the nematode-infested field (Fig. 4.21a). In the second trial, leaf chlorophyll content of all the NERICA rice cultivars grown in the nematode-infested field were significantly reduced ( $P \leq 0.05$ ) than those planted in the control field (Fig. 4.21b). The highest leaf chlorophyll content was recorded on NERICA 14 (44.3) planted in the control field while the least was obtained for NERICA 8 (31.4) grown in the nematode-infested field at 12 WAP (Fig. 4.21a).

The mean number of tillers produced by NERICA rice cultivars grown in the nematode-infested field was reduced than those planted in the control field across the NERICA rice cultivars in both trials (Fig 4.22a and 4.22b). However, NERICA 1 cultivar planted on the control field had a significantly ( $P \leq 0.05$ ) higher number of tillers (8.3 tillers) than those planted in the nematode-infested soil (4.9 tillers) (Fig. 4.22a). In the second trial, NERICA cultivars planted on the nematode-infested field produced significantly ( $P \leq 0.05$ ) lower number of tillers than those planted in the control field (Fig. 4.22b).

Rice cultivars in the nematode-infested field had reduced fresh shoot weight than those grown in the control field in both trials. Fresh shoot weight of NERICA rice cultivars was reduced in nematode-infested field than in control field, however, there were no significant differences (Fig. 4.23a), In the second trial, fresh shoot weight of rice cultivars were significantly lower in the nematode-infested field than those cultivated in the control field except NERICA 1 (Fig. 4.23b).

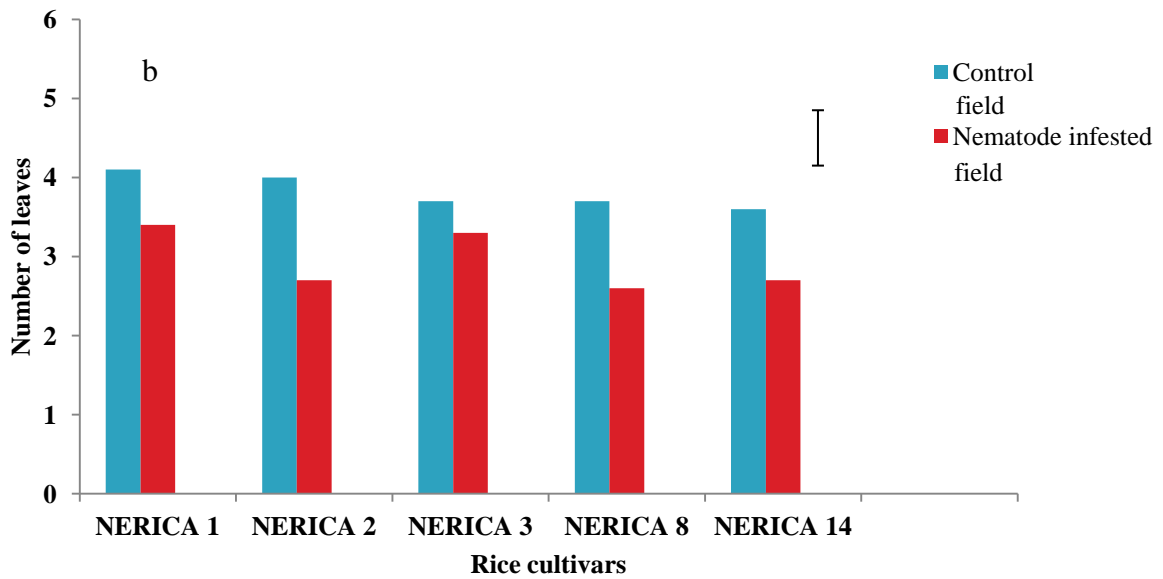
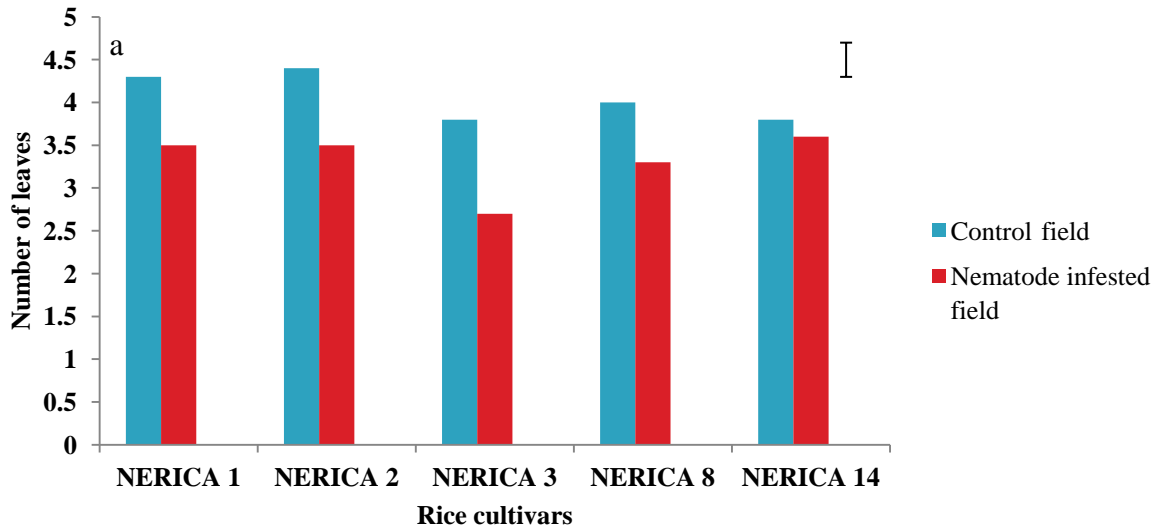

**Fig. 4.20: Effects of *Heterodera sacchari* on leaf production of five NERICA rice cultivars in the field at twelve weeks after planting. a = first trial, b = second trial.**

LSD bar for comparing treatment means across cultivars.

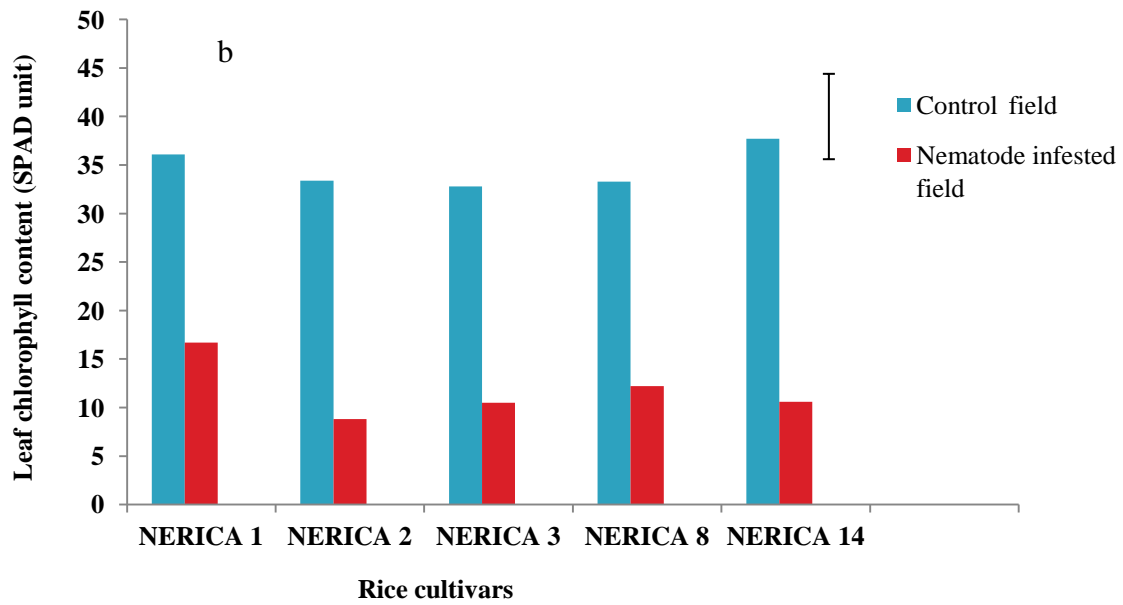
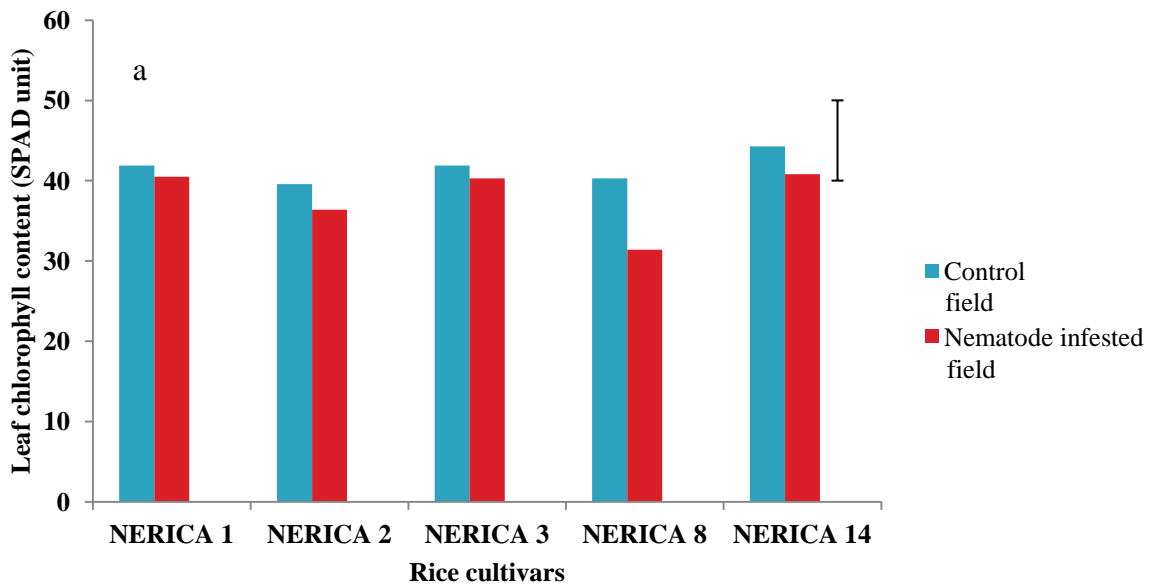

**Fig. 4.21: Effects of *Heterodera sacchari* on leaf chlorophyll content of five NERICA rice cultivars in the field at twelve weeks after planting. a = first trial, b = second trial.**

LSD bar for comparing treatment means across cultivars.



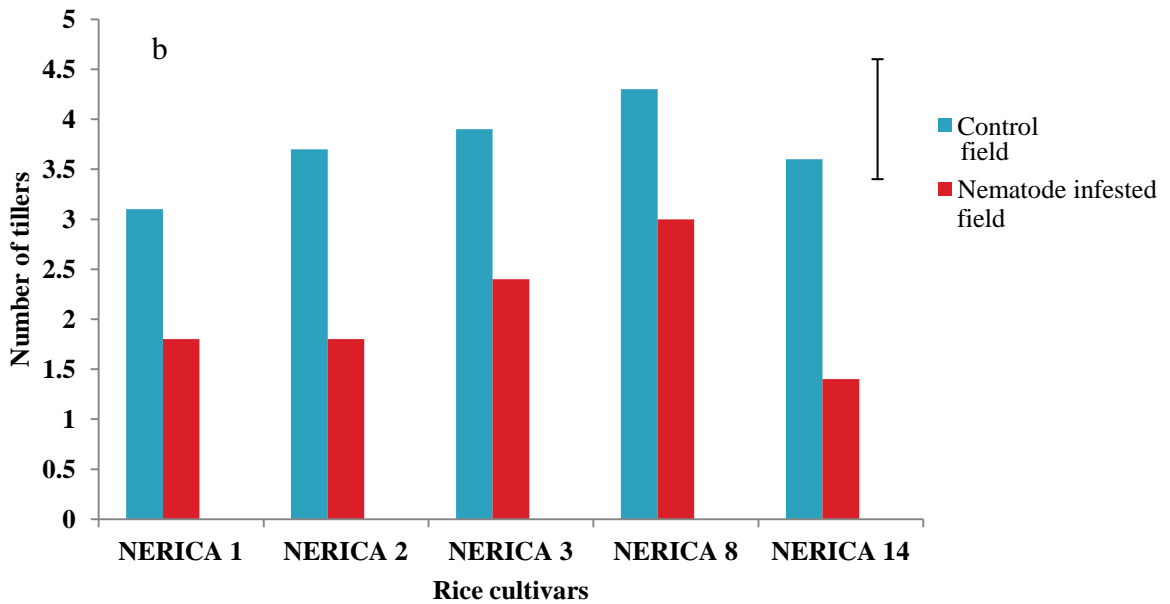
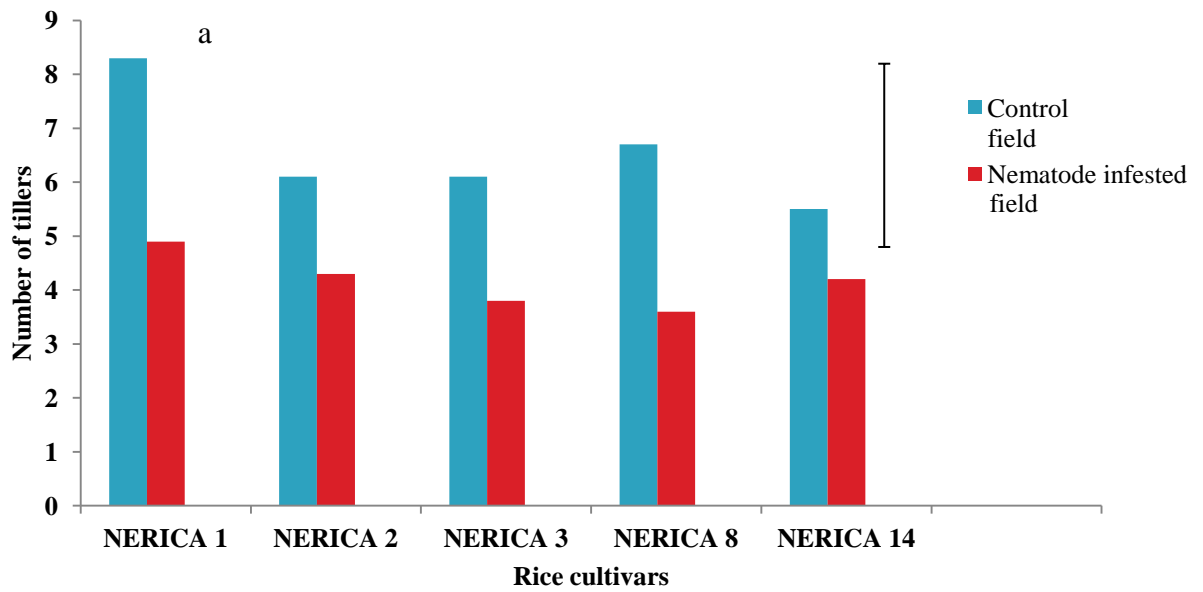

**Fig. 4.22: Effect of *Heterodera sacchari* on number of tillers of five NERICA rice cultivars in the field at twelve weeks after planting. a = first trial, b = second trial.**

LSD bar for comparing treatment means across cultivars.

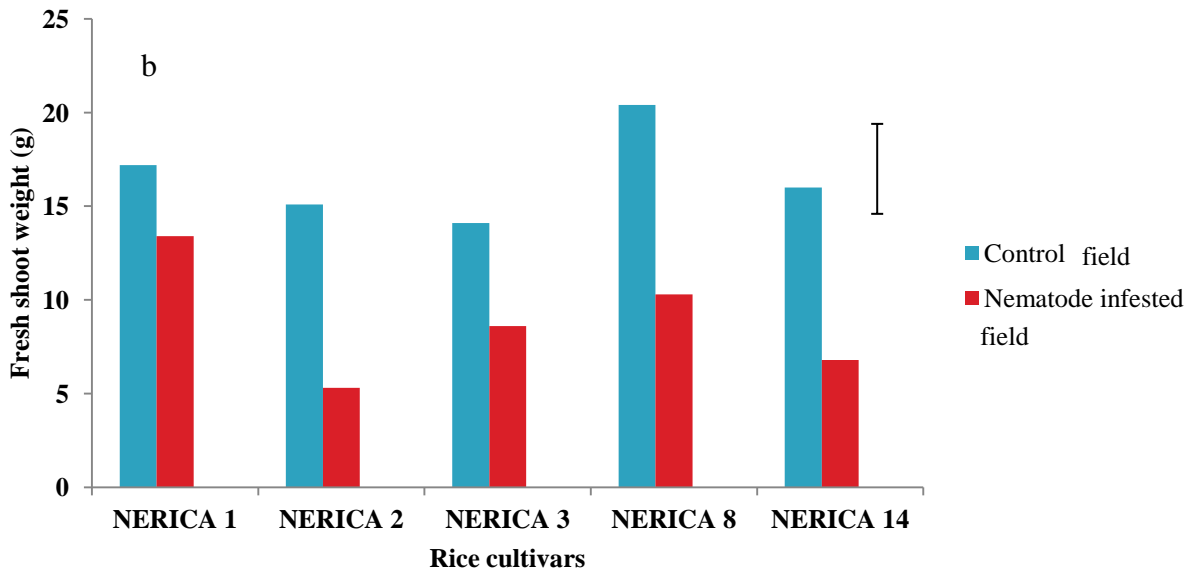
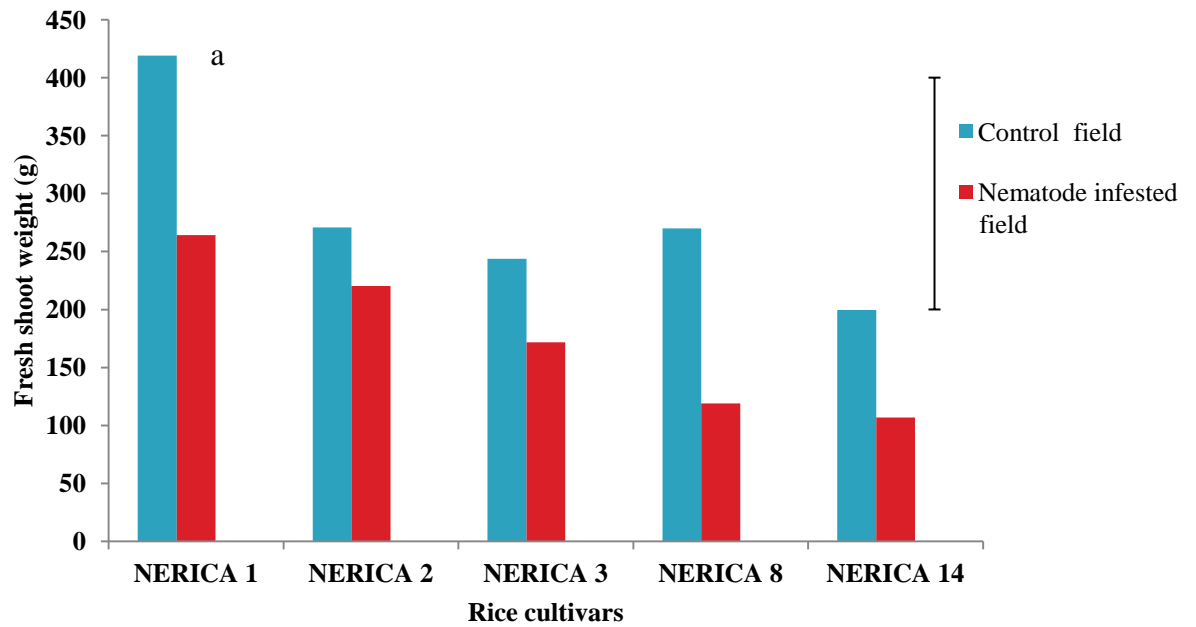

**Fig. 4.23: Effect of *Heterodera sacchari* on shoot weight of five NERICA rice cultivars in the field at twelve weeks after planting. a = first trial, b = second trial**

LSD bar for comparing treatment means across cultivars

Dry shoot weight was not significantly different ( $P \leq 0.05$ ) across all NERICA rice cultivars grown in both the nematode-infested and the control fields in the first trial (Fig. 4.24a). In the second trial, NERICA rice cultivars planted in the nematode-infested soil was significantly lower ( $P \leq 0.05$ ) in dry shoot weight than those grown in the control field (Fig. 4.24b). The fresh root weight was significantly ( $P \leq 0.05$ ) lower in rice cultivars planted in the nematode-infested field than those grown in the control field in the second trial (Fig. 4.25b). Rice cultivars grown in nematode-infested field produced fewer roots than those grown in the control field in both trials (Fig. 4.25a and 4.25b). Furthermore, the dry root weight of NERICA rice cultivars grown in the nematode-infested field was significantly lower ( $P \leq 0.05$ ) than those grown in control field in the two trials (Fig. 4.26).

The total seed weight produced by rice cultivars planted in the control field ranged from 4.5 g (NERICA 14) to 31.9 g (NERICA 1), which were not significantly better than rice plants grown in the nematode infested field (excluding NERICA 1). Furthermore, in the nematode-infested field, the total seed weight ranged from 1.8 g (NERICA 14) to 9.9 g (NERICA 3) (Fig. 4.27a). In the second trial, the total seed weight of NERICA rice cultivars grown in the nematode-infested field was significantly lower ( $P \leq 0.05$ ) than the seed weight of rice obtained from the control field (Fig. 4.27b).

The values obtained for total seed weight across NERICA rice cultivars grown in the control field were higher than those grown in the nematode-infested field in both trials (Figs. 4.27a and 4.27b). The weight of 100 seeds (grain fill) of rice cultivars planted in the nematode-infested field had significantly lower ( $P \leq 0.05$ ) weight than those planted in the control field in both trials (Fig. 4.28). Furthermore, 100 seeds weight of NERICA rice cultivars grown in the nematode-infested field had poor grain fill when compared with those plants planted in the control field. Total grain yield per hectare produced by NERICA rice cultivars planted in the nematode-infested field was lower than grain yield produced per hectare by plants grown in the control field in the two trials (Fig. 4.29). In the nematode-infested field however, total grain yield per hectare produced by NERICA 14 was the least (180.8 kg/ha), and NERICA 3 produced 984.8 kg/ha compared with NERICA 14 grown in the control field with grain yield of 453.5 kg/ha while the highest grain yield was produced by NERICA 1 (3189.5 kg/ha) in the control field (Fig. 4.29a).

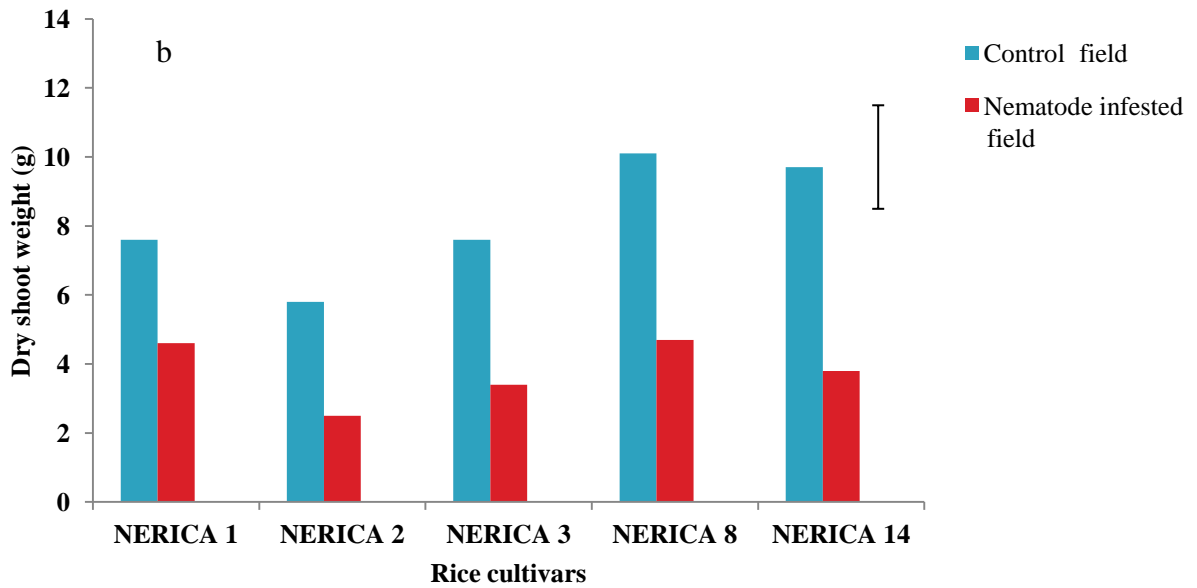
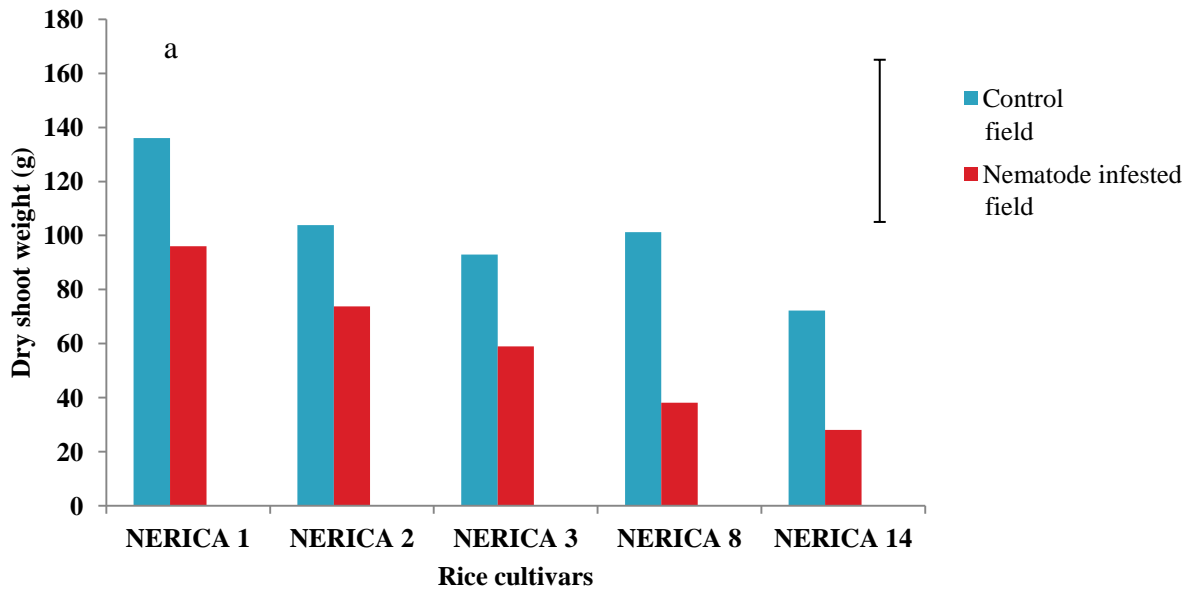

**Fig. 4.24: Effect of *Heterodera sacchari* on dry shoot weight of five NERICA rice cultivars in the field at twelve weeks after planting. a = first trial, b = second trial**

LSD bar for comparing treatment means across cultivars.

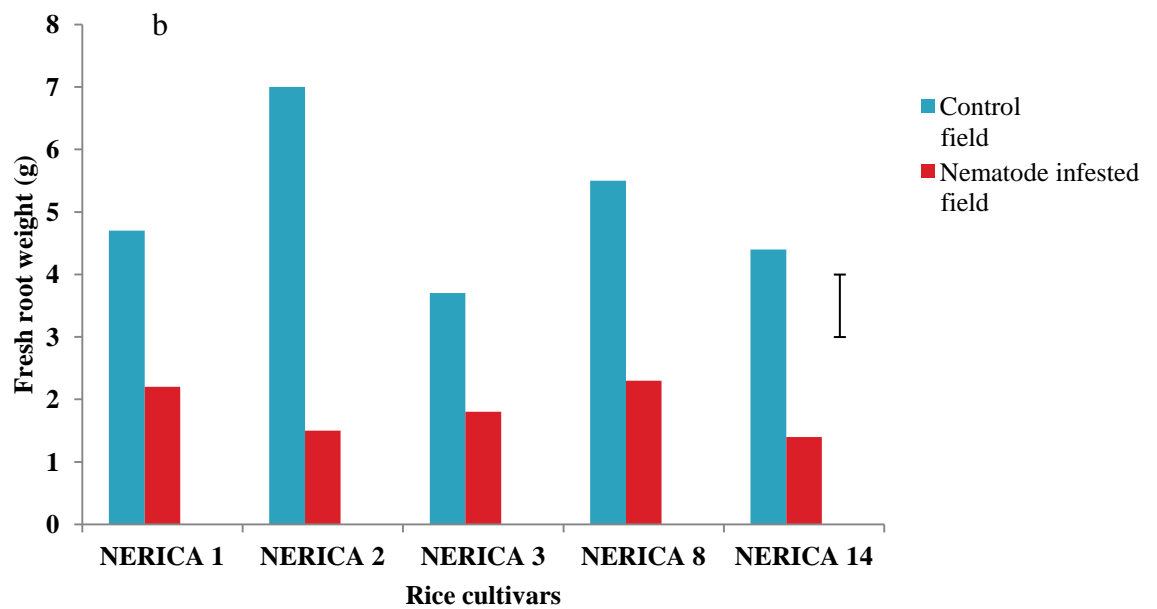
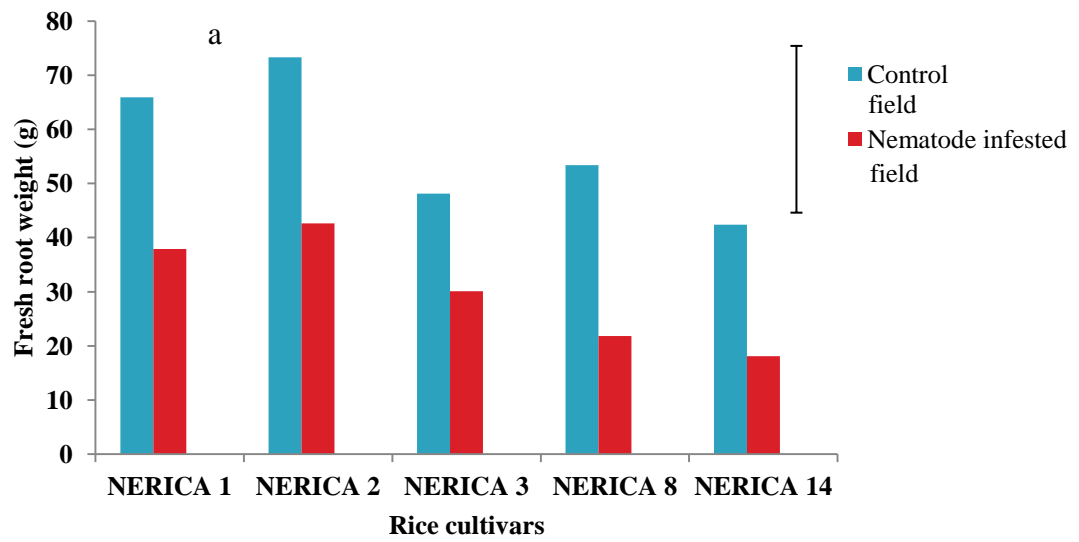

**Fig. 4.25: Effect of *Heterodera sacchari* on fresh root weight of five NERICA rice cultivars in the field at twelve weeks after planting. a = first trial, b = second trial,**

LSD bar for comparing means across cultivars

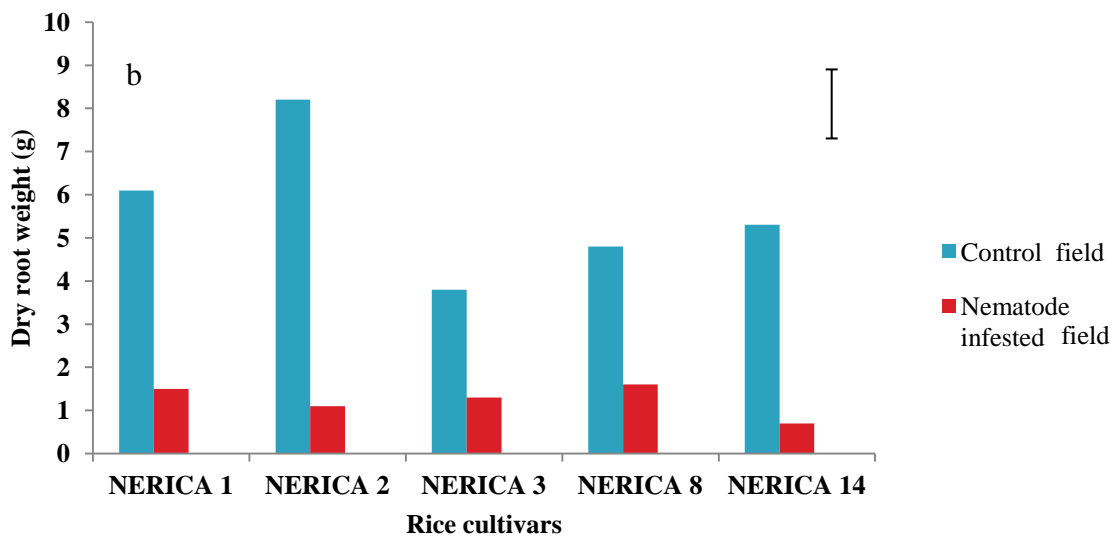
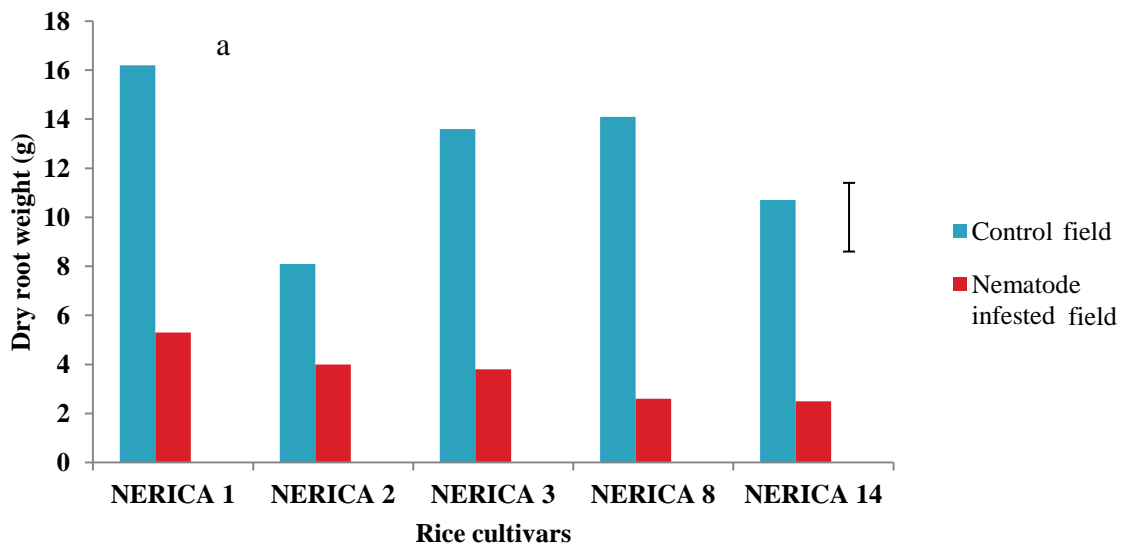

**Fig. 4.26: Effect of *Heterodera sacchari* on dry root weight of five NERICA rice cultivars in the field at twelve weeks after planting. a = first trial, b = second trial.**

LSD bar for comparing treatment means across cultivars.

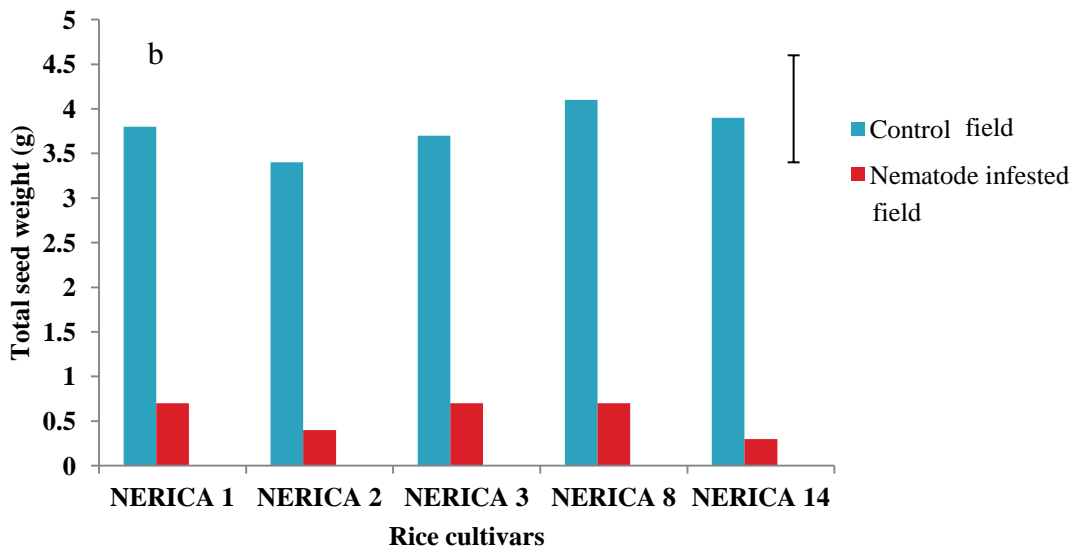
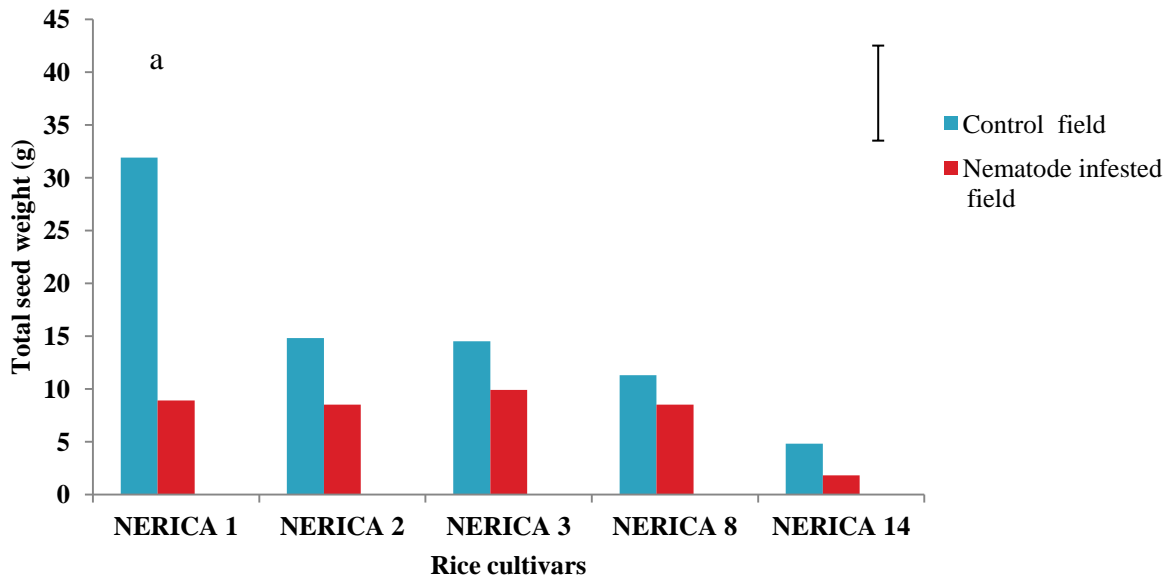

**Fig. 4.27: Effect of *Heterodera sacchari* on total seed weight of five NERICA rice cultivars in the field at twelve weeks after planting. a = first trial, b = second trial.**

LSD bar for comparing means across cultivars

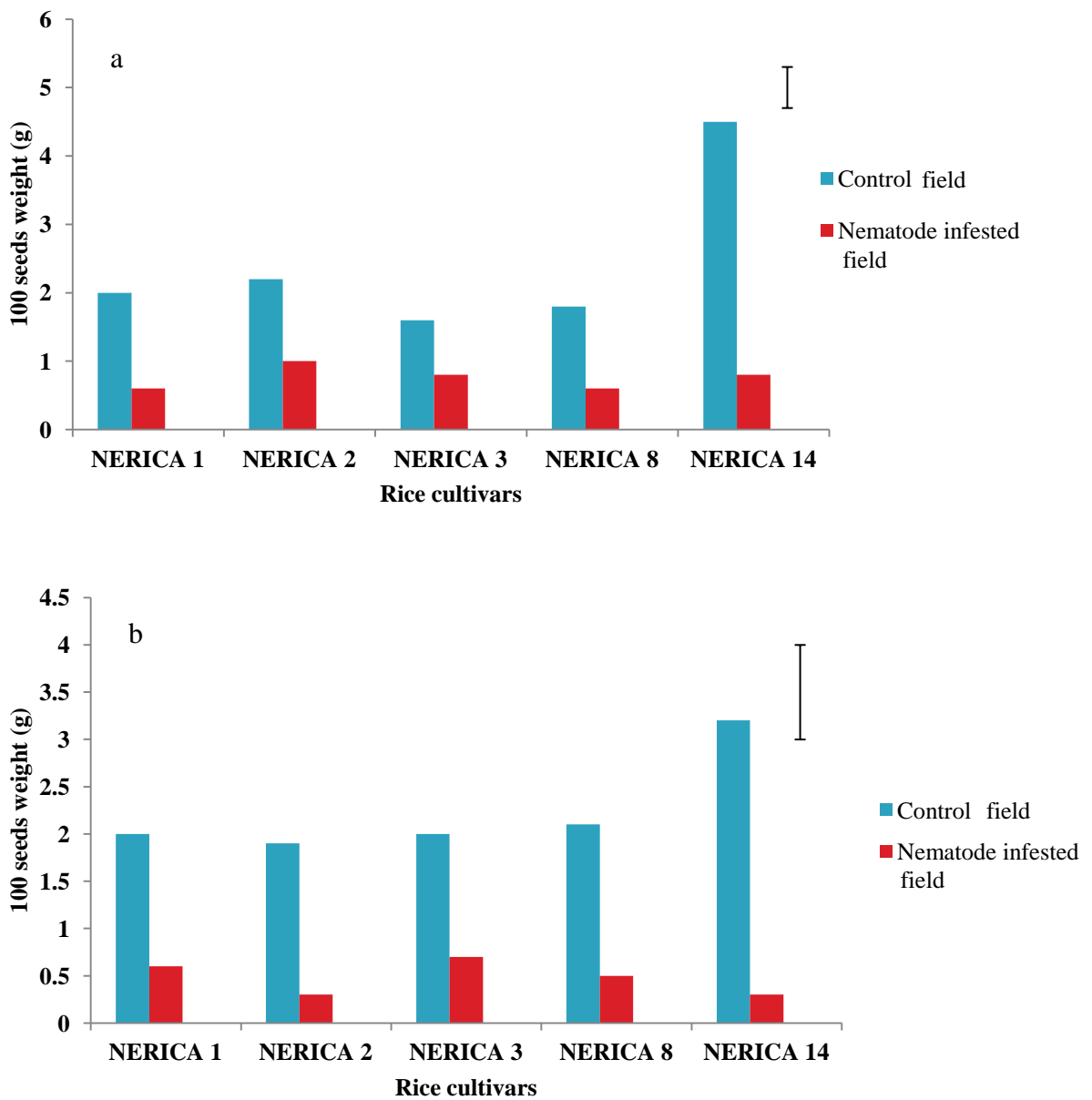

**Fig. 4.28: Effect of *Heterodera sacchari* on total 100-seed weight of five NERICA rice cultivars in the field at twelve weeks after planting. a = first trial, b = second trial**

LSD bar for comparing means across cultivars



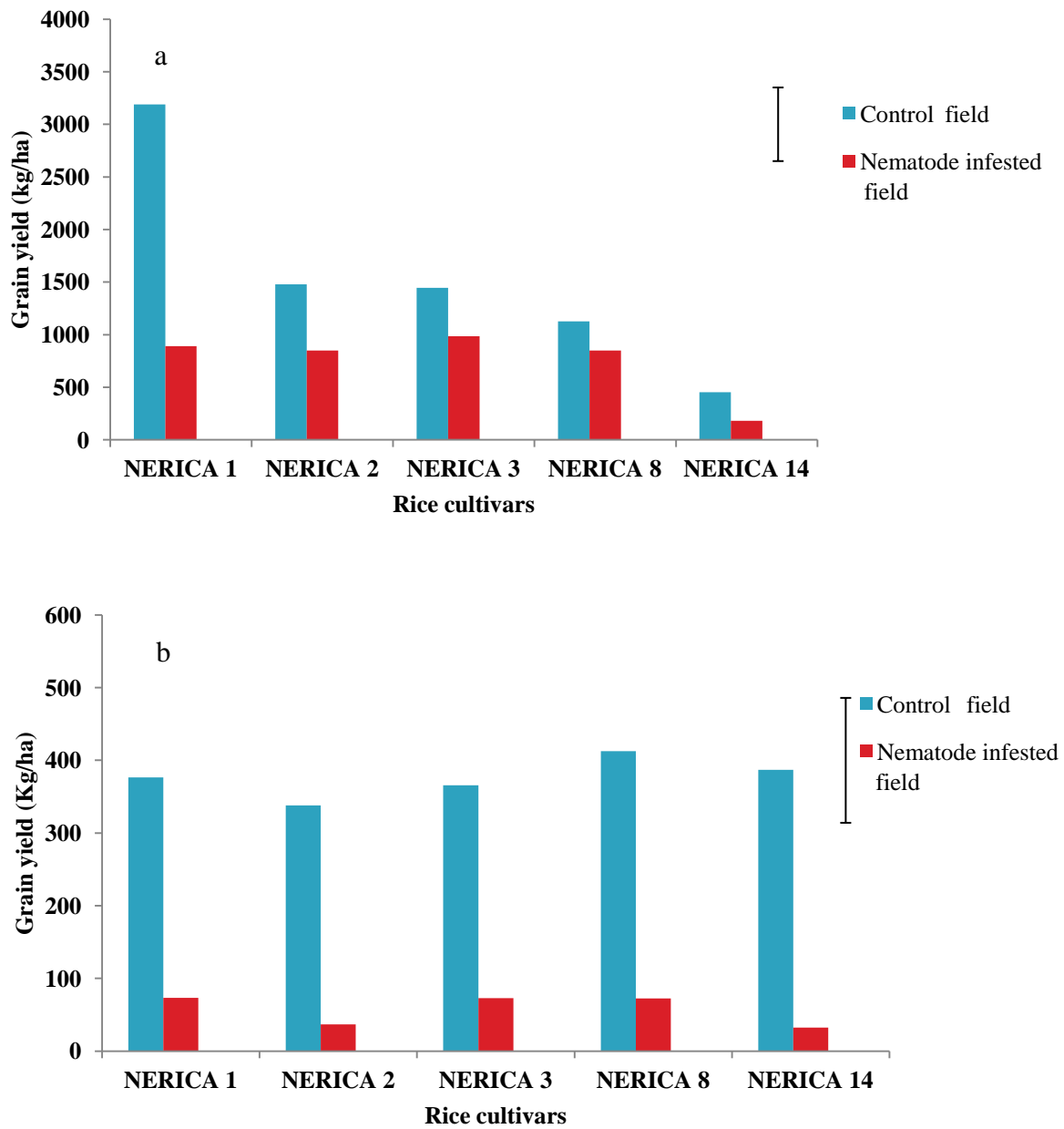
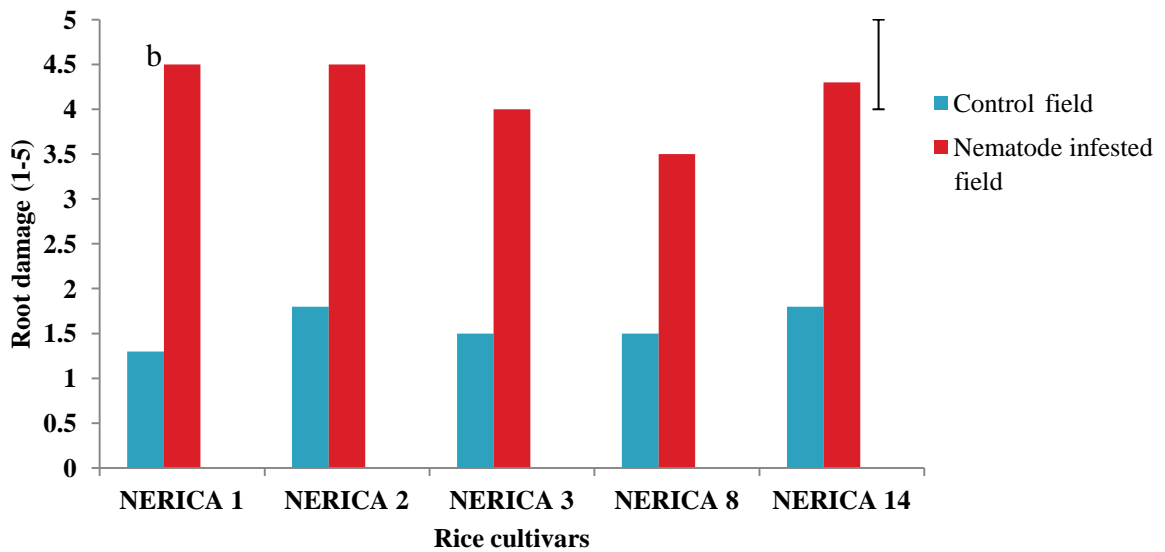
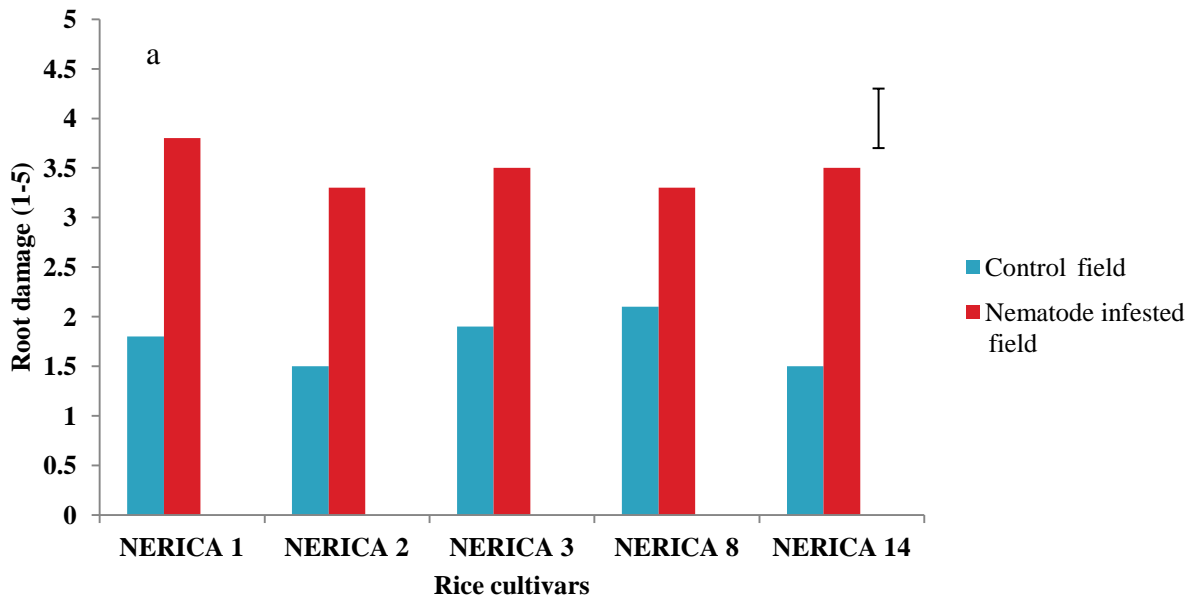

**Fig. 4.29: Effect of *Heterodera sacchari* on grain yield of five NERICA rice cultivars in the field at twelve weeks after planting. a = first trial, b = second trial**

LSD bar for comparing treatment means across cultivars

In the second trial, the grain yield per hectare obtained from the nematode-infested field was significantly lower ( $P \leq 0.05$ ) than the grain yield produced by rice plants grown in the control field (Fig. 4.29b). The root damage was significantly higher ( $P \leq 0.05$ ) in the nematode-infested field when compared with the control field across NERICA rice cultivars in the two trials (Fig. 4.30). Root damage was 3.3 (NERICA 8) to 3.8 (NERICA 1) in the nematode-infested field. In the control field, root damage ranged from 1.5 (NERICA 2 and NERICA 14) to 2.1 (NERICA 8) (Fig 4.30a). The initial second-stage juvenile ( $J_2$ ) population and initial cysts population recovered from 250 ml soil of nematode-infested field were significantly higher ( $P \leq 0.05$ ) than those obtained from the control field (denematized) in both trials (Table 4.5). The initial  $J_2$  population was between 42.5 to 78.8  $J_2 / 250$  ml soil in the nematode-infested field while in the denematized field, the initial  $J_2$  population in soil ranged from 0.0 to 3.8 juveniles / 250 ml soil (Table 4.5). The cyst production rating was significantly higher ( $P \leq 0.05$ ) in the NERICA rice cultivars grown on the nematode-infested field than those on the control field in the two trials (Table 4.5). The highest cyst production rating of 3.9 was obtained for NERICA 1 and the least cyst production rating of 3.4 was obtained on NERICA 8 grown in the nematode-infested field compared to rice cultivars grown in the control field, with cyst production rating of 1.7 in NERICA 8 and NERICA 14 then, 2.0 for NERICA 1 (Table 4.5).

The final  $J_2$  population recovered from both 250 ml of soil and root were not significantly different ( $P \leq 0.05$ ) in both nematode-infested and the denematized field across rice cultivars (except NERICA 2 and NERICA 3) in the first trial (Table 4.5). In the second trial, the final  $J_2$  population recovered from 250 ml of soil and root per plant were significantly ( $P \leq 0.05$ ) higher in the nematode-infested soil than the control across all the NERICA rice cultivars planted (Table 4.5). Similarly, the number of cysts recorded from 250 ml soil and total cysts on root of NERICA rice cultivars grown in the nematode-infested field were not significantly different from NERICA rice grown in the control field although, higher number of cysts were recorded from the nematode-infested field across all cultivars (Table 4.5). In the second trial, the final cysts population recovered from both root per plant and 250 ml of soil across all NERICA rice cultivars planted in the nematode-infested were significantly higher ( $P \leq 0.05$ ) than those recovered from the control field (Table 4.5).



**Fig. 4.30: Effect of *Heterodera sacchari* on root damage of five NERICA rice cultivars in the field at twelve weeks after planting. a = first trial, b = second trial**

LSD bar for comparing treatments means across cultivars, root damage (1-5) where; 1= clean, 2= (1-10% slight damage), 3= (11-30% mild damage), 4= (31-50% moderate root damage) and 5= (>51% severe root damage)

**Table 4.5: Reproduction of *Heterodera sacchari* on five NERICA rice cultivars in the field**

Cultivar	Treatment	Initial J <sub>2</sub> popul. in 250 ml soil	Initial cysts popul. in 250 ml soil	Cyst prodn. rating*	Final J <sub>2</sub> popul. (root+soil)	Final cyst popul. from 250 ml soil + roots	Number of eggs and J <sub>2</sub> /cyst
<b>Fisrt trial (2010)</b>							
NERICA 1	Control	1.3	38.3	2.0	1300.0	397.8	308.0
	Nematode infested	42.5	45.8	3.9	3925.0	458.5	369.0
NERICA 2	Control	2.5	37.8	1.8	1450.0	378.3	331.8
	Nematode infested	43.8	51.0	3.8	2300.0	469.8	379.0
NERICA 3	Control	2.5	36.8	1.8	1500.0	375.8	266.3
	Nematode infested	78.8	43.5	3.5	3775.0	452.6	320.5
NERICA 8	Control	0.0	39.3	1.7	887.5	306.3	197.3
	Nematode infested	77.5	74.5	3.4	1737.5	424.1	247.5
NERICA 14	Control	3.8	48.3	1.7	1400.0	474.5	257.0
	Nematode infested	70.0	56.0	3.5	3050.0	539.8	399.0
LSD (P≤0.05)		18.6	18.9	0.7	1958.2	287.2	195.3
<b>Second trial (2011)</b>							
NERICA 1	Control	1.3	100.0	2.8	2100.0	150.0	266.3
	Nematode infested	65.0	149.0	4.0	3750.0	800.0	293.3
NERICA 2	Control	7.5	16.3	2.5	2250.0	375.0	273.8
	Nematode infested	72.5	145.3	4.0	4250.0	825.0	533.0
NERICA 3	Control	1.3	13.8	3.0	3000.0	225.0	325.3
	Nematode infested	85.0	127.8	4.0	4750.0	950.0	328.3
NERICA 8	Control	2.5	27.0	1.8	2000.0	225.0	265.3
	Nematode infested	87.5	106.3	3.5	2750.0	525.0	301.0
NERICA 14	Control	2.5	20.0	2.8	2500.0	500.0	405.3
	Nematode infested	55.0	130.0	4.0	4250.0	1000.0	545.0
LSD (P≤0.05)		21.2	39.3	1.0	630.4	191.8	291.6

LSD bar for comparing treatment means across. J<sub>2</sub> = second-stage juveniles, \*cyst production rating = 0 = no cyst, 1 = 1-2 cysts, 2 = 3-10 cysts, 3 = 11–30 cysts, 4 = 31 cysts and above

Furthermore, in the control, number of nematodes recovered per cyst was not significantly different ( $P \leq 0.05$ ) from those recovered from the nematode-infested field across all cultivars in both trials (Table 4.5). The number of eggs and juveniles counted per cyst was higher in the cysts recovered from nematode-infested field than those obtained from the control field in both trials (Tables 4.5).

#### **4.4: Effect of interaction between *Heterodera sacchari* and *Botryodiplodia theobromae* on growth, yield and nematode reproduction on NERICA rice cultivars (Pot)**

The plant height of NERICA rice inoculated with *H. sacchari* alone, *H. sacchari* before *B. theobromae*, *B. theobromae* before *H. sacchari* and *H. sacchari* plus *B. theobromae* inoculated simultaneously were significantly shorter ( $P \leq 0.05$ ) than the heights obtained for *B. theobromae* alone and uninoculated rice plants in the two trials (Figs. 4.31a and b). The mean plant height for various treatments recorded at two weeks after inoculation were not significantly different ( $P \leq 0.05$ ) from one another (Fig. 4.31a). However, plants inoculated with *B. theobromae* alone and the control were taller than other treatments (Figs. 4.31a and 4.31b). At eight weeks after planting, the values obtained from plants inoculated with the fungus alone and the control were not significantly different from each other but were significantly taller ( $P \leq 0.05$ ) than the height of rice inoculated with *H. sacchari* alone, *H. sacchari* and *B. theobromae* inoculated simultaneously, inoculation with *H. sacchari* plus *B. theobromae* at one week after nematode inoculation and *B. theobromae* plus *H. sacchari* at one week after the fungus inoculation in both trials (Figs. 4.31a and 4.31b). This continued until the end of the experiment when uninoculated plants attained the highest plant height of 59.7 cm, followed by *B. theobromae* alone plants (56.9 cm). These values were significantly ( $P \leq 0.05$ ) higher than values obtained from *B. theobromae* before *H. sacchari* a week after the fungus inoculation (16.1 cm tall) and *H. sacchari* alone (20.5 cm tall) inoculated plants (Fig. 4.31a).

At two weeks after inoculation, leaf production in inoculated NERICA rice cultivars was not significantly different from the control plants in both trials (Figs. 4.32a and 4.32b). However, at eight weeks after inoculation (WAI), the control treatment produced significantly higher ( $P \leq 0.05$ ) number of leaves than the inoculated rice plants in both trials (Fig 4.32) except the NERICA rice plants inoculated with *B. theobromae* alone that were

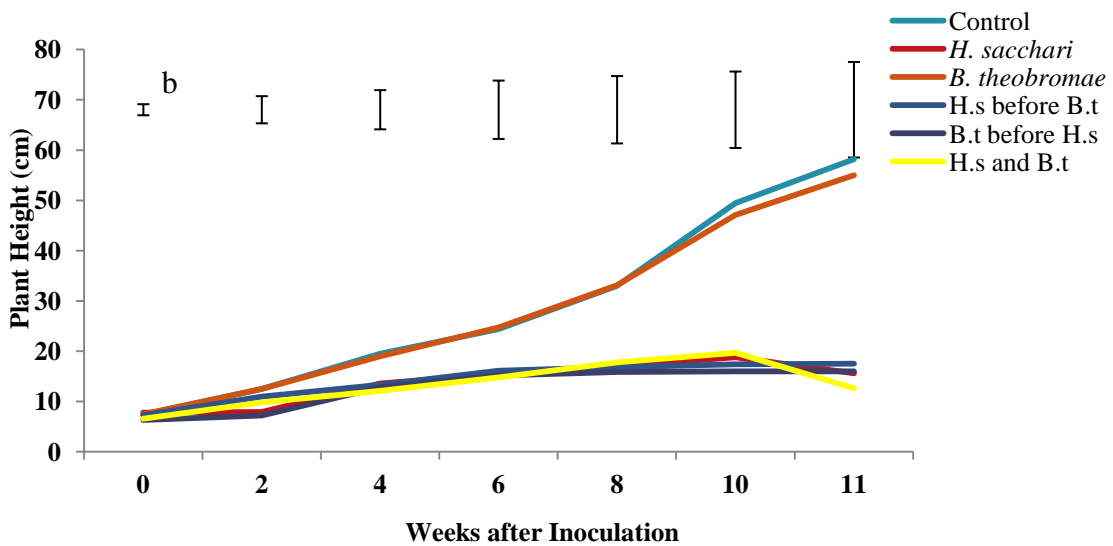
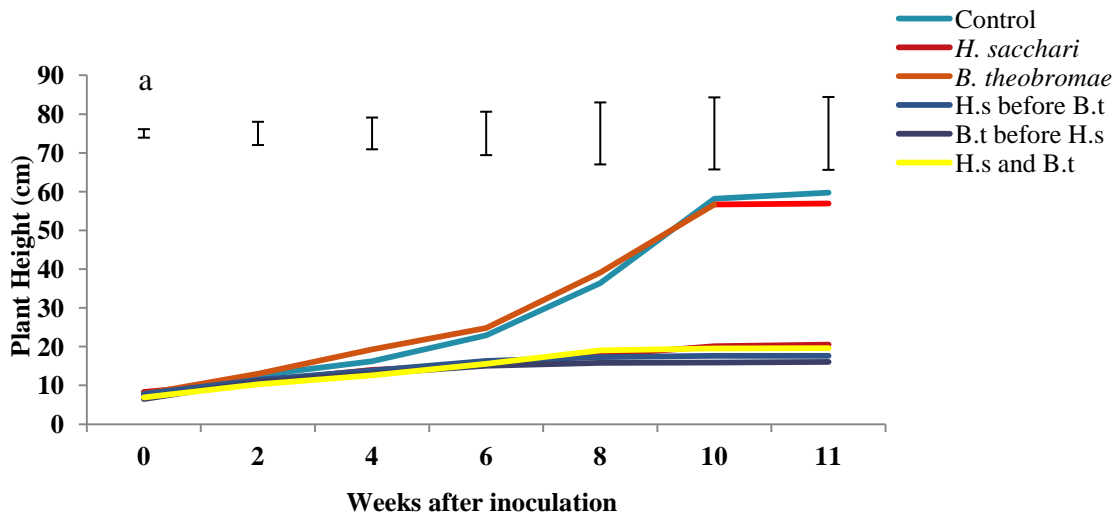

**Fig. 4.31: Effects of interaction between *Heterodera sacchari* and *Botryodiplodia theobromae* on height of NERICA rice cultivars. a = first trial, b = second trial**

LSD bars are for comparing treatment means at each specific time. 5,000 *Heterodera sacchari* (H.s) eggs and second-stage juveniles,  $5 \times 10^5$  *Botryodiplodia theobromae* (B.t) spores.

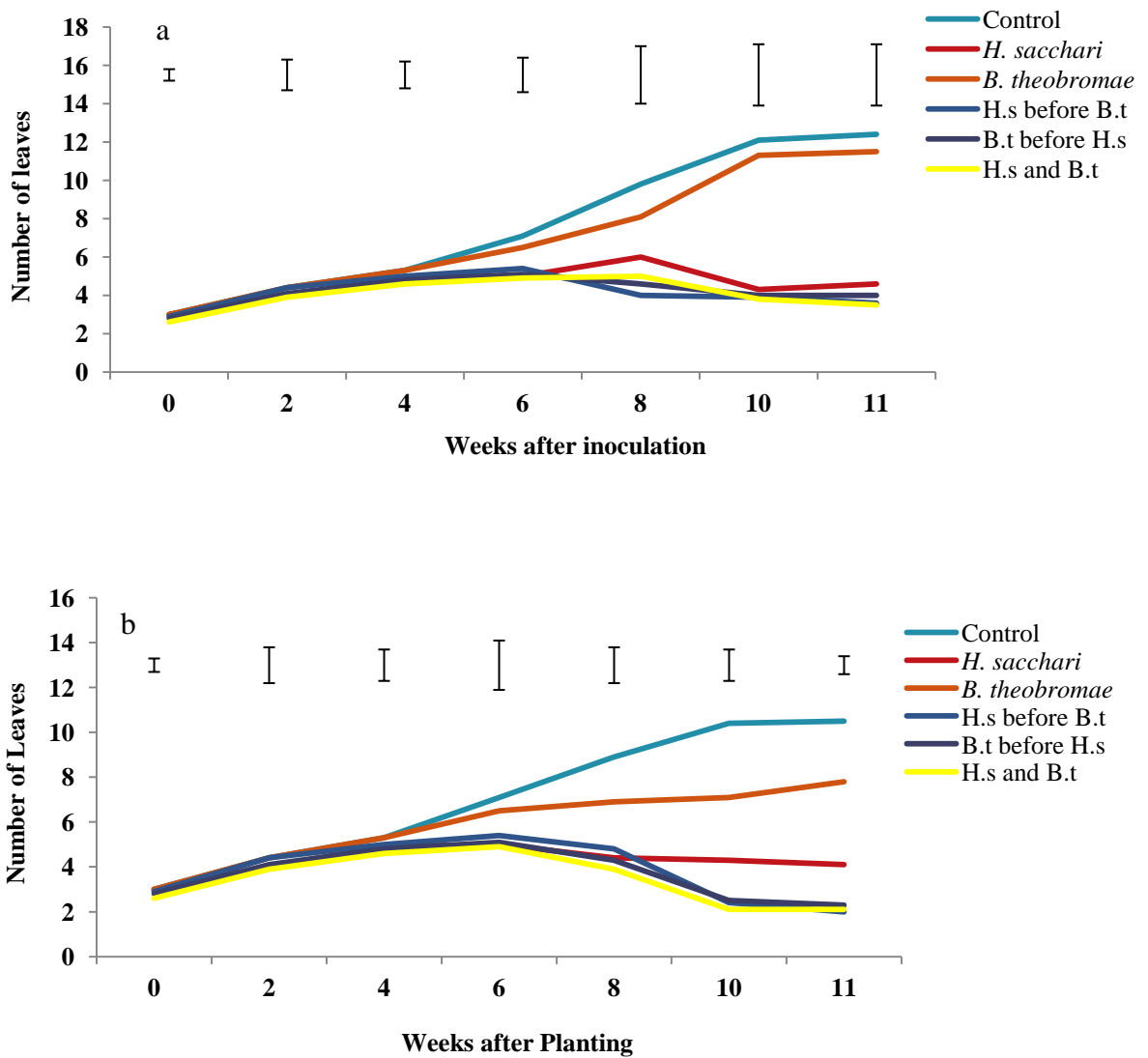

**Fig. 4.32: Effects of interaction between *Heterodera sacchari* and *Botryodiplodia theobromae* on leaf production of some NERICA rice cultivars. a = first trial, b = second trial**

LSD bars are for comparing treatment means at each specific time. 5,000 *Heterodera sacchari* (H.s) eggs and second-stage juveniles,  $5 \times 10^5$  *Botryodiplodia theobromae* (B.t) spores.

not significantly different from the control (Fig. 4.32a and 4.32b). In the second trial, all inoculated rice plants produced significantly lower ( $P \leq 0.05$ ) number of leaves than the uninoculated plants from 8 WAI till the end of the experiment (Fig. 4.32b).

At eight weeks after inoculation, the leaf chlorophyll content of control plants were statistically higher than [43.1 (first trial) and 40.4 (second trial)] the plants inoculated with *H. sacchari* alone, *B. theobromae* alone and nematode/fungus inoculation at various sequential combinations in both trials (Figs. 4.33a and 4.33b). Furthermore, at 10 WAI, the uninoculated NERICA rice plants recorded mean leaf chlorophyll content of 44.7 which was significantly ( $P \leq 0.05$ ) better than all inoculated NERICA rice plants until end of the experiment in the two trials. (Fig. 4.33a). The plants inoculated with *B. theobromae* alone and the uninoculated plants were not statistically different ( $P > 0.05$ ) from each other for number of tillers, fresh shoot, dry shoot, fresh root and dry root weights in both trials (Table 4.6). Rice plants inoculated with *H. sacchari* alone, *H. sacchari* / *B. theobromae* in various sequential combinations were significantly lower ( $P \leq 0.05$ ) in number of tillers, fresh shoot, dry shoot, fresh root and dry root weights when compared with the control plants (Table 4.6). The number of panicles and the weight of 50 seeds of NERICA rice obtained from inoculated plants had a significantly lower ( $P \leq 0.05$ ) number of panicles and weight of 50 seeds as compared with the uninoculated plants (Table 4.6). Furthermore, total seed weight and days to flowering were not significantly different ( $P > 0.05$ ) in both control plants and the plants inoculated with *B. theobromae* alone, although their means were significantly higher ( $P \leq 0.05$ ) than the plants from other treatments in the two trials (Table 4.6). Rice plants inoculated with *H. sacchari* alone took an average of 107.5 days to flower. This was closely followed by *H. sacchari* plus *B. theobromae* simultaneous inoculation (103.3 days). *Heterodera sacchari* plus *B. theobromae* at one week after nematode inoculation and *B. theobromae* plus *H. sacchari* at one week after the fungus inoculation did not flower till the end of the experiment when compared with the control plants that flowered earliest (89.6 days). This was closely followed by *B. theobromae* alone treated plants (90.6 days) which also flowered earlier than other treatments (Table 4.6).



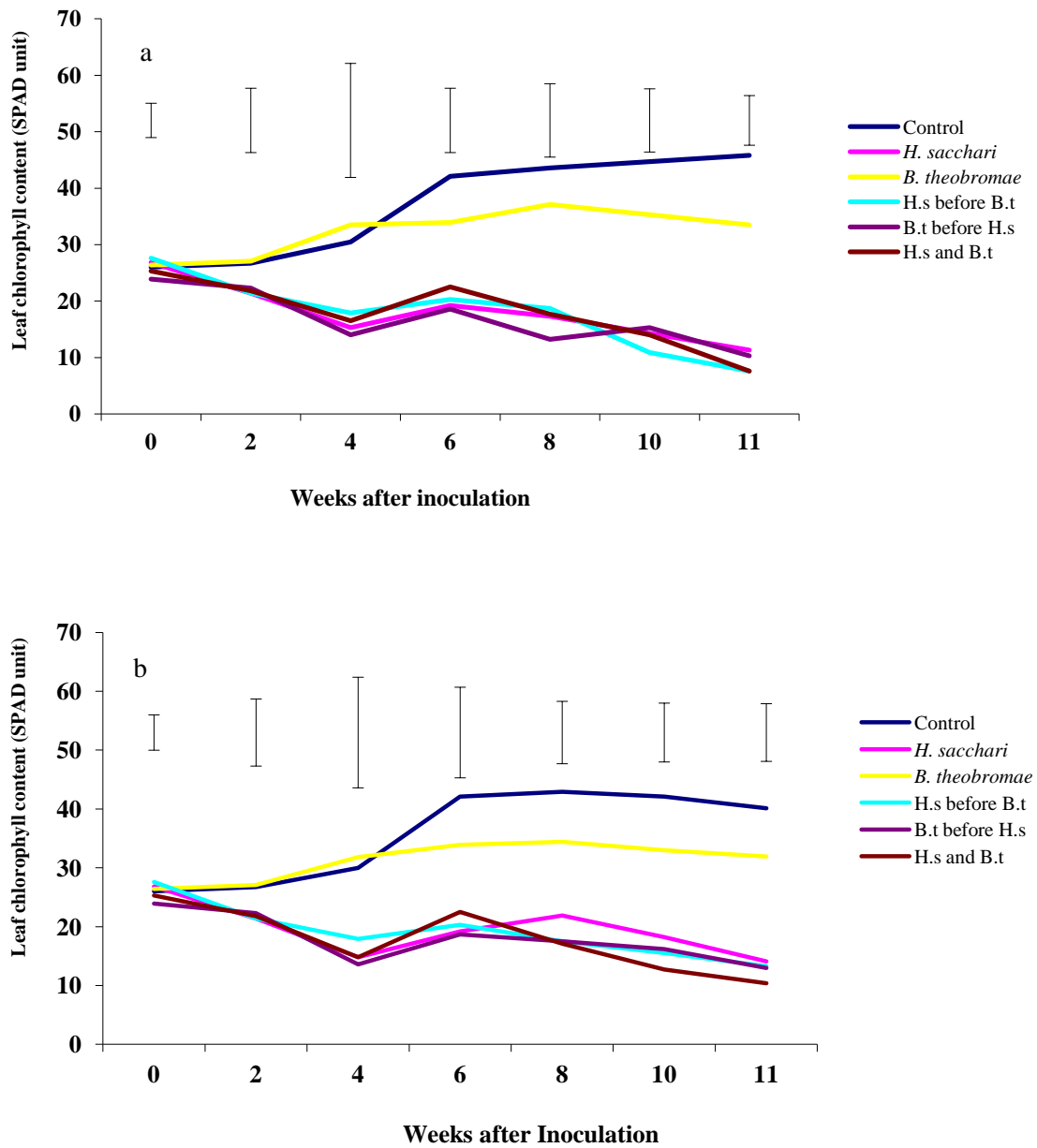

**Fig. 4.33: Effect of interaction between *Heterodera sacchari* and *Botryodiplodia theobromae* on leaf chlorophyll content of NERICA rice cultivars. a = first trial, b = second trial**

LSD bars are for comparing treatment means at each specific time, 5,000 *Heterodera sacchari* (H.s) eggs and second-stage juveniles,  $5 \times 10^5$  *Botryodiplodia theobromae* (B.t) spores.

**Table 4.6: Effects of interaction between *H. sacchari* and *B. theobromae* on growth and yield of NERICA rice cultivars**

Treatment	Number of Tillers	Fresh Shoot weight (g)	Dry Shoot Weight (g)	Fresh Root weight (g)	Dry Root weight (g)	Number of Panicles	Total Seed Weight (g)	50 seeds weight (g)	Days to flowering
<b>First trial (2010)</b>									
Control	3.4	21.9	5.0	10.6	1.2	2.4	4.9	1.6	89.6
<i>H. sacchari</i>	0.9	3.7	1.0	2.5	0.2	0.0	0.4	0.2	107.5
<i>B. theobromae</i>	3.3	19.7	4.5	10.1	1.2	1.8	4.7	1.2	90.6
H.s before B.t	0.5	3.1	0.7	1.5	0.1	0.0	0.0	0.0	0.0
B.t before H.s	0.4	3.5	0.8	1.6	0.1	0.0	0.0	0.0	0.0
H.s and B.t	0.0	3.0	1.0	2.2	0.2	0.1	0.2	0.2	103.3
LSD (P≤0.05)	1.5	5.1	1.2	3.1	0.3	0.5	1.2	0.3	5.2
<b>Second trial (2011)</b>									
Control	3.4	22.5	4.9	10.3	1.7	2.9	6.8	2.9	89.8
<i>H. sacchari</i>	1.3	6.8	1.1	3.2	0.6	0.8	1.2	0.6	105.0
<i>B. theobromae</i>	3.3	18.4	4.1	8.8	1.2	1.5	4.8	1.7	90.6
H.s before B.t	0.1	3.0	0.6	1.1	0.2	0.1	0.0	0.0	0.0
B.t before H.s	0.1	2.4	0.8	0.9	0.1	0.1	0.0	0.0	0.0
H.s and B.t	0.0	3.0	0.9	1.1	0.2	0.0	0.0	0.0	0.0
LSD (P≤0.05)	1.4	5.1	1.0	2.9	0.4	0.5	1.4	0.3	5.4

H.s = 5000 *Heterodera sacchari* eggs and second-stage juveniles (J<sub>2</sub>), B.t = 5X10<sup>5</sup> *Botryodiplodia theobromae* spores, H.s before B.t = 5000 *Heterodera sacchari* eggs/J<sub>2</sub> before 5X10<sup>5</sup> *Botryodiplodia theobromae* spores, B.t before H.s = 5X10<sup>5</sup> *Botryodiplodia theobromae* spores before 5000 *Heterodera sacchari* eggs/J<sub>2</sub>, H.s and B.t = 5000 *Heterodera sacchari* eggs/J<sub>2</sub> and 5X10<sup>5</sup> *Botryodiplodia theobromae* spores simultaneously, LSD for comparing treatment means within each column

The disease index of plants inoculated with either *H. sacchari* alone, *B. theobromae* alone or both organisms in combination had a significantly higher ( $P \leq 0.05$ ) root damage than the control plants in the two trials (Table 4.7). Similarly, cyst production was also significantly higher in plants that were inoculated with *H. sacchari* alone or in combination with fungus than the control plants (Table 4.7).

Total second-stage juveniles ( $J_2$ ) in pots of plants inoculated with *H. sacchari* alone or in sequential combination with *B. theobromae* were significantly higher than the  $J_2$  population in the uninoculated plants and *B. theobromae* alone inoculated plants (Table 4.7). Furthermore, total cysts in pot and number of nematodes per cyst of plants inoculated with either *H. sacchari* alone or in combination with *B. theobromae* were significantly higher than the uninoculated plants (Table 4.7). However, the *H. sacchari* alone-treated plants had the highest number of nematodes per cyst in both trials (Table 4.7).

#### **4.4.1: Effects of interaction between *Heterodera sacchari* and *Botryodiplodia theobromae* on growth, yield and nematode reproduction on two NERICA rice cultivars in pot.**

Infected NERICA 1 and NERICA 2 rice cultivars were significantly shorter ( $P \leq 0.05$ ) in heights than the heights obtained for uninfected NERICA 1 and NERICA 2 rice cultivars at the end of the experiment in the two trials (Figs. 4.34a and 4.34b). The NERICA 2 rice infected with *H. sacchari* alone was taller than NERICA 1 infected *H. sacchari* alone and when the two organisms were present together, although there were no significant differences in the infected NERICA rice cultivars in the two trials (Figs. 4.34a and 4.34b)

The leaf production of uninfected NERICA 1 and NERICA 2 rice cultivars and *B. theobromae* alone infected rice were significantly ( $P \leq 0.05$ ) higher than the other treatments in the two trials (Fig. 4.35a and 4.35b). NERICA 1 infected with *H. sacchari* alone produced more leaves than NERICA 2 rice infected with the two organisms in the first trial (Fig. 4.35a) while in the second trial, NERICA 2 rice infected with *H. sacchari* alone produced more leaves than NERICA 1 infected with *H. sacchari* alone at the end of the experiment (Fig. 4.35b).

**Table 4.7: Effects of interaction between *Heterodera sacchari* and *Botryodiplodia theobromae* on disease index and Nematode reproduction on NERICA rice cultivars**

Treatment	*D I	**Cyst Production rating	Total J <sub>2</sub> in pot (root + soil)	Total Cysts in pot (root +soil)	Number of eggs and J <sub>2</sub> per cyst
<b>First trial (2010)</b>					
Control	0.0	0.0	0.0	0.0	0.0
<i>H. sacchari</i>	3.6	4.0	10344.0	18050.0	310.6
<i>B. theobromae</i>	1.8	0.0	0.0	0.0	0.0
H.s before B.t	4.1	4.0	7656.0	11700.0	267.9
B.t before H.s	3.9	4.0	10719.0	18788.0	271.1
H.s and B.t	3.9	3.5	11247.0	14570.0	270.1
LSD (P≤0.05)	0.5	0.6	5779.0	7176.8	44.7
<b>Second trial (2011)</b>					
Control	0.0	0.0	0.0	0.0	0.0
<i>H. sacchari</i>	3.8	4.0	15760.0	37425.0	290.3
<i>B. theobromae</i>	1.9	0.0	0.0	0.0	0.0
H.s before B.t	4.6	4.0	9531.0	18050.0	269.9
B.t before H.s	4.3	4.0	11406.0	12613.0	273.1
H.s and B.t	4.3	3.0	9253.0	12698.0	315.1
LSD (P≤0.05)	0.6	0.2	6847.7	3176.8	43.1

LSD for comparing treatment means within each column, \*Disease index (DI) where; 0 = No visible lesions, 1 = Lesions 1 mm long, light brown, 2 = Lesions 1 to 5mm long, brown, 3 = Lesions longer than 5mm, dark brown, 4 = Root totally infected and brown, 5 = Root totally destroyed and plant dying or dead. \*\*Cyst production: 0 = no cyst (Resistant); 1 = 1-2 cysts (Moderately Resistant); 2 = 3-10 cysts (Moderately Susceptible); 3= 11-30 cysts (Susceptible); 4 = 31 cysts and above (Highly susceptible). 5000 *Heterodera sacchari* (H.s) eggs and second-stage juveniles, B.t = 5X10<sup>5</sup> *Botryodiplodia theobromae* (B.t) spores, J<sub>2</sub> = second-stage juveniles.

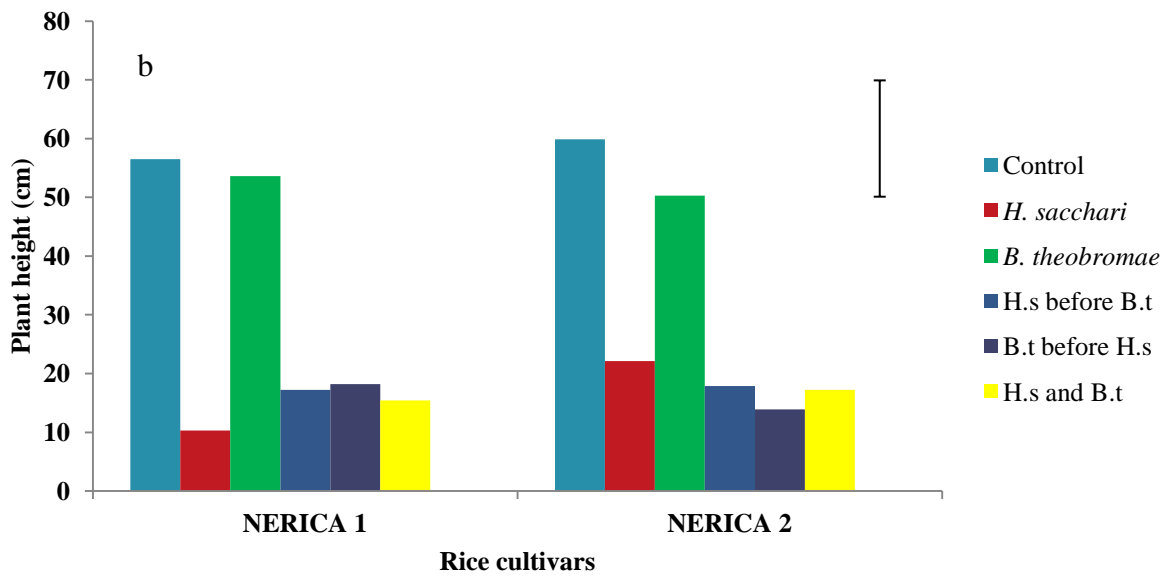
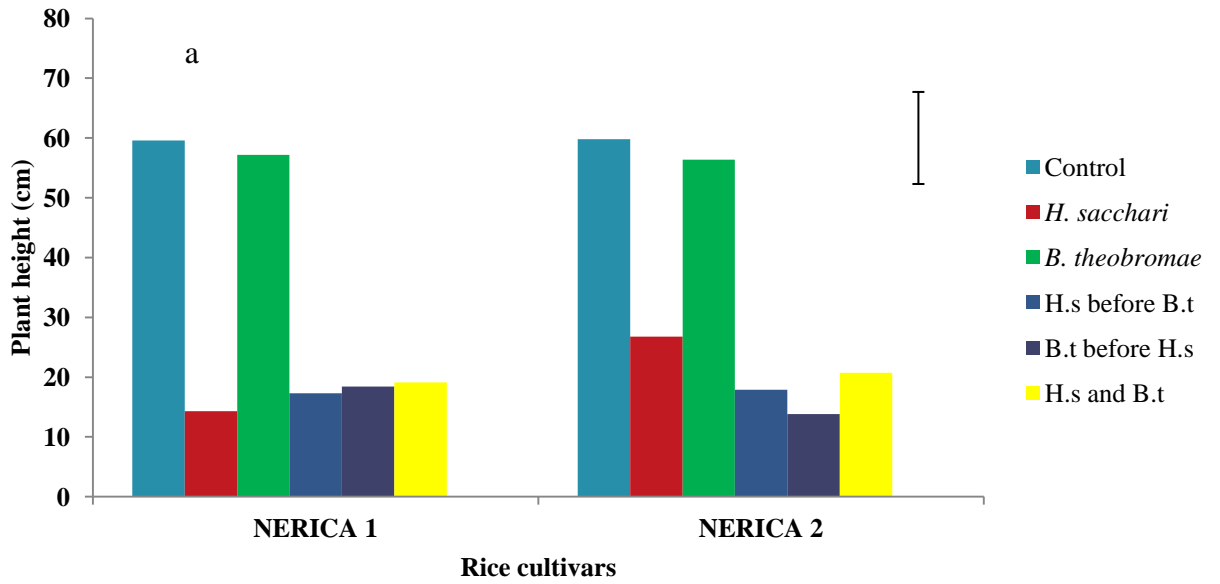

**Fig. 4.34: Effects of interaction between *Heterodera sacchari* and *Botryodiplodia theobromae* on height of NERICA 1 and NERICA 2 rice cultivars at eleven weeks after planting. a = first trial, b = second trial**

LSD bar for comparing treatment means across cultivars, 5000 *Heterodera sacchari* (H.s) eggs and second-stage juveniles,  $5 \times 10^5$  *Botryodiplodia theobromae* (B.t) spores.

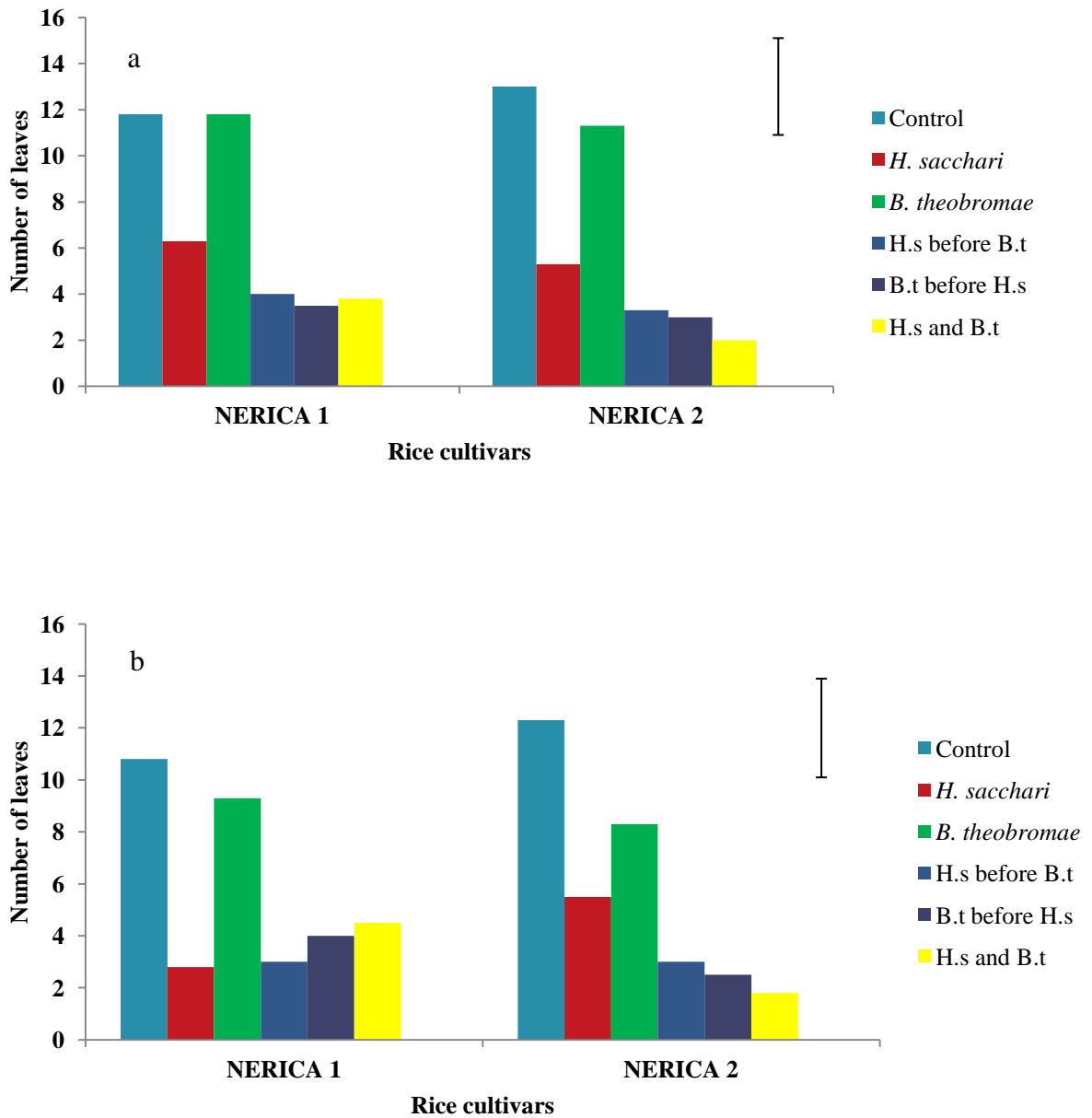

**Fig. 4.35: Effects of interaction between *Heterodera sacchari* and *Botryodiplodia theobromae* on leaf production of two NERICA rice cultivars at eleven weeks after planting. a = first trial, b = second trial**

LSD bar for comparing treatment means across cultivars, 5000 *Heterodera sacchari* (H.s) eggs and second-stage juveniles,  $5 \times 10^5$  *Botryodiplodia theobromae* (B.t) spores.

At the eleventh week after infection, the leaf chlorophyll content of uninfected NERICA rice cultivars were significantly higher ( $P \leq 0.05$ ) than the infected NERICA rice in the two trials (Fig. 4.36a and 4.36b). There were no significant differences between the leaf chlorophyll content of infected NERICA 1 and NERICA 2 rice cultivars in the presence of *H.sacchari* alone, *B. theobromae* alone and when the two organisms were present together in various sequential combinations (Fig. 4.36a). The control of NERICA 2 rice had significantly higher ( $P \leq 0.05$ ) leaf chlorophyll content than the respective inoculated NERICA 2 plants in the first trial (Fig. 4.36a). Similar observation was made in the second trial.

The uninfected NERICA rice and *B. theobromae* alone-infected plants produced a significantly higher ( $P \leq 0.05$ ) number of tillers than the other treatments in both trials (Tables 4.8 and 4.9). Furthermore, uninfected NERICA 2 and NERICA 1 rice produced 4.0 and 2.8 tillers respectively while the infected rice cultivars produced tillers which ranged from 0.0 tillers to 3.8 tillers (Table 4.8). Similar observation was made in the second trial. The number of panicles produced by uninfected rice cultivars was significantly ( $P \leq 0.05$ ) higher than those infected with *H. sacchari* alone (0.0), *H. sacchari* plus *B. theobromae* a week after nematode inoculation (0.0 panicles), *B. theobromae* plus *H. sacchari* a week after fungus inoculation (0.0 panicles) and *B. theobromae* plus *H. sacchari* simultaneously (0.0 panicles) (Table 4.8). However, lower number of panicles was produced by infected rice plants with *B. theobromae* alone (1.8 panicles) though not significantly different ( $P \leq 0.05$ ) from the number of panicles produced by the uninfected NERICA 1 rice (Table 4.8). Similar observation was made in the second trial.

There were no significant differences ( $P \leq 0.05$ ) between the infected NERICA 1 and NERICA 2 rice cultivars in fresh and dry shoot weights (Table 4.8). The two uninfected rice plants were not significantly different ( $P \leq 0.05$ ) in fresh and dry shoot weights in the two trials. Similarly, uninfected NERICA rice plants were not significantly different ( $P \leq 0.05$ ) in both fresh and dry root weights and also, the fresh and dry root weights of infected NERICA 1 and NERICA 2 rice cultivars were not significantly different from one another at the end of the experiments in the two trials (Tables 4.8 and 4.9).

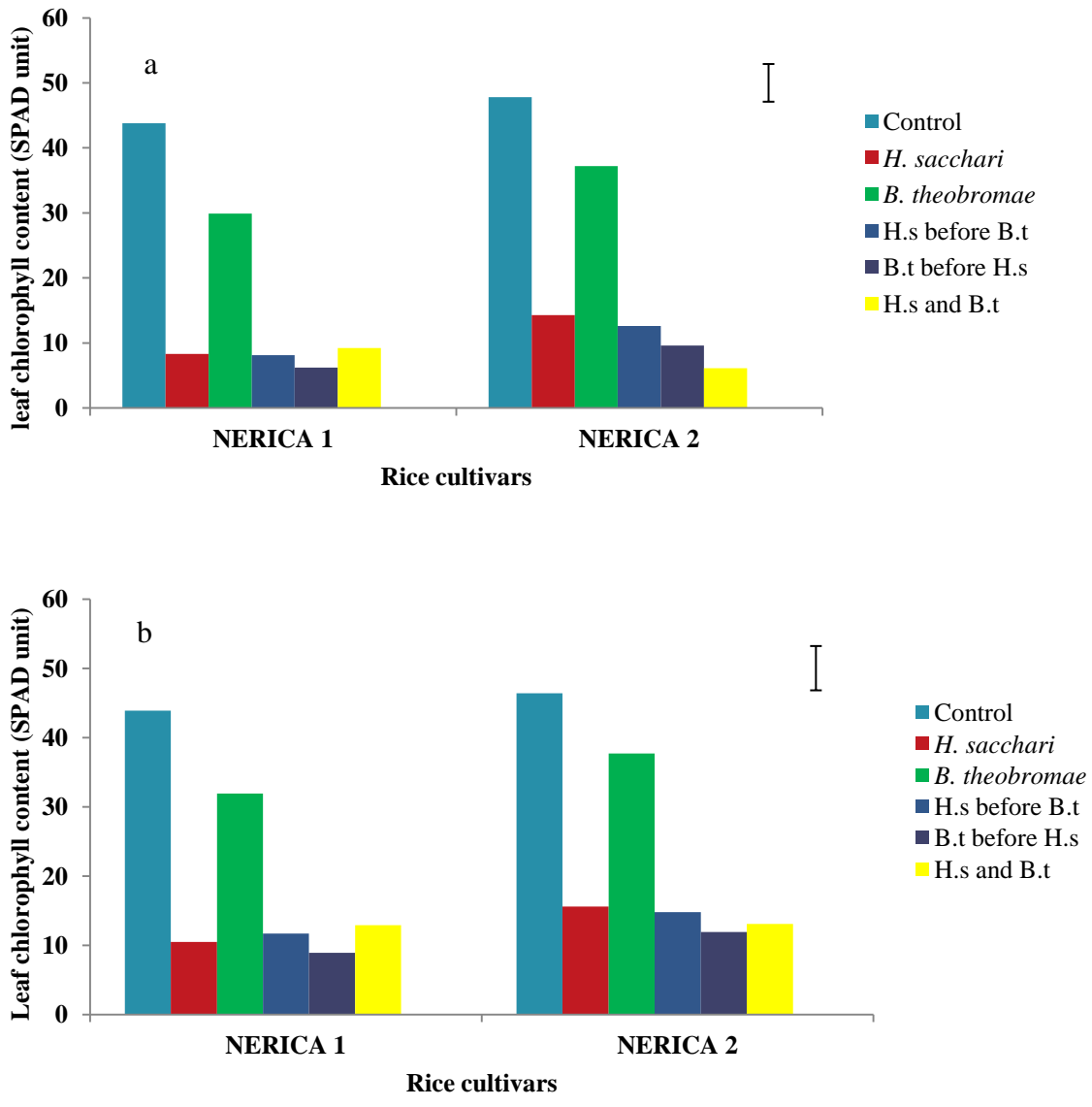

**Fig. 4.36: Effects of interaction between *Heterodera sacchari* and *Botryodiplodia theobromae* on leaf chlorophyll content of two NERICA rice cultivars at eleven weeks after planting. a = first trial, b = second trial**

LSD bar for comparing treatment means across cultivars, 5000 *Heterodera sacchari* (H.s) eggs and second-stage juveniles,  $5 \times 10^5$  *Botryodiplodia theobromae* (B.t) spores.



**Table 4.8: Effects of *Heterodera sacchari* and *Botryodiplodia theobromae* interaction on growth and yield parameters of two NERICA rice cultivars (first trial)**

Cultivar	Treatment	Number of Tillers	Number of Panicles	Fresh Shoot weight (g)	Dry Shoot Weight (g)	Fresh Root weight (g)	Dry Root Weight (g)	Total Seed Weight (g)	50 seeds weight (g)	Days to flowering
NERICA 1	Control	2.8	2.3	21.5	4.8	11.8	1.5	4.4	1.7	89.0
	<i>H. sacchari</i>	0.0	0.3	4.4	1.1	2.5	0.2	0.5	0.3	104.0
	<i>B. theobromae</i>	2.8	1.8	18.1	4.2	8.1	0.9	3.8	1.2	93.8
	H.s before B.t	0.0	0.0	2.0	0.6	1.6	0.1	0.0	0.0	dnf
	B.t before H.s	0.5	0.0	3.3	0.8	2.1	0.1	0.0	0.0	dnf
	H.s and B.t	0.0	0.0	3.0	0.7	1.3	0.1	0.0	0.0	dnf
NERICA 2	Control	4.0	2.5	22.3	5.3	13.2	1.5	5.7	1.6	87.5
	<i>H. sacchari</i>	1.8	0.3	5.4	1.4	3.1	0.3	0.3	0.2	107.0
	<i>B. theobromae</i>	3.8	1.8	21.2	4.7	8.5	0.9	5.4	1.1	90.3
	H.s before B.t	0.0	0.0	2.9	0.8	1.1	0.1	0.0	0.0	dnf
	B.t before H.s	0.3	0.3	1.7	0.5	1.4	0.1	0.0	0.0	dnf
	H.s and B.t	0.0	0.0	2.7	0.9	1.3	0.1	0.0	0.0	dnf
LSD (P≤0.05)		1.9	0.6	6.8	1.6	4.9	0.5	1.5	0.4	8.0

LSD for comparing treatment means within the same column, 5,000 *Heterodera sacchari* (H.s) eggs and second-stage juveniles (J<sub>2</sub>), 5X10<sup>5</sup> *Botryodiplodia theobromae* (B.t) spores, dnf = did not flower

**Table 4.9: Effects of *Heterodera sacchari* and *Botryodiplodia theobromae* interaction on growth and yield parameters of two NERICA rice cultivars (second trial)**

Cultivar	Treatment	Number of Tillers	Number of Panicles	Fresh Shoot weight (g)	Dry Shoot Weight (g)	Fresh Root weight (g)	Dry Root Weight (g)	Total Seed Weight (g)	50 seeds weight (g)	Days to flowering
NERICA 1	Control	3.8	2.8	23.6	4.5	8.6	1.4	7.5	2.3	89.3
	<i>H. sacchari</i>	0.8	0.5	5.2	1.0	2.7	0.6	1.1	0.5	103.0
	<i>B. theobromae</i>	2.8	1.0	16.3	3.7	6.8	1.0	3.8	1.3	93.8
	H.s before B.t	0.3	0.0	3.6	0.7	1.4	0.3	0.0	0.0	dnf
	B.t before H.s	0.3	0.0	3.4	1.2	1.2	0.1	0.0	0.0	dnf
	H.s and B.t	0.0	0.0	3.4	1.0	1.3	0.1	0.0	0.0	dnf
NERICA 2	Control	4.0	3.0	21.4	5.2	12.1	2.0	6.1	3.1	90.3
	<i>H. sacchari</i>	1.8	1.0	8.4	1.3	3.6	0.5	1.2	0.7	107.0
	<i>B. theobromae</i>	3.8	2.0	20.4	4.6	10.7	1.4	5.8	2.2	87.5
	H.s before B.t	0.0	0.3	2.5	0.6	0.9	0.1	0.2	0.2	dnf
	B.t before H.s	0.0	0.3	1.5	0.3	0.6	0.1	0.0	0.0	dnf
	H.s and B.t	0.0	0.0	2.6	0.7	1.0	0.3	0.0	0.0	dnf
LSD (P≤0.05)		1.7	0.8	6.7	1.4	3.9	0.7	1.7	0.5	8.0

LSD for comparing treatment means within the same column. 5,000 *Heterodera sacchari* (H.s) eggs and second-stage juveniles (J<sub>2</sub>), 5X10<sup>5</sup> *Botryodiplodia theobromae* (B.t) spores, dnf = did not flower

The total seed weight of NERICA 1 rice infected with *B. theobromae* alone was significantly lower ( $P \leq 0.05$ ) than NERICA 2 rice infected with *B. theobromae* in total seed weight. Also, total seed weight of NERICA 1 and NERICA 2 rice infected with *H. sacchari* alone or in combination with *B. theobromae* were not significantly different from one another in the two trials (Tables 4.8 and 4.9). Furthermore, when both NERICA rice cultivars were infected with various combinations of nematode and fungus, the plants did not produce grains (Table 4.8). A similar observation was made in the second trial.

Similarly, the weight of 50 seeds of uninfected NERICA rice cultivars were not significantly different ( $P \leq 0.05$ ) from each other in the two trials. The weight of 50 seeds of NERICA 1 infected with *B. theobromae* alone was 1.2 g and NERICA 2 rice cultivar produced 1.1g for 50-seed weight although, the two cultivars were not significantly different ( $P \leq 0.05$ ) from each other (Table 4.8). A similar observation was made in the second trial. NERICA 1 rice inoculated with *H. sacchari* alone took 104 days to flower, earlier than NERICA 2 (107 days) although, not significantly different.

NERICA 1 rice inoculated with *B. theobromae* alone took 93.8 days to flower while NERICA 2 flowered earlier (90.3 days) than NERICA 1 (Table 4.8). Furthermore, NERICA rice plants infected with *H. sacchari* and *B. theobromae*, regardless of which organism came first did not flower till the end of the experiment (Table 4.8). However, the control plants in both cultivars took relatively fewer days to first flowering when compared with the infected plants in both trials (Tables 4.8 and 4.9).

Disease index and cyst production of infected NERICA 1 and NERICA 2 rice cultivars were not significantly different ( $P \leq 0.05$ ) from each other in both trials (Table 4.10). Similarly, total second-stage juveniles ( $J_2$ ) in pot recovered from the two infected NERICA rice cultivars were not significantly different ( $P \leq 0.05$ ) in the rice cultivars for the two trials. The total  $J_2$  recovered from NERICA 1 rice infected with *H. sacchari* alone and those inoculated with *H. sacchari* before *B. theobromae*, had more  $J_2$  in pot than NERICA 2 rice cultivar infected with *H. sacchari* alone and *H. sacchari* before *B. theobromae*, although, not significantly different ( $P \leq 0.05$ ) from each other one another (Table 4.10). A similar observation was made in the second trial.

**Table 4.10: Effects of interaction between *Heterodera sacchari* and *Botryodiplodia theobromae* on disease index and nematode reproduction on two NERICA rice cultivars**

Cultivar	Treatment	First trial					Second trial				
		*DI	**Cyst Prodn. rating	Total J <sub>2</sub> in pot (root +soil)	Total Cysts in pot (root +soil)	Number of eggs and J <sub>2</sub> /Cyst	*D I	**Cyst Prodn. rating	Total J <sub>2</sub> in pot (root +soil)	Total Cysts in pot (root +soil)	Number of eggs and J <sub>2</sub> /Cyst
NERICA 1	Control	0.0	0.0	0.0	0.0	0.0	0.0	0.0	0.0	0.0	0.0
	<i>H. sacchari</i>	3.8	4.0	11113.0	21025.0	355.0	4.0	4.0	16175.0	36700.0	355.0
	<i>B. theobromae</i>	1.8	0.0	0.0	0.0	0.0	2.0	0.0	0.0	0.0	0.0
	H.s before B.t	4.3	4.0	10100.0	20400.0	277.5	5.0	4.0	16213.0	18925.0	264.8
	B.t before H.s	3.5	4.0	9575.0	11963.0	263.5	4.0	4.0	9638.0	13450.0	278.8
	H.s and B.t	3.8	3.0	9388.0	12725.0	255.3	4.3	3.0	14394.0	12468.0	260.0
NERICA 2	Control	0.0	0.0	0.0	0.0	0.0	0.0	0.0	0.0	0.0	0.0
	<i>H. sacchari</i>	3.5	4.0	15013.0	16550.0	285.0	3.5	4.0	15345.0	38150.0	320.8
	<i>B. theobromae</i>	1.8	0.0	0.0	0.0	0.0	1.8	0.0	0.0	0.0	0.0
	H.s before B.t	4.0	4.0	12394.0	15700.0	272.3	4.3	4.0	9425.0	17175.0	275.0
	B.t before H.s	4.3	4.0	6425.0	10675.0	264.8	4.5	4.0	6600.0	11775.0	267.5
	H.s and B.t	4.0	4.0	5925.0	17178.0	266.3	4.3	3.0	4113.0	12928.0	275.3
LSD (P≤0.05)		1.1	0.8	11492.0	12270.0	51.3	1.0	1.1	11155.0	8003.1	54.2

LSD for comparing treatment means within the same column, \*Disease index (DI) where; 0 = No visible lesions, 1 = Lesions 1 mm long, light brown, 2 = Lesions 1 to 5mm long, brown, 3 = Lesions longer than 5mm, dark brown, 4 = Root totally infected and brown, 5 = Root totally destroyed and plant dying or dead. \*\*Cyst production: 0 = no cyst (Resistant); 1 = 1-2 cysts (Moderately Resistant); 2 = 3-10 cysts (Moderately Susceptible); 3= 11-30 cysts (Susceptible); 4 = 31 cysts and above (Highly susceptible). H.s = 5,000 *Heterodera sacchari* eggs and second-stage juveniles, B.t = 5X10<sup>5</sup> *Botryodiplodia theobromae* spores, J<sub>2</sub> = second-stage juveniles

Furthermore, total cyst and number of eggs and J<sub>2</sub> recovered in pot of NERICA 1 rice infected with *H. sacchari* alone was higher than NERICA 2 rice infected with *H. sacchari* alone, although, not significantly different (Table 4.10). Similar observation was made in the second trial.

#### **4.4.2: Interaction between *Heterodera sacchari* and *Botryodiplodia theobromae* on growth, yield and nematode reproduction on NERICA rice cultivars (Microplot)**

At four weeks after inoculation, NERICA rice cultivars inoculated with *H. sacchari* alone, *B. theobromae* alone or *H. sacchari* / *B.theobromae* inoculated at various sequential combinations, showed reduction in plant height, severe leaf chlorosis, poor tillering and poor plant vigour (Plate 4.2) compared with the control plant.

The mean plant height for various treatments obtained at four weeks after inoculation were not significantly different ( $P \leq 0.05$ ) from one another in both trials (Figs. 4.37a and 4.37b). Rice plants infected with *B. theobromae* alone and the control were not significantly different ( $P \leq 0.05$ ) from each other in height. *Botryodiplodia theobromae*-infected plants were not significantly different ( $P \leq 0.05$ ) from plants inoculated with the two pathogens while rice plants infected with *H. sacchari* alone and the two pathogens in various combinations were significantly shorter ( $P \leq 0.05$ ) in height than the control plant (Fig. 4.37). This was the observation until the end of the experiment in the two trials.

At six weeks after inoculation, leaf production in inoculated NERICA rice cultivars was not significantly different from the control plants in both trials. However, from the 8-11th weeks after inoculation, the control plants produced significantly higher ( $P \leq 0.05$ ) number of leaves than the infected NERICA rice cultivars (Figs 4.38a and 4.38b). This observation was made until the end of the experiment in the two trials. The leaf chlorophyll content of infected NERICA rice cultivars was not significantly different ( $P \leq 0.05$ ) from the control at two WAI and up to eight WAI in both trials (Figs. 4.39a and 4.39b). Rice plants infected with *H. sacchari* alone, *B. theobromae* alone or the two pathogens in various sequential combinations were statistically lower ( $P \leq 0.05$ ) in leaf chlorophyll content than the control, and this was observed at ten WAI in the first trial (Fig 4.39a), and eight WAI in the second trial (Fig. 4.39b).

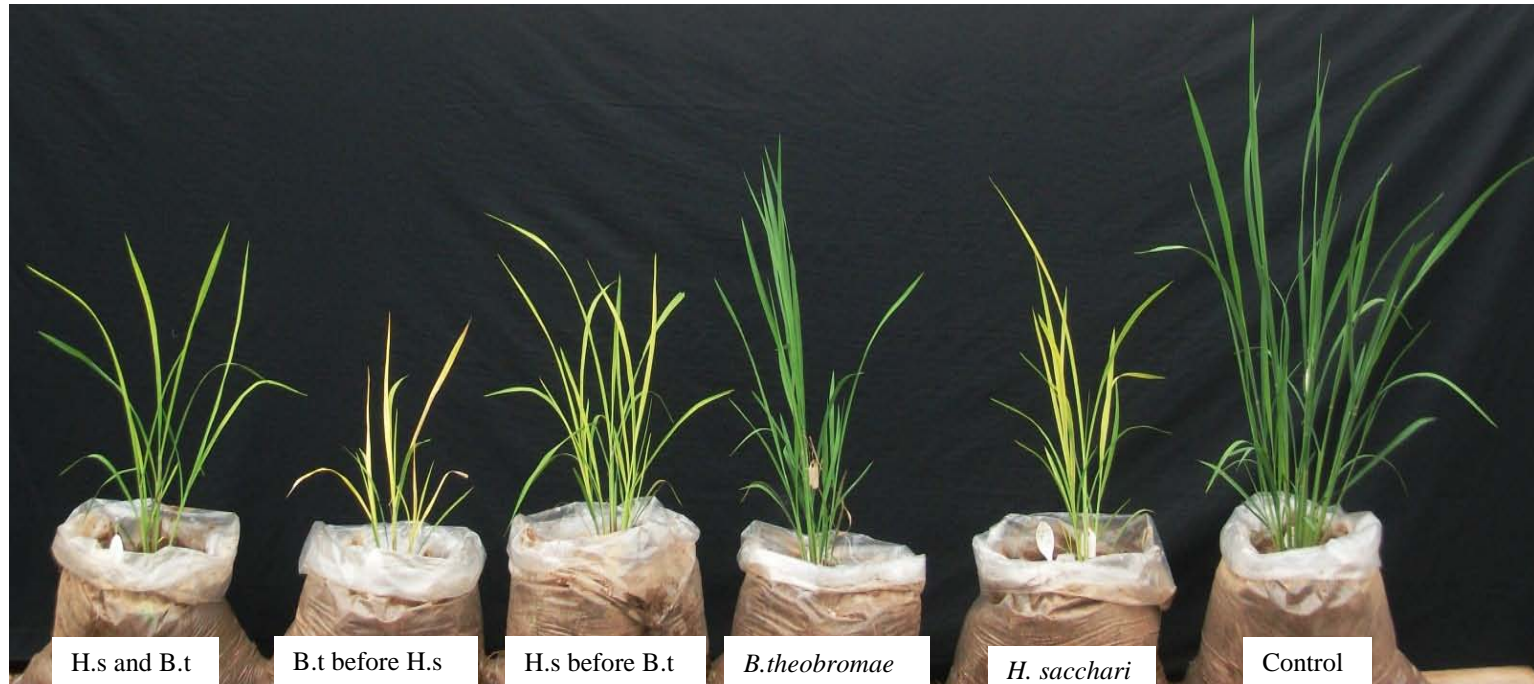

**Plate 4.2: Interaction between *Heterodera sacchari* and *Botryodiplodia theobromae* on NERICA 1 rice at four weeks after inoculation.** Inoculated plants showing poor growth, poor tillering and chlorotic leaves

Treatments = 50,000 *H.sacchari* (H.s) eggs and J<sub>2</sub> + 5.0X10<sup>6</sup> *B. theobromae* (B.t) spores inoculated simultaneously, 5.0X10<sup>6</sup> *B. theobromae* (B.t) spores + 50,000 *H. sacchari* (H.s) eggs and J<sub>2</sub> inoculated a week after the fungus, 50,000 *H. sacchari* (H.s) eggs and J<sub>2</sub> + 5.0X10<sup>6</sup> *B. theobromae* (B.t) spores inoculated a week after the nematode, 5.0X10<sup>6</sup> *B. theobromae* (B.t) spores, *H. sacchari* (H.s) eggs and second-stage juveniles (J<sub>2</sub>), Control (no nematode, no fungus)

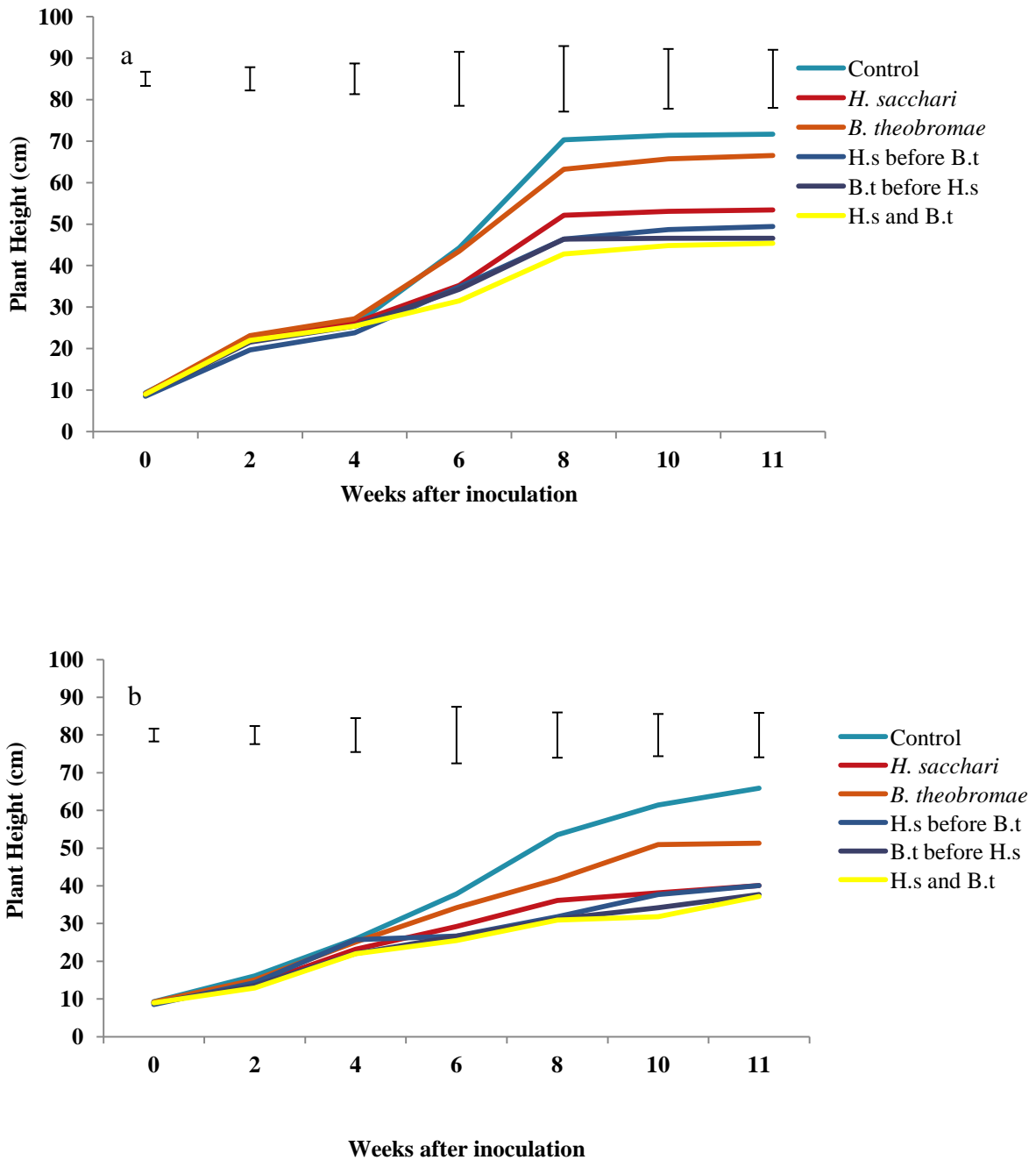

**Fig. 4.37: Effects of interaction between *Heterodera sacchari* and *Botryodiplodia theobromae* on height of two NERICA rice cultivars. a = first trial, b = second trial**

LSD bars for comparing means at each specific time, 50,000 *Heterodera sacchari* (H.s) eggs and second-stage juveniles (J<sub>2</sub>), 5.0X10<sup>6</sup> *Botryodiplodia theobromae* (B.t) spores.

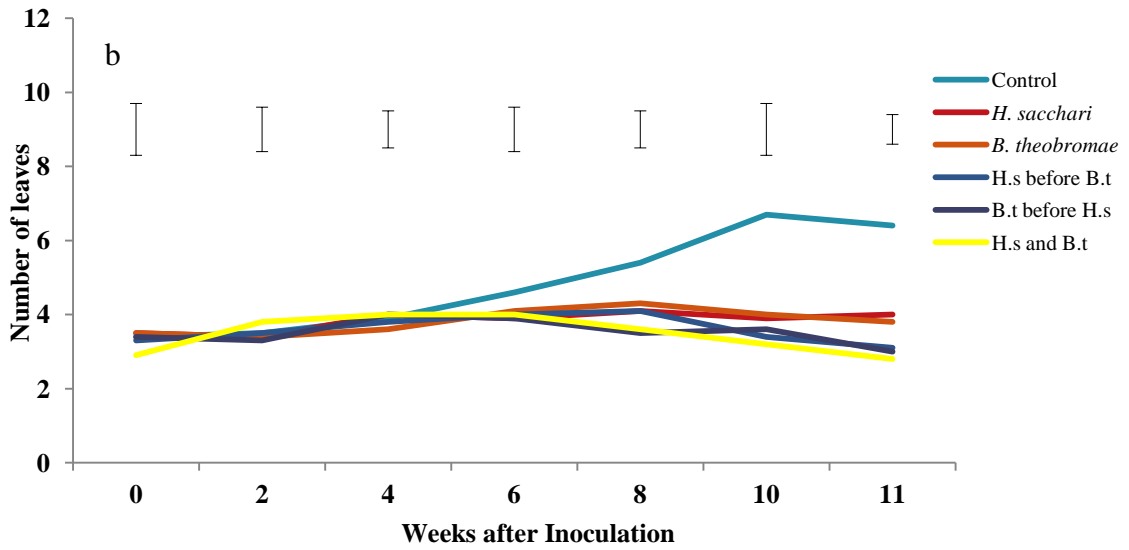
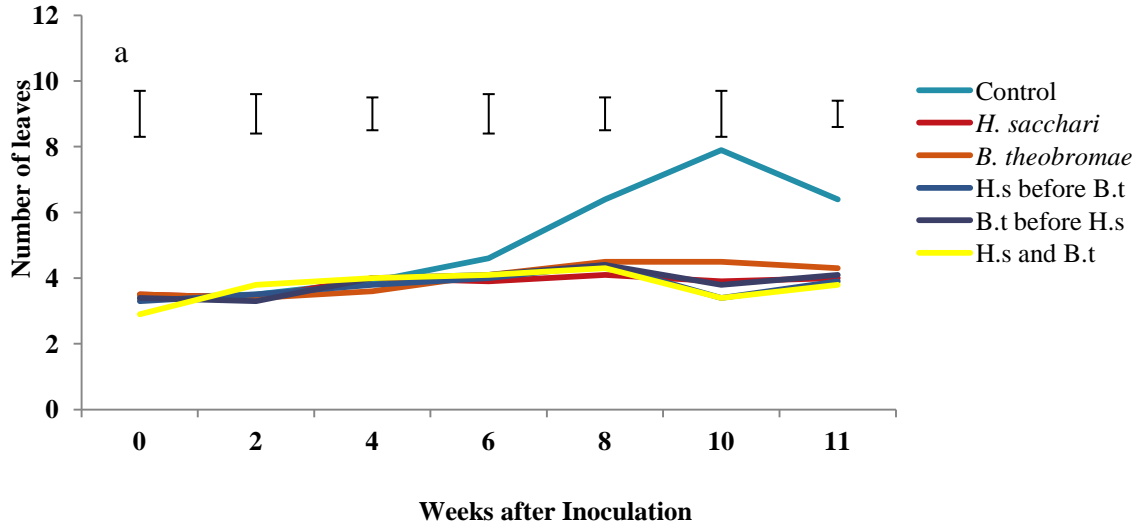

**Fig. 4.38: Effects of interaction between *Heterodera sacchari* and *Botryodiplodia theobromae* interaction on leaf production of two NERICA rice cultivars. a = first trial, b = second trial**

LSD bars for comparing means at each specific time, 50,000 *Heterodera sacchari* (H.s) eggs and second-stage juveniles ( $J_2$ ),  $5.0 \times 10^6$  *Botryodiplodia theobromae* (B.t) spores.



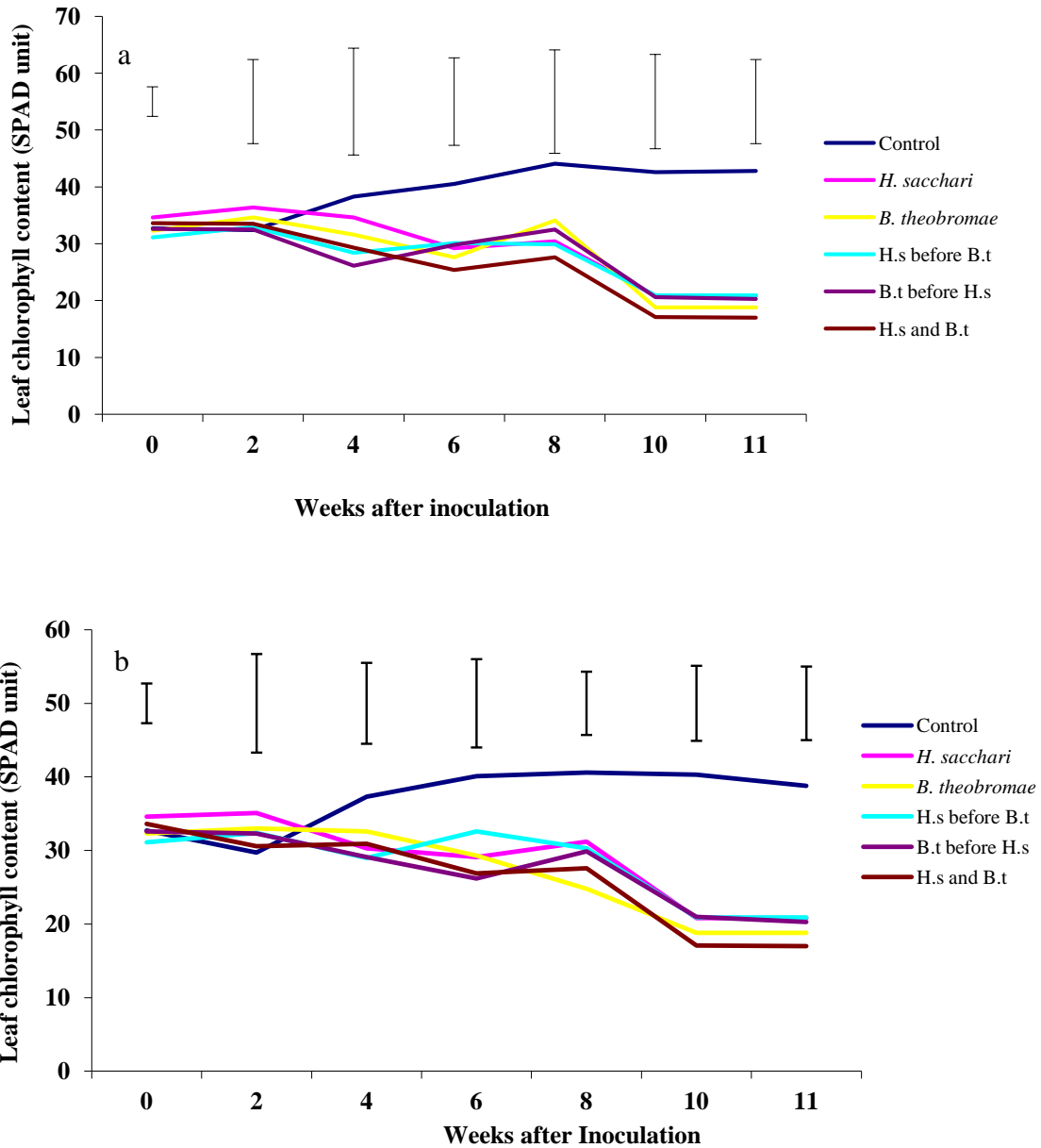

**Fig. 4.39: Effects of interaction between *Heterodera sacchari* and *Botryodiplodia theobromae* on leaf chlorophyll content of NERICA rice cultivars. a = first trial, b = second trial**

LSD bars for comparing means at each specific time, 50,000 *Heterodera sacchari* (H.s) eggs and second-stage juveniles ( $J_2$ ),  $5.0 \times 10^6$  *Botryodiplodia theobromae* (B.t) spores.

Furthermore, at ten weeks after inoculation, the uninfected rice plants recorded the highest leaf chlorophyll content of 42.6 while the leaf chlorophyll content of infected plants was between 17.1 and 20.9.

There were no significant differences ( $P \leq 0.05$ ) in the number of tillers, fresh shoot, dry shoot, fresh root and dry root weights of rice plants infected with *H. sacchari* alone, *B. theobromae* alone and *H. sacchari*-*B. theobromae* inoculated at various sequential combinations. Although, infected plants were significantly lower in the number of tillers produced, fresh and dry shoot weights, fresh and dry root weights than the uninfected plants (Table 4.11). In the second trial, number of tillers from plants inoculated with *H. sacchari* alone, *B. theobromae* alone were not significantly different from the control, although, fewer tillers were produced in the nematode alone infected plants and fungus alone infected plants (Table 4.11).

The rice plants inoculated with the two pathogens in various sequential combinations produced significantly fewer ( $P \leq 0.05$ ) numbers of tillers than the control and the *B. theobromae* alone infected plants in the second trial (Table 4.11). The number of panicles obtained from rice plants infected with the nematode, fungus or nematode-fungus inoculated together produced significantly fewer ( $P \leq 0.05$ ) number of panicles than the uninfected NERICA rice plants in the first trial (Table 4.11). Furthermore, there were no significant differences ( $P \leq 0.05$ ) in the number of panicles produced by the rice plants infected with the nematode, fungus or the two pathogens together, regardless of which one came in first (Table 4.11). In the second trial, rice plants infected with *H. sacchari* before *B. theobromae* produced significantly fewer number of panicles than the control although, not significantly different from other plants infected with nematode alone, fungus alone, fungus before the nematode and nematode-fungus together (Table 4.11).

Fresh shoot and dry shoot weights of NERICA rice cultivars were significantly lower ( $P \leq 0.05$ ) in plants infected with *H. sacchari* alone, *B. theobromae* alone or *H. sacchari*-*B. theobromae* inoculated in various sequential combinations ( $P \leq 0.05$ ) than the control in the first trial (Table 4.11). In the second trial, *B. theobromae* alone infected plants produced significantly heavier ( $P \leq 0.05$ ) fresh and dry shoot weights than the other infected treatments (Table 4.11).

**Table 4.11: Effects of interaction between *Heterodera sacchari* and *Botryodiplodia theobromae* on growth and yield of NERICA rice cultivars (microplots)**

Treatment	Number of Tillers	Number of Panicles	Fresh Shoot weight (g)	Dry Shoot Weight (g)	Fresh Root weight (g)	Dry Root Weight (g)	Total Seed Weight (g)	100 seeds weight (g)	Days to flowering
<b>First trial (2010)</b>									
Control	17.6	18.8	291.2	110.8	177.4	30.6	63.6	3.2	72.1
<i>H. sacchari</i>	12.4	7.4	104.3	34.1	53.9	6.9	26.9	2.6	83.3
<i>B. theobromae</i>	12.8	9.4	126.1	42.5	67.2	11.1	39.3	2.8	76.3
H.s before B.t	10.5	6.6	93.3	39.2	43.3	5.2	22.2	2.4	83.8
B.t before H.s	11.5	7.0	99.2	36.8	52.6	6.6	27.6	2.4	84.5
H.s and B.t	9.9	6.8	88.7	33.7	44.9	6.1	26.0	2.4	84.9
LSD (P≤0.05)	3.7	3.1	42.8	26.5	31.9	5.6	12.2	0.6	2.6
<b>Second trial (2011)</b>									
Control	10.9	7.9	185.8	55.6	115.4	22.5	25.5	3.5	68.9
<i>H. sacchari</i>	8.9	6.4	86.0	29.3	46.1	6.0	10.5	1.9	80.9
<i>B. theobromae</i>	10.9	6.3	128.5	47.3	86.5	17.8	12.7	2.0	76.6
H.s before B.t	8.6	4.3	99.4	32.2	57.7	8.0	9.1	1.8	86.3
B.t before H.s	7.9	5.8	97.5	33.2	54.6	8.6	6.1	1.5	85.4
H.s and B.t	7.6	5.6	67.2	22.3	41.9	6.1	4.8	1.6	86.9
LSD (P≤0.05)	2.3	2.7	28.8	12.0	27.1	4.6	6.4	0.8	3.2

LSD for comparing means in the same column. Control (no nematode, no fungus), 50,000 *H. sacchari* (H.s) eggs and second-stage juvenile (J<sub>2</sub>), 5.0X10<sup>6</sup> *B. theobromae* (B.t) spores, 50,000 H.s + 5X10<sup>6</sup> B.t spores inoculated a week after the nematode, 5.0X10<sup>6</sup> B.t spores + 50,000 H.s eggs and J<sub>2</sub> inoculated a week after the fungus, 5.0X10<sup>6</sup> B.t spores + 50,000 H.s eggs and J<sub>2</sub> inoculated simultaneously.

The root mass of rice plants infected with *H. sacchari* alone, *B. theobromae* alone or the two pathogens in various combinations was significantly reduced ( $P \leq 0.05$ ) than the uninfected plants at harvest (11 weeks after inoculation) (Plate 4.3). The infected plants had significantly lower ( $P \leq 0.05$ ) fresh and dry root weights than the uninfected plants in the two trials (Table 4.11). Rice plants infected with *B. theobromae* alone produced more roots than plants inoculated with *H. sacchari* alone, *H. sacchari* and *B. theobromae* together, although, not significantly different ( $P \leq 0.05$ ) from one another (Table 4.11). Similar observation was made in the second trial.

Total seed weight and 100-seed weight of infected NERICA rice plant was statistically lower ( $P \leq 0.05$ ) than the uninfected rice plants in both trials (Table 4.11). Furthermore, the weight of 100 seeds of the uninfected rice cultivars was 3.2g while the weight of infected plants was between 2.4 g to 2.8 g (Table 4.11). The plants infected with nematode alone took 83.3 days while the two pathogens together (83.8-84.9 days) took significantly ( $P \leq 0.05$ ) more days to flower than the fungus alone (76.3 days) inoculated plants and the control (72.1 days). Similar observation was made in the second trial (Table 4.11).

The disease index in plants inoculated with *H. sacchari*, *B. theobromae* and nematode-fungus in various combinations was significantly higher ( $P \leq 0.05$ ) compared with values for the uninoculated rice plants (Table 4.12). Cyst production was significantly higher ( $P \leq 0.05$ ) in rice plants infected with *H. sacchari* alone than the plants infected with *B. theobromae* before *H. sacchari*, *B. theobromae* alone, *H. sacchari*-*B. theobromae* inoculated simultaneously and the control in the first trial (Table 4.12). In the second trial, there were no significant differences ( $P \leq 0.05$ ) between the plants infected with *H. sacchari* alone and *H. sacchari*-*B. theobromae* inoculated in various combinations although, significantly different from the *B. theobromae* alone and the control (Table 4.12). Total second-stage juveniles ( $J_2$ ) in the uninoculated NERICA rice in microplots and *B. theobromae* alone inoculated rice were statistically different ( $P \leq 0.05$ ) from  $J_2$  recovered from microplots inoculated with *H. sacchari* and *B. theobromae* in various combinations (Table 4.12). Furthermore, NERICA rice inoculated with *H. sacchari* alone supported significantly higher second stage juvenile reproduction compared with various nematode-fungus combinations (Table 4.12).

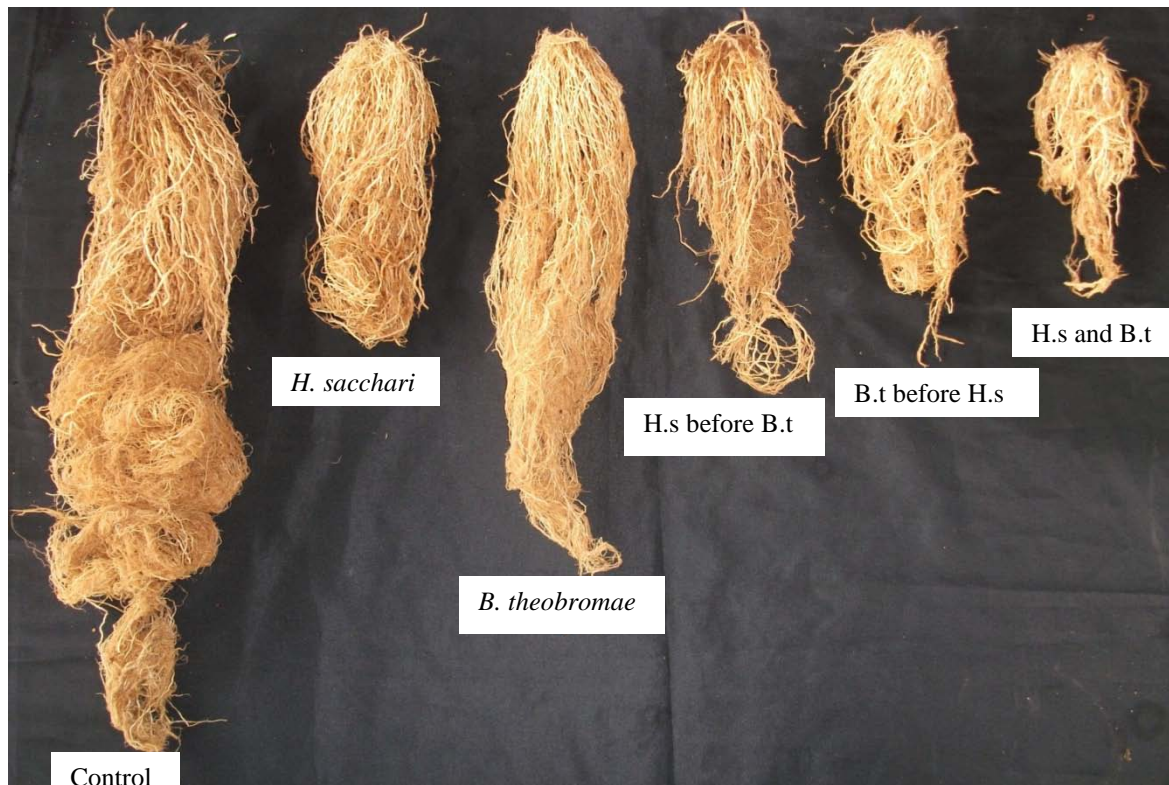

**Plate 4.3: Effects of interaction between *Heterodera sacchari* and *Botryodiplodia theobromae* on root mass of NERICA 1 rice at 11 weeks after inoculation.**

Treatments: Control (no nematode, no fungus)

50,000 *H. sacchari* (H.s) eggs and second-stage juveniles (J<sub>2</sub>) alone

$5.0 \times 10^6$  *B. theobromae* (B.t) spores alone

50000 *H. sacchari* (H.s) eggs and J<sub>2</sub> +  $5.0 \times 10^6$  *B. theobromae* (B.t) spores inoculated a week after the nematode

$5.0 \times 10^6$  *B. theobromae* (B.t) spores + 50,000 *H. sacchari* (H.s) eggs and J<sub>2</sub> inoculated a week after the fungus

50000 *H. sacchari* (H.s) eggs and J<sub>2</sub> +  $5.0 \times 10^6$  *B. theobromae* (B.t) spores inoculated simultaneously

**Table 4.12: Effects of interaction between *Heterodera sacchari* and *Botryodiplodia theobromae* on disease index and nematode reproduction on NERICA rice cultivars in microplot**

Treatment	*DI	**Cyst Prodn. rating	J <sub>2</sub> in 250 ml of Soil	Total J <sub>2</sub> Root	Total J <sub>2</sub> in soil	Total J <sub>2</sub> in microplot	Number of Cysts in 250 ml	Total Cysts in Soil	Total Cysts on Root	Total Cysts in microplot	Number eggs and J <sub>2</sub> /Cyst
<b>First trial (2010)</b>											
Control	0.0	0.0	0.0	0.0	0.0	0.0	0.0	0.0	0.0	0.0	0.0
<i>H. sacchari</i>	3.6	4.0	218.8	399938.0	43750.0	83688.0	875.0	175000.0	9513.0	184513.0	280.9
<i>B. theobromae</i>	1.4	0.0	0.0	0.0	0.0	0.0	0.0	0.0	0.0	0.0	0.0
H.s before B.t	4.1	3.9	156.2	26125.0	31250.0	57375.0	687.5	137500.0	6963.0	144463.0	272.0
B.t before H.s	4.0	3.5	230.0	23038.0	46000.0	69038.0	262.5	52500.0	4744.0	57244.0	265.6
H.s and B.t	4.1	3.6	131.3	30075.0	26350.0	60688.0	356.3	71250.0	6095.0	77345.0	269.8
LSD (P≤0.05)	0.7	0.4	88.5	18754.0	17697.0	19173.0	244.0	48797.0	5723.0	51104.0	22.8
<b>Second trial (2011)</b>											
Control	0.0	0.0	0.0	0.0	0.0	0.0	0.0	0.0	0.0	0.0	0.0
<i>H. sacchari</i>	3.6	4.0	162.5	14763.0	32500.0	47263.0	900.0	180000.0	4013.0	184013.0	294.8
<i>B. theobromae</i>	1.5	0.0	0.0	0.0	0.0	0.0	0.0	0.0	0.0	0.0	0.0
H.s before B.t	3.8	4.0	187.5	20200.0	37500.0	57700.0	887.5	177500.0	3250.0	180750.0	344.4
B.t before H.s	4.4	4.0	175.0	16375.0	35000.0	51375.0	700.0	140000.0	4513.0	144513.0	321.4
H.s and B.t	4.3	4.0	112.5	17700.0	22500.0	40200.0	812.5	162500.0	5775.0	168275.0	355.4
LSD (P≤0.05)	0.7	2.1	90.8	7113.0	18166.0	19706.0	417.6	83523.0	2980.2	84851.0	56.4

LSD for comparing means in the same column, \*Disease index (DI) where; 0 = No visible lesions, 1 = Lesions 1 mm long, light brown, 2 = Lesions 1 to 5mm long, brown, 3 = Lesions longer than 5mm, dark brown, 4 = Root totally infected and brown, 5 = Root totally destroyed and plant dying or dead. \*\*Cyst production rating: 0 = no cyst (Resistant); 1 = 1-2 cysts (Moderately Resistant); 2 = 3-10 cysts (Moderately Susceptible); 3= 11-30 cysts (Susceptible); 4 = 31 cysts and above (Highly susceptible). Control (no nematode, no fungus), 50,000 *H. sacchari* (H.s) eggs and second-stage juveniles,  $5 \times 10^6$  *B. theobromae* (B.t) spores, 50,000 H.s +  $5 \times 10^6$  B.t spores inoculated a week after the nematode,  $5 \times 10^6$  B.t spores + 50,000 H.s eggs and J<sub>2</sub> inoculated a week after the fungus,  $5 \times 10^6$  B.t spores + 50,000 H.s eggs and J<sub>2</sub> inoculated simultaneously, J<sub>2</sub> = second-stage juveniles

Total number of cysts in microplots and number of eggs and second-stage juveniles (J<sub>2</sub>) per cyst of plants inoculated with either *H. sacchari* alone or in combination with *B. theobromae* were significantly higher than the control and *B. theobromae* alone inoculated NERICA rice plants (Table 4.12). Rice plants infected with *H. sacchari* alone had the highest number of cysts and number of eggs and J<sub>2</sub> per cyst (Table 4.12). These observations were also made in the second trial.

#### **4.4.3: Response of NERICA 1 and NERICA 2 rice cultivars to the interaction between *Heterodera sacchari* and *Botryodiplodia theobromae* at 11 weeks after inoculation (harvest) in the microplot**

At harvest, the height of the two NERICA rice cultivars, showed similar response to nematode-fungus inoculation in the two trials. NERICA 1 infected with *B. theobromae* alone, *H. sacchari* before the fungus, and *H. sacchari*-*B. theobromae* were taller than NERICA 2 rice infected in similar order, although, there were no significant differences ( $P \leq 0.05$ ) in height of the two rice cultivars (Fig. 4.40). In the second trial, NERICA 2 rice infected with *H. sacchari* alone, *B. theobromae* alone, and nematode-fungus inoculated at various sequential combinations were taller than NERICA 1 infected in similar order, although there were no significant differences ( $P \leq 0.05$ ) in height of the two NERICA cultivars (Fig. 4.40b).

At eleven weeks after inoculation, infected NERICA 1 and NERICA 2 rice plants had similar pattern of leaf production however, there were no significant differences ( $P \leq 0.05$ ) in number of leaves produced by the two cultivars in both trials (Fig. 4.41). The *B. theobromae* alone infected NERICA 1 plants produced significantly higher ( $P \leq 0.05$ ) number of leaves than NERICA 2 infected with the two pathogens in the first trial (Fig. 4.41a). In the second trial, there were no significant differences ( $P \leq 0.05$ ) between the two NERICA rice cultivars infected with the organisms singly or when the two pathogens were inoculated together (Fig. 4.41b).

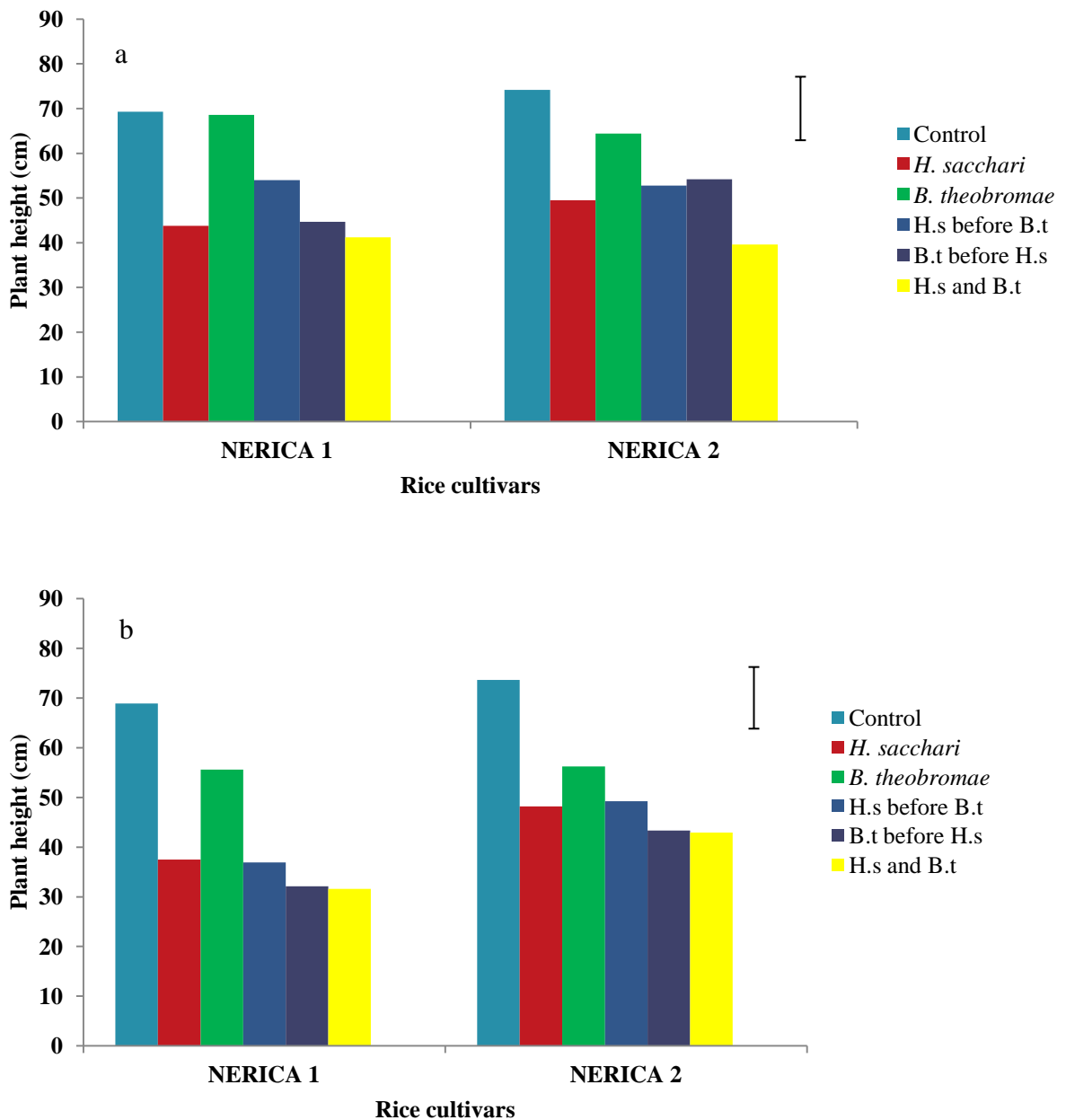

**Fig. 4.40: Effects of interaction between *Heterodera sacchari* and *Botryodiplodia theobromae* on height of NERICA 1 and NERICA 2 rice cultivars at eleven weeks after planting. a = first trial, b = second trial.**

LSD bar is for comparing treatment means across cultivars, Control (no nematode, no fungus), 50000 *H. sacchari* (H.s) eggs and second-stage juveniles ( $J_2$ ),  $5.0 \times 10^6$  *B. theobromae* (B.t) spores, 50000 H.s +  $5.0 \times 10^6$  B.t spores inoculated a week after the nematode,  $5.0 \times 10^6$  B.t spores + 50,000 H.s eggs and  $J_2$  inoculated a week after the fungus,  $5.0 \times 10^6$  B.t spores + 50000 H.s eggs and  $J_2$  inoculated simultaneously.



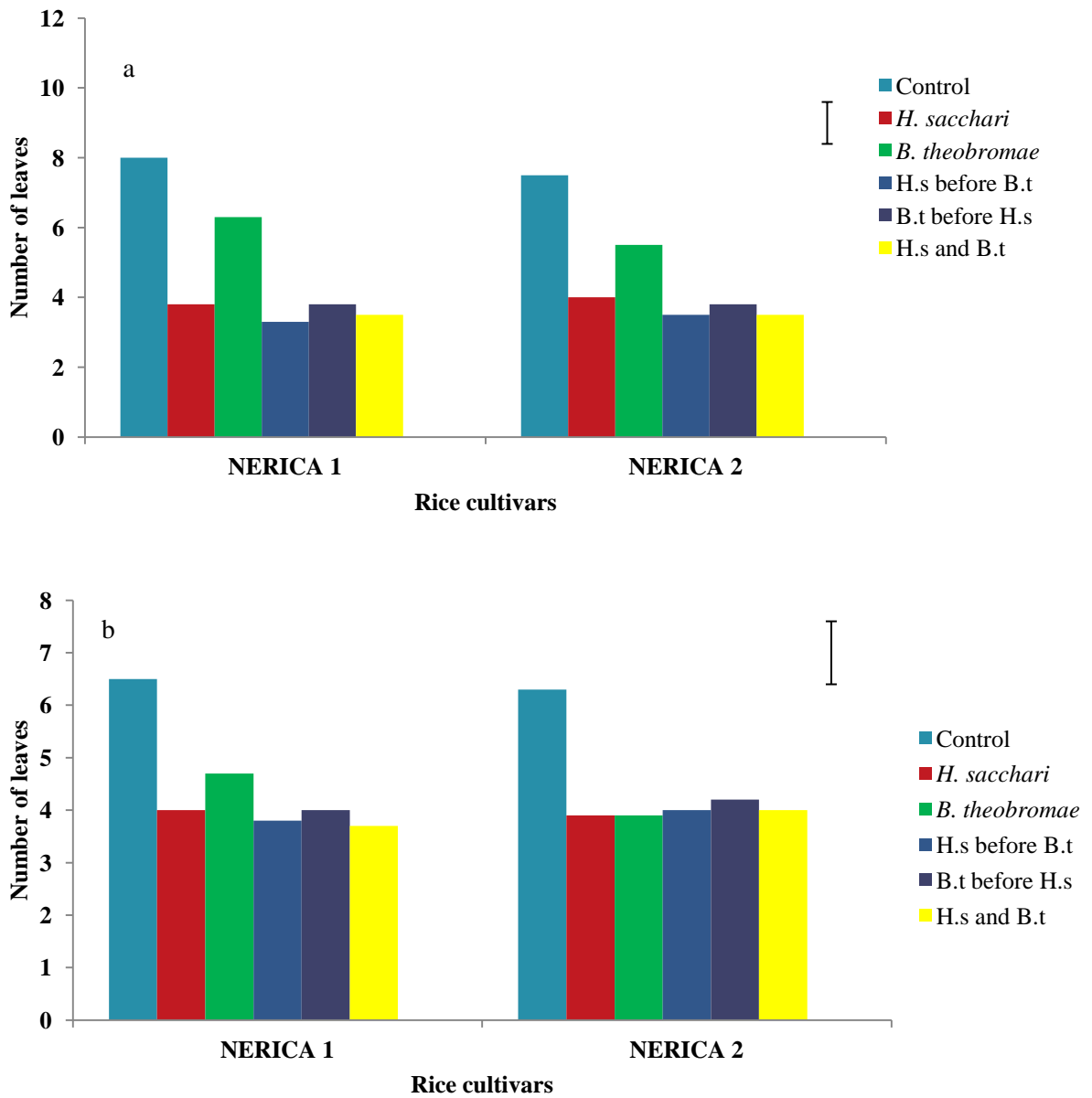

**Fig. 4.41: Effects of interaction between *Heterodera sacchari* and *Botryodiplodia theobromae* on leaf production of NERICA 1 and NERICA 2 rice cultivars at eleven weeks after planting. a = first trial, b= second trial**

LSD bar is for comparing treatment means across cultivars. Control (no nematode, no fungus), 50000 *H. sacchari* (H.s) eggs and second-stage juveniles (J<sub>2</sub>), 5.0X10<sup>6</sup> *B. theobromae* (B.t) spores, 50000 H.s + 5.0X10<sup>6</sup> B.t spores inoculated a week after the nematode, 5.0X10<sup>6</sup> B.t spores + 50,000 H.s eggs and J<sub>2</sub> inoculated a week after the fungus, 5.0X10<sup>6</sup> B.t spores + 50000 H.s eggs and J<sub>2</sub> inoculated simultaneously.

The mean leaf chlorophyll contents of uninfected NERICA 1 and NERICA 2 rice cultivars were significantly higher than the NERICA rice cultivars infected with nematode alone, fungus alone, and nematode-fungus in various inoculation sequences regardless of which of the organisms came in first in both trials (Fig. 4.42). The uninfected NERICA 2 rice produced higher number of tillers than the uninfected NERICA 1 rice cultivar although, there was no significant difference ( $P \leq 0.05$ ) in the number of tillers produced from each other, and *H. sacchari* alone infected plants in the first trial (Table 4.13). Furthermore, NERICA 2 rice infected with *H. sacchari* alone, *B. theobromae* alone, *H. sacchari* before *B. theobromae*, *B. theobromae* before the nematode, and the two pathogens inoculated together produced higher number of tillers than NERICA 1 rice infected with the organisms in similar order, although, there were no significant differences (Table 4.13). Similar observation was made in the second trial.

The number of panicles produced by uninfected NERICA 2 rice cultivar was significantly higher ( $P \leq 0.05$ ) than those produced by uninfected NERICA 1 in the two trials (Table 4.13). NERICA 2 rice infected with *H. sacchari* alone, *B. theobromae* alone and the two pathogens inoculated with the two organisms in various sequential combinations produced more panicles than the infected NERICA 1 rice cultivars in the two trials although, there were no significant differences in the number of panicles produced (Table 4.13). The lowest number of panicles (4.8 panicles) was produced by NERICA 1 rice infected with *H. sacchari* before *B. theobromae* infection while the highest panicle number was recorded for uninoculated NERICA 2 rice cultivar (24.5 panicles) in the first trial (Table 4.13).

The infected NERICA 1 rice plants had higher fresh and dry shoot weights than the fresh and dry shoot weight obtained for infected NERICA 2 rice cultivar in the first trial although, there were no significant differences. In the second trial, similar observations were made (Table 4.13). The fresh and dry root weights of infected NERICA 1 rice plants were higher ( $P \leq 0.05$ ) than NERICA 2 rice plants infected with *H. sacchari* alone, *B. theobromae* alone and the two pathogens inoculated at various sequential combinations although, there were no significant differences ( $P \leq 0.05$ ) in the two NERICA rice for fresh and dry root weights in the first trial (Table 4.13). Similar observations were made in the second trial.

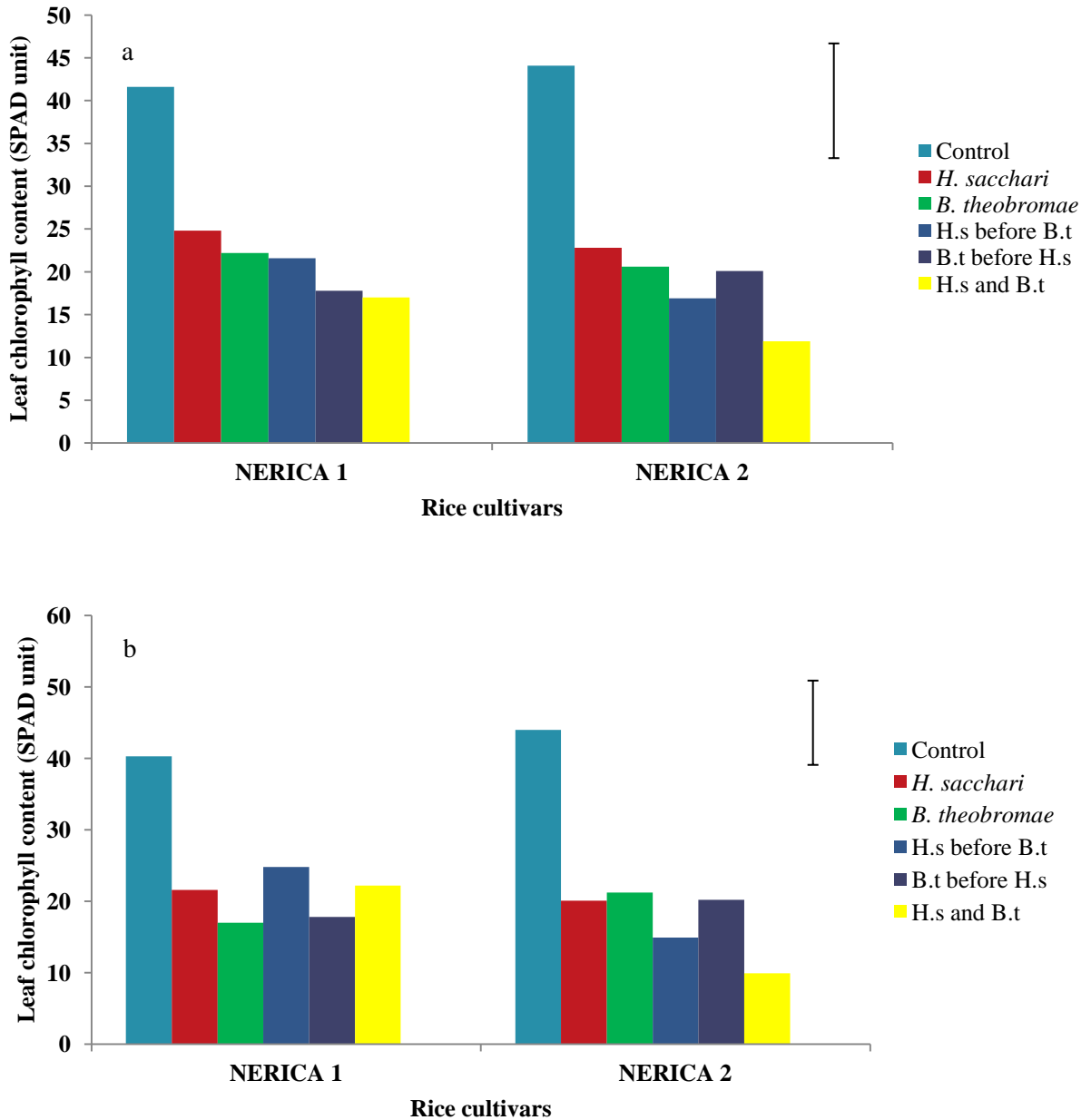

**Fig. 4.42: Effects of interaction between *Heterodera sacchari* and *Botryodiplodia theobromae* on leaf chlorophyll content of NERICA 1 and NERICA 2 rice cultivars at eleven weeks after planting. a= first trial, b = second trial**

LSD bar is for comparing treatment means across cultivars, Control (no nematode, no fungus), 50000 *H. sacchari* (H.s) eggs and second-stage juveniles ( $J_2$ ),  $5.0 \times 10^6$  *B. theobromae* (B.t) spores, 50000 H.s +  $5.0 \times 10^6$  B.t spores inoculated a week after the nematode,  $5.0 \times 10^6$  B.t spores + 50,000 H.s eggs and  $J_2$  inoculated a week after the fungus,  $5.0 \times 10^6$  B.t spores + 50000 H.s eggs and  $J_2$  inoculated simultaneously.

**Table 4.13: Effects of interaction between *Heterodera sacchari* and *Botryodiplodia theobromae* on growth and yield parameters of NERICA 1 and NERICA 2 rice cultivars**

Cultivar	Treatment	Number of Tillers	Number of Panicles	Fresh Shoot weight (g)	Dry Shoot Weight (g)	Fresh Root weight (g)	Dry Root Weight (g)	Total Seed Weight (g)	Weight of 100 seeds (g)	Days to flower
<b>First trial (2010)</b>										
NERICA 1	Control	17.0	14.0	241.5	80.3	139.5	18.9	61.9	3.4	71.8
NERICA 2	Control	18.3	24.5	340.9	141.4	215.2	42.3	65.3	3.3	72.5
NERICA 1	<i>H. sacchari</i>	11.0	6.3	125.8	37.2	67.2	8.7	27.7	2.8	81.5
NERICA 2	<i>H. sacchari</i>	13.8	8.5	82.7	31.0	40.6	4.6	36.7	2.6	83.3
NERICA 1	<i>B. theobromae</i>	12.3	9.3	148.1	50.3	77.6	12.9	37.0	2.8	76.5
NERICA 2	<i>B. theobromae</i>	13.3	9.5	104.2	34.8	56.8	9.4	41.5	2.8	77.0
NERICA 1	H.s before B.t	10.0	4.8	109.0	51.3	46.5	5.4	18.6	2.2	84.3
NERICA 2	H.s before B.t	11.0	8.5	77.7	34.6	40.2	5.0	25.5	2.4	85.0
NERICA 1	B.t before H.s	10.8	5.3	109.2	39.0	50.9	6.2	25.1	2.0	85.8
NERICA 2	B.t before H.s	12.3	8.8	89.1	34.6	54.3	7.5	26.1	2.4	83.3
NERICA 1	H.s and B.t	8.3	7.3	107.3	39.2	51.4	7.7	17.8	1.8	84.0
NERICA 2	H.s and B.t	11.5	6.3	70.1	28.2	38.5	4.6	18.8	2.4	85.8
LSD (P≤0.05)		4.8	4.1	52.3	30.3	35.8	6.5	16.0	0.8	3.9
<b>Second trial (2011)</b>										
NERICA 1	Control	11.8	7.8	201.2	56.4	137.0	26.3	22.7	3.3	67.3
NERICA 2	Control	10.0	8.5	170.4	54.8	93.3	18.8	28.3	3.8	70.5
NERICA 1	<i>H. sacchari</i>	9.5	5.3	109.0	37.3	57.6	7.3	5.9	1.3	81.5
NERICA 2	<i>H. sacchari</i>	8.3	3.3	63.0	21.2	34.6	4.7	12.3	1.7	80.3
NERICA 1	<i>B. theobromae</i>	10.0	7.3	145.1	50.9	93.9	19.8	10.3	1.7	76.5
NERICA 2	<i>B. theobromae</i>	11.8	8.0	111.8	43.6	79.1	15.9	15.2	2.2	76.8
NERICA 1	H.s before B.t	8.3	4.3	93.0	29.6	54.7	7.2	6.4	1.6	86.5
NERICA 2	H.s before B.t	9.0	5.3	105.8	34.9	60.7	8.8	11.9	2.1	86.0
NERICA 1	B.t before H.s	7.5	5.5	107.8	35.2	66.1	10.2	6.3	1.4	86.3
NERICA 2	B.t before H.s	8.3	6.0	87.2	31.2	43.2	7.1	8.7	2.4	84.5
NERICA 1	H.s and B.t	7.3	5.5	61.5	21.5	32.9	5.0	3.6	1.1	86.5
NERICA 2	H.s and B.t	8.0	5.8	72.8	23.1	50.9	7.1	6.0	2.1	87.3
LSD (P≤0.05)		3.3	4.0	42.0	15.5	34.1	7.5	9.7	1.0	3.9

LSD for comparing means in the same column. Control (no nematode, no fungus), 50,000 *H. sacchari* (H.s) eggs and second-stage juveniles (J<sub>2</sub>), 5.0X10<sup>6</sup> *B. theobromae* (B.t) spores, 50,000 H.s + 5.0X10<sup>6</sup> B.t spores inoculated a week after the nematode, 5.0X10<sup>6</sup> B.t spores + 50,000 H.s eggs and J<sub>2</sub> inoculated a week after the fungus, 5.0X10<sup>6</sup> B.t spores + 50000 H.s eggs and J<sub>2</sub> inoculated simultaneously.

The total seed weight of infected NERICA 2 rice cultivar was higher than the total seed weight of infected NERICA 1 rice plants inoculated with the nematode alone, fungus alone and nematode-fungus inoculated in various combinations in the two trials (Table 4.13). Although, not significantly different from one another ( $P \leq 0.05$ ) Uninfected NERICA 2 rice cultivar had the highest total seed weight of 65.3 g which was closely followed by uninfected NERICA 1 rice (61.9 g) while the lowest total seed weight was recorded for NERICA 1 rice cultivar infected with nematode and fungus simultaneously (17.8 g) (Table 4.13). Similar observation was made in the second trial. There were no significant differences ( $P \leq 0.05$ ) in 100-seed weight of NERICA 1 and NERICA 2 rice plants infected with the nematode alone, fungus alone and the two pathogens inoculated together in various sequential combinations in the two trials (Table 4.13). Infected NERICA rice cultivars took significantly ( $P \leq 0.05$ ) longer time (days) to flower compared with the control plants of NERICA 1 and NERICA 2, respectively in both trials (Table 4.13). The number of days to flower taken by infected NERICA 1 rice cultivar was between 76.5 days to 85.8 days while in the infected NERICA 2 cultivar, days to first flowering was between 77.0 days to 85.8 days, respectively (Table 4.13). Meanwhile, the control plants took 71.8 to 72.5 days to flower in both NERICA rice cultivars (Table 4.13). Similar observation was made in the second trial.

Disease index and cyst production rating in the uninfected NERICA rice cultivars was statistically lower ( $P \leq 0.05$ ) than those of the infected NERICA rice cultivars in both trials (Table 4.14). Total  $J_2$  production in NERICA 1 inoculated with *H. sacchari* alone or with the fungus in various combinations ranged from 54,650.0 juveniles to 84,075.0 juveniles in the microplot (Table 4.14). Similarly, infected NERICA 2 rice cultivars had a mean population of total second-stage juveniles which ranged from 59,675.0 juveniles to 83,300.0 juveniles when compared with the uninfected NERICA 2 rice cultivar with a significantly lower ( $P \leq 0.05$ )  $J_2$  population of 0.0  $J_2$  (Table 4.14). Total cyst production of both cultivars was significantly higher in plants infected with *H. sacchari* alone, *H. sacchari* plus *B. theobromae* a week after nematode inoculation and *B. theobromae* plus *H. sacchari* simultaneous inoculation when compared with the control (Table 4.14).

**Table 4.14: Effects of interaction between *Heterodera sacchari* and *Botryodiplodia theobromae* on disease index and nematode reproduction on NERICA 1 and NERICA 2 rice cultivars**

Cultivar	Treatment	First trial					Second trial				
		*D I	**Cyst Prodn. rating	Total J <sub>2</sub> in microplot (root + soil)	Total cysts in microplot (root + soil)	Number of eggs and J <sub>2</sub> /cyst	*D I	**Cyst Prodn. rating 0-4	Total J <sub>2</sub> in microplot (root + soil)	Total cysts in microplot (root + soil)	Number of eggs and J <sub>2</sub> /cyst
NERICA 1	Control	0.0	0.0	0.0	0.0	0.0	0.0	0.0	0.0	0.0	0.0
	<i>H. sacchari</i>	3.8	3.8	84075.0	193950.0	286.3	3.5	4.0	56300.0	159150.0	293.5
	<i>B. theobromae</i>	1.0	0.0	0.0	0.0	0.0	1.8	0.0	0.0	0.0	0.0
	H.s before B.t	4.3	4.0	76800.0	166000.0	269.5	3.8	4.0	47600.0	107150.0	377.3
	B.t before H.s	3.8	4.0	54650.0	79450.0	266.0	4.5	4.0	54925.0	185700.0	265.0
	H.s and B.t	3.8	3.8	61700.0	81525.0	249.9	4.3	4.0	33575.0	129550.0	384.5
NERICA 2	Control	0.0	0.0	0.0	0.0	0.0	0.0	0.0	0.0	0.0	0.0
	<i>H. sacchari</i>	3.5	3.3	83300.0	175075.0	289.8	3.8	4.0	38225.0	208875.0	296.0
	<i>B. theobromae</i>	1.8	0.0	0.0	0.0	0.0	1.3	0.0	0.0	0.0	0.0
	H.s before B.t	4.0	3.8	61275.0	122925.0	274.5	3.8	4.0	67800.0	254350.0	311.5
	B.t before H.s	4.3	4.0	60100.0	35038.0	265.3	4.3	4.0	47825.0	103325.0	377.8
	H.s and B.t	4.5	3.5	59675.0	73165.0	275.5	4.3	4.0	46825.0	207000.0	326.3
LSD (P≤0.05)		0.9	0.5	32919.0	27213.0	28.7	1.0	0.0	26177.0	139053.0	88.9

LSD for comparing means in the same column, \*Disease index (DI) where; 0 = No visible lesions, 1 = Lesions 1 mm long, light brown, 2 = Lesions 1 to 5mm long, brown, 3 = Lesions longer than 5mm, dark brown, 4 = Root totally infected and brown, 5 = Root totally destroyed and plant dying or dead. \*\*Cyst production rating: 0 = no cyst (Resistant); 1 = 1-2 cysts (Moderately Resistant); 2 = 3-10 cysts (Moderately Susceptible); 3= 11-30 cysts (Susceptible); 4 = 31 cysts and above (Highly susceptible). Control (no nematode, no fungus), 50,000 *H. sacchari* (H.s) eggs and second-stage juveniles (J<sub>2</sub>), 5.0X10<sup>6</sup> *B. theobromae* (B.t) spores, 50,000 H.s + 5.0X10<sup>6</sup> B.t spores inoculated a week after the nematode, 5.0X10<sup>6</sup> B.t spores + 50,000 H.s eggs and J<sub>2</sub> inoculated a week after the fungus, 5.0X10<sup>6</sup> B.t spores + 50,000 H.s eggs and J<sub>2</sub> inoculated simultaneously.

The number of eggs and second-stage juveniles per cyst ranged from 249.9 to 286.3 in NERICA 1 rice cultivar while in the NERICA 2 rice cultivar, number of eggs and juveniles ranged from 265.3 to 289.8 per cyst (Table 4.14) when compared with the controls and *B. theobroma* alone inoculated plants in both rice cultivars (Table 4.14). Similar was observed in the second trial.

#### **4.5 Host-parasite relations of *H. sacchari* in NERICA 1 rice cultivar**

Longitudinal and transverse sections of uninoculated rice root revealed the anatomical structures typical of monocotyledonous plants (Plates 4.4a and 4.4b). Examination of roots stained with acid fuchsin in lactoglycerol at 48 hours after inoculation revealed that the second-stage juvenile ( $J_2$ ) had penetrated the root (Plate 4.4c). A longitudinal section of the root at the meristematic zone revealed that the  $J_2$  moved intercellularly within the root cortex until it reached the vascular tissues at 96 hours after inoculation, (Plate 4.4d). There was little or no visible damage observed in the root cells invaded by *H. sacchari* second-stage larvae at this stage. Sections of rice roots at seven days after inoculation (DAI) revealed the presence of an enlarged  $J_2$  with stomodeum completely embedded in a well-established syncytium induced by the nematode which are multinucleate and contained dense cytoplasm (Plates 4.4.1e, 4.4.1f and 4.4.1g). The number of syncytia that were observed near the head of each nematode ranged from two to seven. The root cells surrounding the nematodes were usually compressed and disorganized creating cavity around the nematode. The fourth-stage juvenile was observed in the roots 14 DAI (Plate 4.4.1h). Longitudinal sections of the roots revealed that the nematode body wall had thickened and the contents inside the nematode body were granular. The cortical cells and some epidermal cells were necrotic. It was also noted that the nematode increased in size as the diameter of the infected roots increased. Comparative histological observation of healthy (Plates 4.4a and 4.4b) and infected roots showed cellular disorganization in the cortex, endodermis and vascular cells. The fourth-stage juvenile had increased in size with the body oriented along the root axis by the 19th day of inoculation (Plates 4.4.2i and 4.4.2j). Severe necrosis and highly compressed cortical and endodermal cells had occurred at this stage. Syncytium formed at the head region of nematode modified vascular elements and had considerable thickened cytoplasmic contents. At twenty one DAI, the root sections

showed considerable collapse and disintegration of the epidermal layer, as well as those of the cortical and endodermal cells (Plates 4.4.2k and 4.4.2l). In addition, transverse sections of infected rice root revealed the pericycle, xylem and phloem tissues were extensively damaged by the nematode similarly, the pith cells were also disorganised and damaged by the nematode. Twenty four days after inoculation (DAI), severe root cracks occurred along the root axis and white, mature females emerged from the cracks (Plates 4.4.3m and 4.4.3n). Some of the mature females had developed with large quantities of eggs. Body wall colour changes in females occurred at day 29 after inoculation and brown cysts with viable eggs were also observed (Plates 4.4o and 4.4p). Extensive destruction of roots occurred at the root tips and along the roots where the females emerged. The head region of the nematodes remained embedded in the root tissues, while the anal region was exposed outside the root.

#### **4.6 Histopathology details of NERICA 1 rice root infected with *H. sacchari* and *B. theobromae***

Longitudinal section of the root structure of rice infected with *B. theobromae* alone revealed that matured ascospores of the fungus had attached to the epidermal layer of infected NERICA 1 rice root at 24 hours after inoculation. Probably, the ascospores were secreting enzymes to soften the surface of the epidermal layer prior to the development of the appressorium that would penetrate into the host cells (Plate 4.5a), although, there was no visible damage to cell structure at this stage and the development of appressorium could not be monitored subsequently. At seven days after inoculation (DAI), the fruiting body (ascocarp) had absorbed water from the surrounding cortical cells which caused an increased turgor pressure and explosive release of ascospores as a result breaking the epidermal layer of the rice root (Plate 4.5b). Sections of root harvested 11 days after infection revealed large necrotic regions where the *B. theobromae* ascospores were released (Plate 4.5c). Sections of the roots at 17 DAI revealed an enlarged *B. theobromae* fruiting body which had compressed all the root cells around the cortex ahead of explosion to release ascospores through the broken epidermal layer (Plate 4.5d) as a result, the epidermal layer and the root cortex was exposed and space occupied by the fruiting body became necrotic (Plate 4.5e). By 20 days after *B. theobromae* infection, a necrotic cavity was observed which was created as a result of the rupture of cortical cells and the epidermal



layer which had been occupied by the enlarged fruiting body which exploded to release ascospores (Plate 4.5.1f). Sections of roots harvested at 9 days after inoculation revealed the infection of both organisms (i.e an enlarging *B. theobromae* fruiting body and a developing second-stage juvenile (J<sub>2</sub>) of *H. sacchari*). The J<sub>2</sub> anterior portion was completely embedded in the feeding site (syncytium) induced by the nematode (Plate 4.5.1g). The cortical cells around the nematode and the fungus had turned dark-brown, compressed and disorganized (Plate 4.5.1g). There were two or six giant cells around the nematode and each giant cell contained dense cytoplasm and was multinucleate (Plate 4.5.1g). The third stage larvae were observed in the roots harvested 11 and 15 days after inoculation, longitudinal section of NERICA rice roots revealed infection of both fungus and the nematode. The fruiting body ruptured to release its spores while the nematode also established its feeding site; two syncytia were observed around the nematode head region. Large necrotic regions, damaged cortical cells, disorganized cells and considerable collapse of the epidermal cells and loss of cell structural integrity were also observed (Plates 4.5.1g and 4.5.1h). The same damage was observed at 21, 24 and 30 DAI although the extent of necrosis, cell disorganization and disintegration were more as the days progressed (Plates 4.5.2i, 4.5.2j, 4.5.2k 4.5.2l and 4.5.2m). At 30 DAI the nematode had completed its life cycle as eggs were seen (Plates 4.5.2l and 4.5.2m). Similarly, the fruiting bodies (cleistothecia) of the fungus had enlarged and also increased in number, the fruiting bodies (cleistothecia) were very close to the epidermal layer of the rice root in readiness to liberate its ascospores (Plate 4.5.2m)

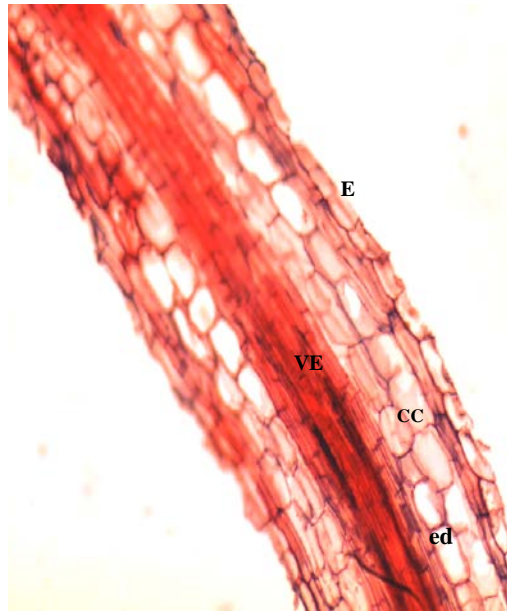

a Mag. X 100

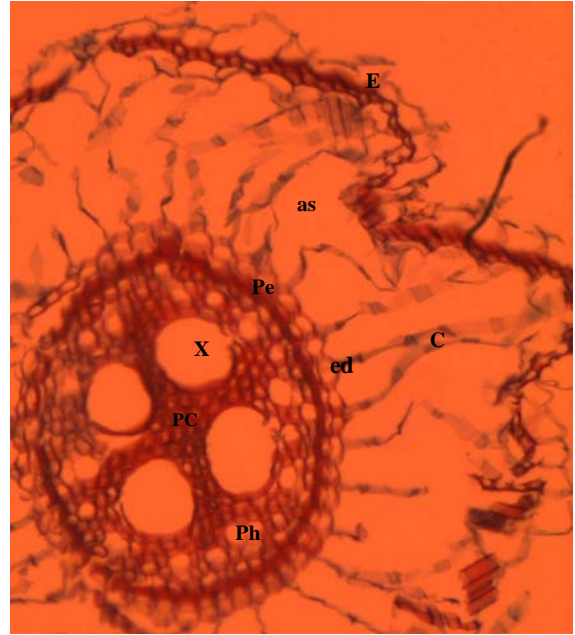

b Mag. X250

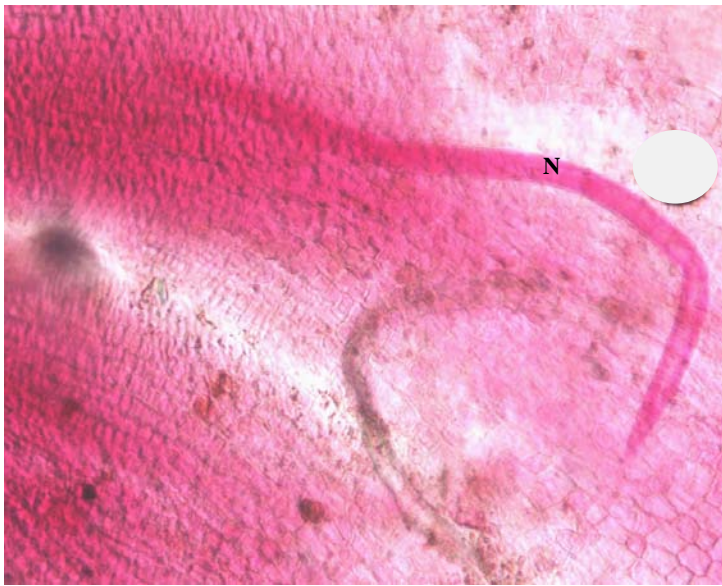

c Mag. X 100

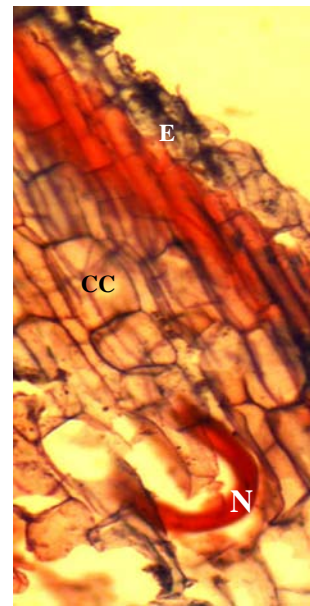

d Mag. X250

**Plate 4.4: Healthy and infected root sections of NERICA 1 rice.**

a = Longitudinal Section (LS) of healthy rice root, b = Transverse Section (TS) of healthy rice root, c = LS of rice root with second-stage juvenile ( $J_2$ ) of *Heterodera sacchari* (N) migrating within the root cells at 48hrs after inoculation, d = LS of second-stage juvenile of *H. sacchari* (N) at 4 days after inoculation. Epidermis (E), cortical cell (CC), endodermis (ed), vascular elements (VE), air space (as), phloem (ph), Xylem (x), pith (pc), cortex (C), pericycle (pe).

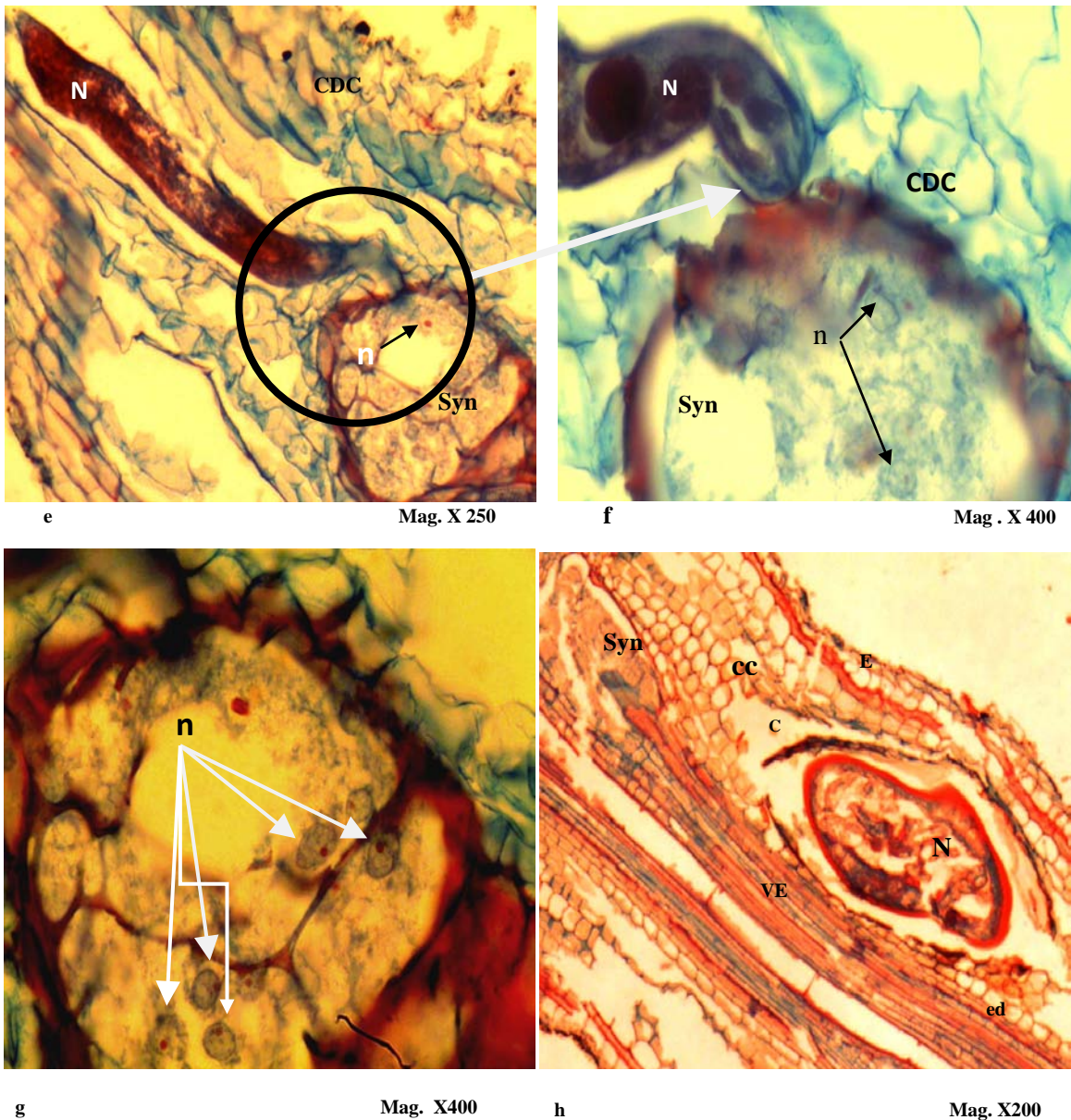

**Plate 4.4.1: Developing *Heterodera sacchari* and syncytium inside NERICA 1 rice root.**

e = Enlarged second-stage juvenile ( $J_2$ ) inside NERICA 1 rice root with syncytium at the nematode head seven days after inoculation (DAI), f = inset of anterior portion of nematode  $J_2$  and feeding site (syncytium), g = multinucleate cell at seven DAI, h = fourth-stage juvenile disrupting cellular integrity of NERICA 1 rice root and normal functions, and also large cavity around the nematode at 14 DAI. Epidermis (E), cortical cell (CC), endodermis (ed), vascular elements (VE), nematode cavity (C), compressed and disorganized cells (CDC), nematode (N), nucleus (n)



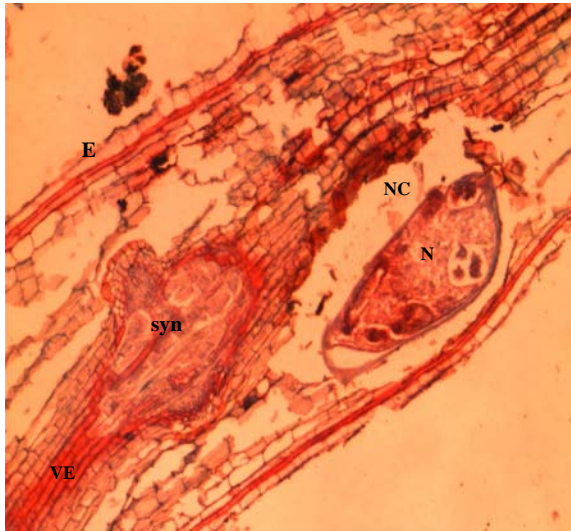

**i**

**Mag. X 100**

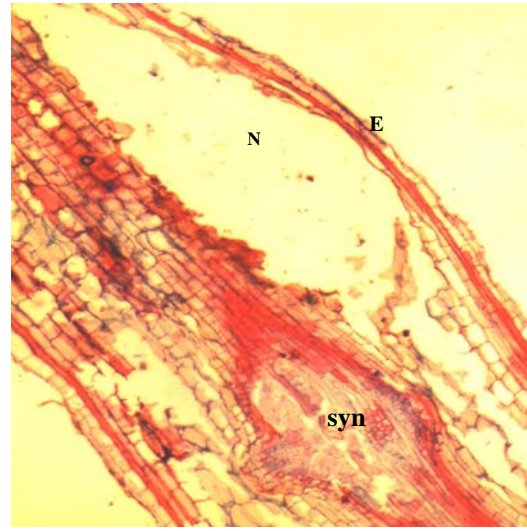

**j**

**Mag. X 100**

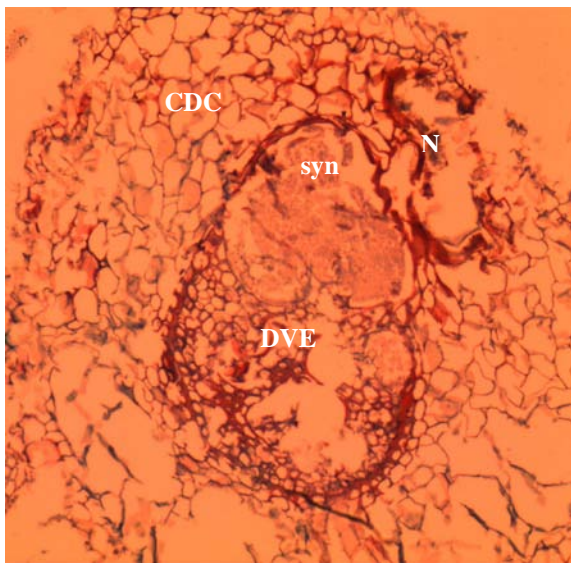

**k**

**Mag. X 200**

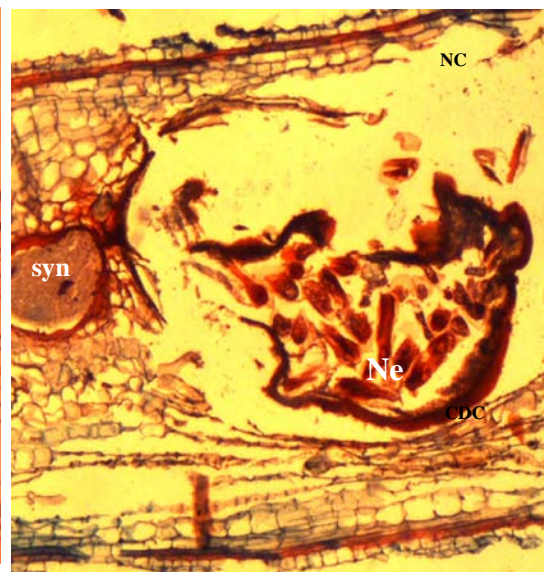

**l**

**Mag. X200**

**Plate 4.4.2: LS of NERICA 1 rice root with compressed, necrotic and disorganized cellular integrity.**

i = Pre-adult stage of *Heterodera sacchari* inside rice root and the syncytium (syn) disrupting the efficiency integrity of vascular element (VE) (19 DAI), j = Pre-adult stage of *H. sacchari* cavity within the cortical layer of infected rice root and the syncytium (syn) disrupting the efficiency integrity of vascular element (VE) (19 DAI), k = Transverse section (TS) of NERICA 1 rice root with nematode (N) cavity, syncytium (syn) and disorganized, compressed and degenerated vascular elements (DVE) and cortical cells (21 DAI), l = Longitudinal section (LS) of NERICA 1 rice root with a female nematode containing eggs (Ne), Epidermis (E), nematode cavity (NC), compressed and disorganized cells (CDC) (24 DAI).

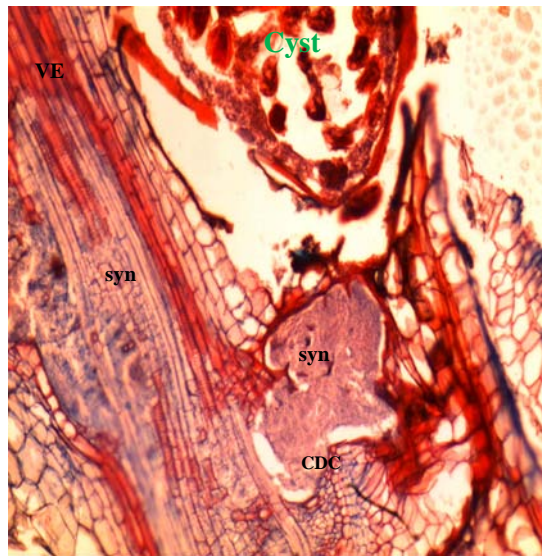

m

Mag. X250

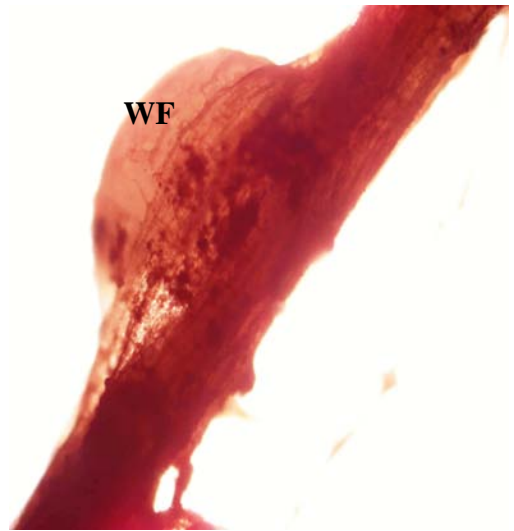

n

Mag. X250



o

Mag. X100

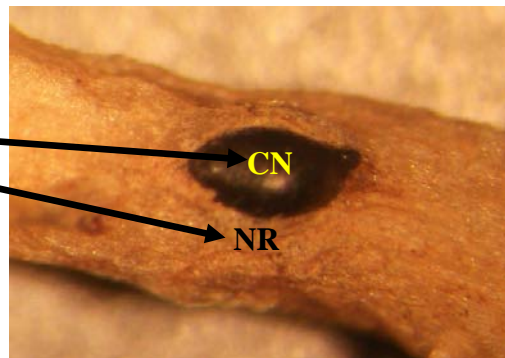

p

Mag. X250

**Plate 4.4.3: Infected NERICA 1 rice root with emerging adult white female nematode with eggs (24 DAI) and emerged cyst (29 DAI)**

m = LS with syncytium (syn) within the vascular elements (VE) and a matured female, n = matured white female (WF) emergence at 24 DAI, o and p = brown cyst nematode (CN) emergence on NERICA 1 root at 29 DAI; Epidermis (E) necrotic region (NR), compressed and disorganized cells (CDC).



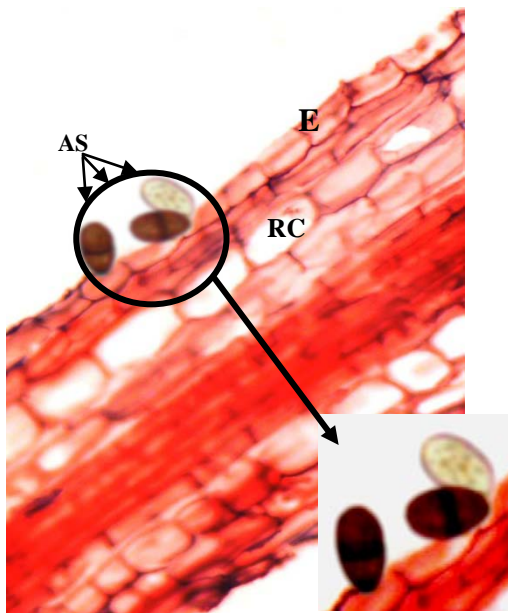

a

Mag. X 250

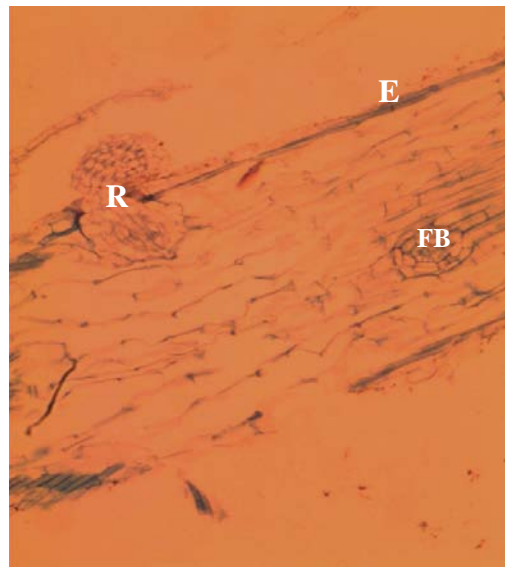

b

Mag. X 100

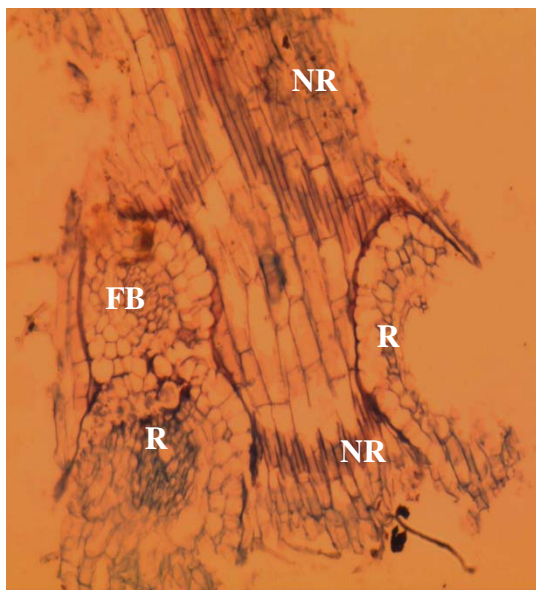

c

Mag. X 200

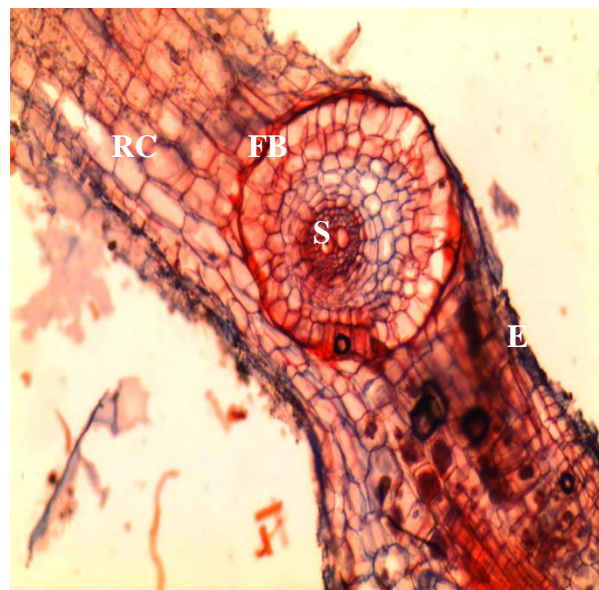

d

Mag. X 200

**Plate 4.5: Longitudinal Sections (LS) of NERICA 1 rice root infected with *Botryodiplodia theobromae*.**

a = Ascospores (AS) of *B. theobromae* on the epidermal layer of infected rice root 24 hours after inoculation, b = Ruptured (R) fruiting body (FB) of *B. theobromae* damaging and disrupting the efficiency of cortical cells (7 DAI), c = Ruptured (R) *B. theobromae* fruiting bodies (FB) and necrotic regions (NR) at eleventh day after inoculation (11 DAI), d = NERICA 1 rice root with enlarged fruiting body (FB) of *B. theobromae* within the root cells (RC) (17 DAI). Epidermis (E)

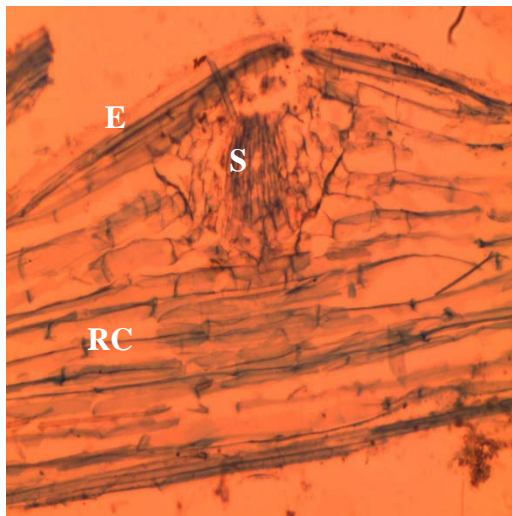

e

Mag. X 200

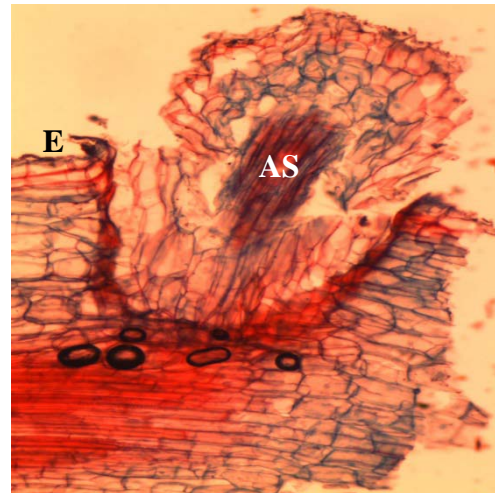

f

Mag. X 200

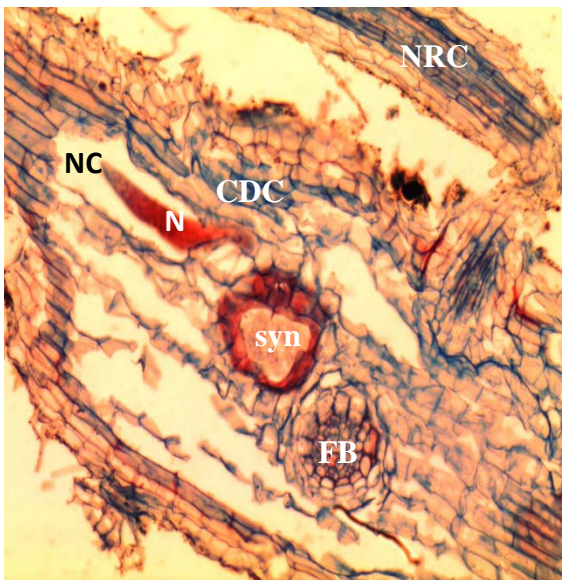

g

Mag. X 200

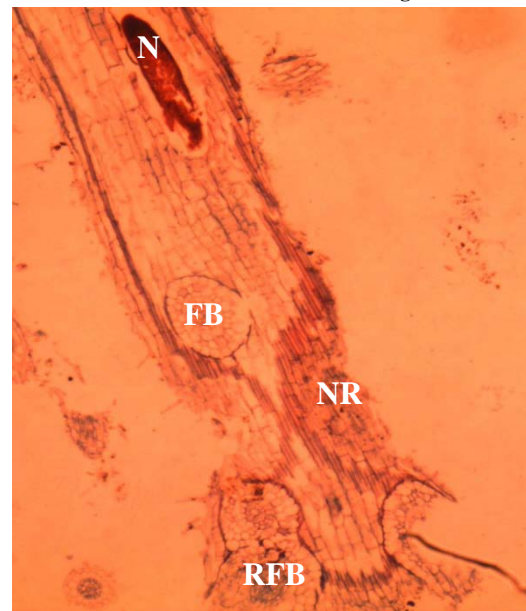

h

Mag. X 200

**Plate 4.5.1: Longitudinal Sections (LS) of NERICA 1 rice roots infected with *Botryodiplodia theobromae* and *Heterodera sacchari*.**

e = Rice root with *B. theobromae* within root cells (RC) ready to squirt out ascospores (S) at 18 DAI. Epidermis (E), f = Destruction of cortical cells and epidermal layer due to ascospores discharge (AS) by *B. theobromae* fruiting body (20 DAI), g = LS of NERICA 1 rice root showing a developing second-stage juvenile nematode (N) with a syncytium (syn) around the nematode head, and an enlarging *B. theobromae* fruiting body (FB). Compressed and disorganized cells (CDC), dead necrotic cells (NRC) at nine DAI, h = LS of rice root with fruiting bodies (FB) of *B. theobromae* and a developing third-stage juvenile ( $J_3$ ) of *H. sacchari* within the root cells, necrotic region (NR) and ruptured fruiting body (RFB) at 11DAI. Epidermis (E) and ruptured fruiting bodies (RFB).



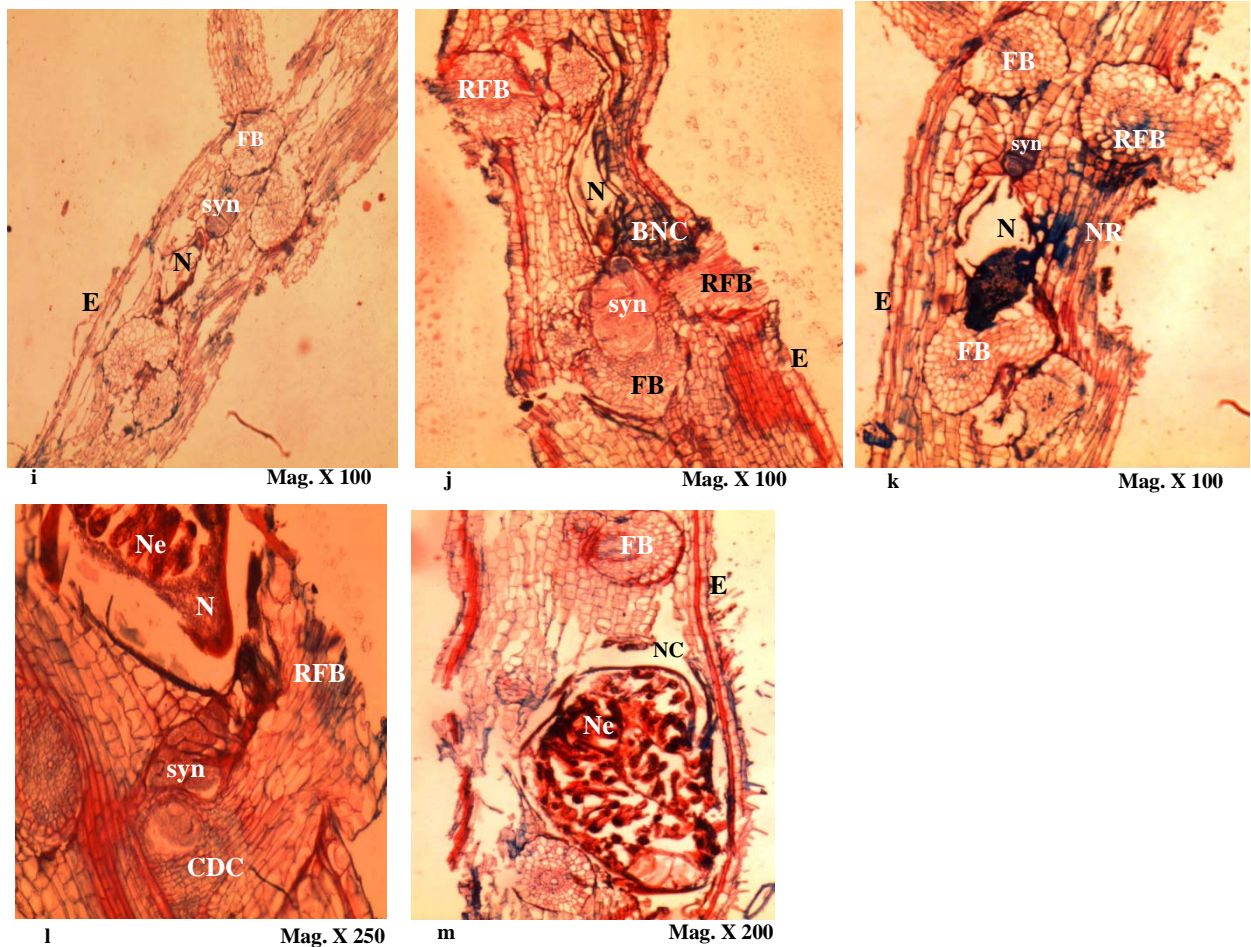

**Plate 4.5.2: Longitudinal Sections (LS) of NERICA 1 rice roots infected by *Heterodera sacchari* and *Botryodiplodia theobromae*.**

i = LS of rice root with J<sub>3</sub>, syncytium (syn) around the nematode (N) head and *B. theobromae* within cells disrupting the efficiency and cellular integrity of root tissue (15 DAI), j = Rice root with ruptured fruiting bodies (RFB) of *B. theobromae* during ascospore discharge, k = Rice root with ruptured fruiting bodies (RFB) of *B. theobromae* during ascospore discharge, nematode (N), blackened necrotic cells (BNC) and syncytium (syn) compressed disorganized and degenerated cells (15 DAI), l = LS of rice root showing ruptured fruiting body (RFB) of *B. theobromae*, nematode eggs (Ne) enclosed within cyst, syncytium (syn), compressed disorganized cells (CDC) at 21 DAI. m = LS of rice root showing nematode eggs (Ne) enclosed in a protective cyst and *B. theobromae* FB within root tissue disrupting the proper functions of the root at 30 DAI. Nematode cavity (NC), Epidermis (E) and ruptured fruiting bodies (RFB).



## CHAPTER FIVE

### 5.0 DISCUSSION AND CONCLUSION

The activities of plant-parasitic nematodes including *H. sacchari* are often influenced by environmental factors such as temperature, moisture content of the soil and host susceptibility which affect the survival, distribution, egg hatch, migration, penetration, development and symptom expression in plants. The rate of multiplication of *H. sacchari* varied considerably across rice cultivars used in this study. Based on cyst production rating, reproductive factor (RF), fresh root and shoot weight reduction, *Oryza sativa* and 14 out of the 16 upland NERICA rice cultivars were observed to be susceptible to *H. sacchari* infection while NERICA rice cultivars 6 and 8 were observed to be moderately resistant to *H. sacchari* infection, and CG 14 was rated as resistant, since it did not support the reproduction of *H. sacchari*. This corroborates the work of Babatola (1983a) who reported differences in the degrees of susceptibility among the 50 rice cultivars screened for resistance to *H. sacchari*.

Mature females of *H. sacchari* were also observed in large numbers along the root and root tips of susceptible rice cultivars. This was also observed by Babatola (1983a) who reported that the matured females of *H. sacchari* aggregated along the root systems of susceptible upland rice at 60 days after inoculating rice cultivars with 6 cysts of *H. sacchari* per litre of soil.

NERICA 6, 8 (rated moderately resistant) and CG14 identified to be resistant probably possess some resistant genes to *H. sacchari* which can be incorporated alongside with broad range of desirable agronomic characteristics in widely accepted and cultivated rice cultivars with a view to improving their yield. Reversat and Destombes (1998); Plowright *et al.* (1999) reported that *O. glaberrima* provides a high level of resistance to sedentary endoparasitic nematodes that can be transferred to improved hybrids. Plowright *et al.* (1999) also identified resistance to *H. sacchari* isolate from Côte d'Ivoire in rice hybrid WAB 450-I-B-160 (NERICA 6).

The moderately resistant cultivars identified in this study, may yield satisfactorily in *H. sacchari*-infested soils, they would however leave large population of cysts in the soil since they permit some level of nematode reproduction and suffer little or no damage. This could however be detrimental, if a susceptible NERICA rice cultivar that is generally acceptable is planted after the moderately resistant cultivar in a rotation schemes. They are therefore not suitable in crop rotation schemes with cyst nematode-susceptible crops. Planting of susceptible upland rice cultivars that support high reproduction of *H. sacchari* in infested soils, would however lead to a considerable yield loss in addition to leaving large population of cysts in the soil for subsequent cropping seasons. Resistant cultivars, because of their ability to suppress nematode multiplication, have been found to increase and stabilize yield of the crops. They are therefore useful in rotation scheme on *H. sacchari*-infested soils. If resistant cultivars are not acceptable to farmers and local markets, the resistance genes of these cultivars could be used in breeding program to improve the popular/acceptable susceptible cultivars. In order to avoid crop failure, the susceptible cultivars are not recommended for planting in soil infested with *H. sacchari*. However, where they are preferred for cultivation they could be planted in rotation with resistant cultivars, the use of resistant cultivar is compatible with the traditional cultural practices. It is simple, non-toxic, cheap and requires no specialized equipment or training to apply.

Finally, breeders should work in collaboration with phyto-nematologists during their breeding programmes so that cultivars/landraces with useful nematode resistant genes can be identified and incorporated with other desirable agronomic qualities that are generally acceptable to the end users. The development of NERICA rice genotypes with *H. sacchari*-resistance would be valuable in managing cyst nematode population in intensive cropping systems without the use of chemicals. Use of resistant crop cultivars would improve crop yield, reduce nematode reproduction and limit damage on the crops that follow. The use of resistant crop cultivars and integration of other compatible pest management options may be required for the control of cyst nematode due to their survival mechanism which enables them to protect eggs and juveniles within cysts. This survival mechanism enable *H. sacchari* to perpetuate itself and increase in population when conditions become

favourable in the next cropping season (Coyné and Plowright, 2000a) or even many years after fallow.

In the pathogenicity investigation, the results showed that the pathogenic effects of cyst nematode (*H. sacchari*) on upland NERICA rice cultivars increased with increase in the initial nematode population density. The reduction of mean plant height, number of leaves, leaf chlorophyll content, tillering, fresh shoot and root weight, grain yield, weight of 100 seeds of rice by *H. sacchari* observed in this work was similar to the findings of Salawu (1986). He reported a significant growth reduction of 5.8-7.7% in height, 3.7-20.0% fresh shoot and 2.7-37.8% fresh root weights in the local sugarcane variety (LS1-033). While in the exotic sugarcane (CO1001, CO957), variety CO957 had plant height reduced by 6.2% to 27.1%, fresh shoot weight reduced by 4.5% to 29.7%, fresh root weight reduced by 8% to 20.3% over the control as the population of *H. sacchari* increased from 2000 to 16000 nematodes per plant. *Heterodera sacchari* was also reported to cause significant decrease in dry panicle weight (44.9-54.4%) and grain yield (63.3-75.2 %) of rice ( cv Faro 11) at inoculum levels of 18, 36 and 72 cysts per litre of soil, respectively compared with control (Babatola, 1983b). Afolami and Orisajo (2003) also observed a significant reduction in plant height, number of tillers, number of panicles and grain yield in rice varieties IDSA 10, Moroberekan, WAB450-1-B-P-33-HB, WAB450-1-B-P-38-HB, FARO 43 and WAB340-b-b-1-HB, when rice cultivars were inoculated with 5000 eggs of *M. incognita* per plant in a pot trial. Coyné and Plowright (2000b) reported that height and grain yield of rice cultivar IDSA6 were severely reduced by 52.6% and 74.1 %, respectively at nematode inoculum density of 400 cysts of *H. sacchari* per plant.

The leaves of NERICA rice plants infected with *H. sacchari* in this investigation were chlorotic; leaf chlorophyll content was reduced significantly by 50.4% in the presence of 10,000 eggs and J<sub>2</sub> of *H. sacchari* at 11 weeks after inoculation in this study. This observation corroborated the work of Coyné and Plowright (2000b) who reported 54.8% reduction in leaf chlorophyll content of rice cultivar IDSA6 sown in sandy soil, inoculated with 400 cysts per plant. The root systems of *H. sacchari* infected plants became necrotic, dark brown, twiggy with severe root weight reduction, and root growth terminated at the point of nematode attack observed in this investigation corroborated the reports of earlier workers. Babatola (1983a) observed that the root systems of infected rice

plants were significantly reduced, necrotic and twiggy. Salawu (1986) also reported severely reduced and brown necrotic roots in sugarcane infected with 8,000 and 16,000 second stage juveniles per pot. Coyne and Plowright (2000b) also reported that *H. sacchari* is clearly pathogenic on susceptible upland rice in sandy soil and observed severe root damage compared with the uninfected plants.

Number of days to flower in NERICA rice cultivars grown in the pot experiment was delayed by *H. sacchari* at all inoculation densities by 7.3-11.5 days (this ranged from 77.7 days – 81.9 days) compared with the control which took 70.4 days to flower. This result is similar to that of Babatola (1983a) who observed delay in days to 50% flowering in upland rice, CV Faro 11, when plants were inoculated with 100 cysts per pot. He also observed a subsequent reduction in yield which ranged from 23.5% - 57.4% when Faro 11 was inoculated with 100 and 400 cysts, respectively. In the field, *H. sacchari* reduced the yield of NERICA rice by 50% (751.0 kg/ha) when compared with the control plants (1538.4 kg/ha) in the first trial and 84.7% in the second trial. This was due to the increase in the initial nematode population in the second season and continuous planting of rice on the nematode-infested field. The slow progressive hatch of *H. sacchari* would also continuously infect rice plants through the season in the infested field. This result is similar to the findings of Sharma *et al.* (2007) who reported yield reduction in the field which ranged from 15 - 20% on wheat due to *Heterodera avenae* in Pakistan, 40 - 92% in Saudi Arabia, and 23 -50% in Australia, as a result of continuous planting of wheat on *H. avenae* infested-field. This led to the increase in population of *H. avenae* in the field, and subsequent yield reduction. Similarly, in the Northern part of India, cereal cyst nematode (CCN) *H. avenae* can cause about 40-50% yield loss but can reach up to 60-65% in the wheat production area of Rajasthan, and yield loss was valued at US\$3.89 million (Sharma *et al.*, 2007). In Japan, yield loss due to *Heterodera glycines* in soybean-producing areas was estimated to be 10-75%. In the United States of America, yield loss due to *H. glycine* was valued at USD 1.5 billion in five states where soybeans is being produced (Chen *et al.*, 2001). *Globodera rostochiensis* and *Globodera pallida* (Potato cyst nematodes) have been reported to be major pests of the potato crop in cool-temperate areas where potatoes are grown. The amount of damage, with particular reference to weight of tubers, have been estimated to be approximately 2 t/ha of potatoes, for every 20 eggs/g soil. Up to 80% of

potato can be lost when populations of *G. rostochiensis* and *G. pallida* were raised to very high levels by repeated cultivation of potatoes on infested-field (Brown, 1969; EPPO/OEPP, 1991). Hajihassani *et al.* (2011) in a field survey reported up to 90% yield losses in wheat and barley crops grown in severely infested field by *H. avenae*, *H. filipjevi* and *H. latipons*. As a result of repeated cultivation of these crops on cyst nematode infested-field, there was uninterrupted build up of the nematodes in the field.

In addition, the penetration of *H. sacchari* second-stage juvenile (J<sub>2</sub>) into the root system, further explains the reduction in growth and yield of NERICA rice cultivar. The root tips of susceptible NERICA rice cultivars were pierced by the J<sub>2</sub> of *H. sacchari* with their stylets and subsequent movement of the second-stage juvenile to the vascular cylinder to establish a multinucleate feeding site called syncytium where *H. sacchari* diverts and consume cell contents for its development and reproduction. Melakeberhan and Ferris (1988); Melakeberhan (2004) reported that the amount of energy diverted and consumed by a nematode through a feeding site, during feeding, depends on nematode size, reproduction potential and host status. The cost to the host plant of supporting a single *M. incognita* from second-stage juvenile to the end of oviposition was 1.176 calories on a susceptible grape cultivar; however, one calorie is equivalent to approximately 0.213 mg plant dry weight or 0.4 mg CO<sub>2</sub>. If the nematode energy demand is proportional to its size (Atkinson, 1985; Melakeberhan and Ferris, 1988), then it is fair to assume that cyst nematodes (e.g *H. sacchari*, *H. glycines*) may consume more energy from their host than root-knot nematodes (RKN) because of the smaller size (Melakeberhan, 2004).

According to Melakeberhan (2004) reduction in top growth and subsequent yield reduction, could be due to the disruption of the root system by the destructive, adaptive and neoplastic feeding behaviour of *H. sacchari* which interferes with the physiological processes involved in water, nutrient utilization and phytohormones originating in the root (primary factors), thereby creating a cascade effect on chlorophyll synthesis, photosynthesis and respiration in the shoot (secondary factors). The combination of these primary and secondary effects subsequently lead to poor growth and productivity of infected rice compared with uninfected plants in both pot and field trials (Melakeberhan, 2004). The poor chlorophyll content of rice observed in this work was due to the damage done to the rice roots by *H. sacchari* infection and consequent inability of the roots to

transport mineral elements (such as magnesium, nitrogen) from the soil which are very essential in chlorophyll formation. This eventually led to reduction in the photosynthetic rates of plants due to nematode infection and this also contributed to reduction in the vigour of infected plants (Loveys and Birds, 1973; Wallace, 1974; Coyne and Plowright, 2000b). As for the reduction in root growth, high nematode density increases metabolic activities of the roots with increased mobilization and accumulation of photosynthates from the shoot to the syncytium but these do not add to the weight of the root because nematodes feed on them. Therefore, enough photosynthates would not be sent down for root growth (Melakeberhan, 2004).

Generally, it was also observed in this study that the number of white females and cyst recovered increased with increase in inoculum density. This result is consistent with the findings of Babatola (1983a); Reversat and Destombes (1998); Plowright *et al.* (1999); Audebert *et al.* (2000) reported that the number of nematodes increased exponentially with increase in initial population levels of *Heterodera* spp. on rice. Salawu (1986) also reported a steady increase of *H. sacchari* white females and cyst recovered from both soil and root as inoculum density increased on both local and exotic sugarcane varieties. NERICA 8 cultivar which was observed to be moderately resistant in the screening trial, had higher yield compared to other NERICA rice cultivars in this study at lower inoculation density (2,500 nematodes) but could not withstand nematode pressure when inoculum density was increased from 2,500-10,000 nematodes/plant. Number of nematodes at higher inoculation density at the completion of its first generation would have increased significantly hence increasing pressure of *H. sacchari* on rice root, thereby reducing the ability of NERICA 8 to withstand the nematode pressure. This may be due to the virulence that is common in cyst nematodes. Starr (pers. com) identified that virulence is very common in most cyst nematode species, therefore care will be needed to ensure durable resistance in order to reduce crop failure.

Mature females and cysts were observed emerging along the root axis and root tips of susceptible NERICA rice cultivars in this investigation, this was due to the cracking of the root epidermis as the females were increasing in size as a result of egg production required for reinfection when the conditions are favourable. This corroborated the findings of Salawu (1986) who reported that mature females of *H. sacchari* emerged and

aggregated along the root axis and root tips of both local and exotic infected sugarcane varieties. The cracking of the root epidermis appeared necessary for the mature females of the nematode to emerge. The initiation of the gelatinous matrix in which the eggs are deposited may not be formed without the mature females' emerging from the roots (Salawu, 1986). Also, the cracks on the roots are likely to facilitate the entry of the pathogens including fungi and bacteria.

The higher the initial nematode population, the higher the level of damage imposed on infected plants. Total cysts population recovered from soil and roots in the pot study increased with increasing inoculum level from 2,500 to 10,000 eggs and J<sub>2</sub> per plant. Similar results were reported by Babatola (1983a) and Salawu (1986) who observed maximum cysts as the initial inoculum density increased. The cysts recovered from *H. sacchari* at inoculation densities of 9, 18, 36 and 72 cysts per litre of soil in rice, CV Faro 11 were 636, 722, 992 and 1,818 cysts per 200 ml soil, respectively and in Sugarcane, CV LS1-033 inoculated with 2,000, 4,000, 8,000 and 16,000 second stage juvenile per 5 litre of soil, number of cysts recovered from 250ml soil were 192, 256, 245 and 407 cysts, respectively. In this study, the reproductive factor of nematode crashed at the inoculation level of 5,000 and 10,000 eggs and J<sub>2</sub> in pot experiment this is due to competition for available food resources and space required for nematode activities, survival and reproduction.

The findings in this study may prove useful in predicting the effect of minimum *H. sacchari* density that will have significant effects on the growth and yield of susceptible NERICA rice cultivars. At inoculum density of 2,500 eggs and J<sub>2</sub> per pot and above (ie >1 egg / 2 ml soil), NERICA rice growth and yield were reduced. This observation is in line with the findings of Coyne and Plowright (2000b) who reported that initial population of *H. sacchari* at 2 eggs per ml of soil was aggressive in the early stage of rice cultivar IDSA6. Hajihassani (2010) also reported that grain yield losses of 11, 31, 38 and 47% occurred at the initial population densities of 2.5, 5, 10 and 20 eggs and J<sub>2</sub> of *Heterodera filipjevi* per gram of soil in wheat, respectively. The degree of damage on growth and yield reduction exhibited by *H. sacchari* on NERICA rice cultivars indicates the suitability of NERICA rice as a host for this nematode and also emphasizes the importance of the nematode on the crop.

Furthermore, land tenure system and increased pressure on Agricultural lands for industrial, infrastructural and urban development (Nwauzor and Ihediwa, 1992), make farmers to plant same types of crops on the same nematode-infested piece of land year after year. This may result in the build up of nematode populations. This was evident in the field trials (2010 and 2011 cropping seasons) in this study where yield of NERICA rice was reduced by 50.1% in 2010 and 84.7% in 2011 cropping seasons with a corresponding increase in the population of cysts recovered from soil due to continuous cropping of rice on the same piece of land. Obviously, there may be total crop failure if a susceptible NERICA rice cultivar is grown on the same land in the subsequent seasons. Even if a moderately resistant rice cultivar is cultivated, there is high possibility of increased pressure of *H. sacchari* on the rice consequently leading to crop failure.

Therefore, a nematode management programme is essential to reduce pre-plant nematode population in an infested soil as its high potential fecundity will permit population density to reach an economic threshold which may lead to damage and yield loss. Also considering the difficulty in controlling this nematode, awareness should be created among rice farmers and other stakeholders about *H. sacchari* and its potential threats to the sustainability of intensive upland rice production particularly now that the Federal Government of Nigeria is interested in promoting the intensification of rice production for food security. Therefore, it is important to incorporate several control options available for a viable nematode management. An integrated management approach should be formulated which incorporates two or more compatible measures (such as solarization, use of resistant crop cultivars, cultural method, chemical method etc.), with a view to achieving effective, environmentally safe and economical management of *H. sacchari*.

The natural soil environment harbours a multitude of microorganisms. As many as  $10^6$ - $10^8$  bacterial cells,  $10^6$ - $10^7$  actinomycete cells,  $5.0 \times 10^4$ - $10^6$  fungal colony forming units (CFU),  $10^5$ - $10^6$  protozoa were estimated to be present in a gram of field soil taken from the surface (Gottlieb, 1976). Richards (1976) and Back *et al.* (2002) found  $1.0 \times 10^7$  nematodes in an area of  $1\text{m}^2$  of fertile soil. Plant-parasitic nematodes are primarily regarded solely as plant pathogens, capable of producing a single, recognizable disease (Powell, 1971; Prot, 1993 and Manzanilla-López *et al.*, 2004). All root-parasitic nematodes



cause mechanical injuries, either by simple micro-puncture or by rupturing or separating cells as they penetrate within or feed on root tissues. They may thereby either introduce a pathogen on or within their bodies or aid the entry of a pathogen already present on the plant cell surface (Corbett and Hide, 1971; Manzanilla-López *et al.*, 2004).

The results of the interaction between *H. sacchari* and *B. theobromae* on NERICA rice cultivars further explained the pathogenic effects of these two organisms on rice. The reduction of mean plant height, leaf number, leaf chlorophyll content and eventual death observed in NERICA rice cultivars was caused by nematode and fungus interactions four weeks after the inoculation of the two organisms either simultaneously or one after the other. This observation is similar to the findings of other workers (Jaritz, 1972; Sikora, 1977; Nordmeyer and Sikora, 1983) who reported abnormal alteration of the root as well as stunting and discoloration of subterranean clover (*Trifolium subterraneum* (L.)). Sikora (1977) isolated the cyst nematode, *Heterodera daverti* Wouts and Sturhan, and the fungi *Fusarium oxysporum* Schlecht *ex* Fr. and *F. avenaceum* (Corda *ex* Fr.) Sacc. from diseased plants. In this work, leaf chlorophyll content was reduced by 51.4% (*H. sacchari* alone), 56.1% (*B. theobromae* alone) and ranged from 51.2% to 60.3% in nematode-fungus infection. In this present study, the entire leaves of NERICA rice cultivars were chlorotic and dried up rapidly with eventual death of inoculated rice. This was observed when the two organisms were present together in NERICA rice, regardless of which organism was inoculated first. Nordmeyer and Sikora (1983) reported leaf chlorosis associated with simultaneous inoculations of *H. daverti* and *F. avenaceum* on '48G' appeared earlier than in single inoculation. Furthermore, leaf reddening as an additional symptom was produced by this interaction. Similarly, the presence of *Heterodera glycines* and fungus *Fusarium solani* cause sudden death syndrome (SDS) in soybean. In a microplot experiment conducted by McLean and Lawrence (1993); Rupe *et al.* (1993) and Back *et al.* (2002), they reported that the incidence of SDS symptoms in plots containing both *H. glycines* and *F. solani* were 35% and 18% higher than in plots where the fungus was inoculated alone. Rupe (1989) and Nakajima *et al.* (1996) observed root rot, crown necrosis, interveinal chlorosis, defoliation and abortion of pods in soybean plants. Xing and Westphal (2006) reported foliar symptoms (interveinal chlorosis and defoliation) of SDS-diseased soybean plants inoculated with both *F. solani* f.sp *glycines* and *H. glycines* at three or nine days

earlier than those caused by *F. solani* f.sp. *glycines* alone in a field microplot test. In the microplot trials, reduction in number of tillers, number of panicles, top and root weights, total seed and 100-seed weights were recorded at the inoculation of nematode and fungus alone, combination of either nematode and fungus a week before or after and simultaneous inoculation were not different from one another but were different over the control. Total number of panicle was reduced by 50%-64.9%, root weight by 62.1%-75.6%, total seed weight by 38.2%-65.1% and weight of 100-seeds by 12.5%-25% in all treatment combinations. *Heterodera schachtii* and *Fusarium oxysporum* on sugarbeet, were observed to cause significant decrease in fresh root weight by 71.1% (Jorgenson, 1970). Nordmeyer and Sikora (1983) reported that separate inoculations of *Fusarium* and *Heterodera daverti* caused yield reduction (dry weight) by 15% and 17% respectively in *Trifolium subterraneum*, similarly, 40% yield reduction was obtained when both organisms were inoculated simultaneously. Furthermore, inoculations of the nematode and the fungus resulted in 50% yield loss (Nordmeyer and Sikora, 1983). Back *et al.* (2002) in a review reported that *Globodera-Verticillium dahliae* and *Pratylenchus- Verticillium dahliae* disease complexes have become particularly notorious; early dying disease caused by *V. dahliae* and *albo-atrum* is accentuated by populations of *Pratylenchus* spp., *G. rostochienensis* (Evans, 1987) and *G. pallida* (Storey and Evans, 1987). Martin *et al.* (1982) reported that 15, 50 and 150 *P. penetrans* per 100cm<sup>3</sup> soil in combination with *V. dahliae* would result in 36, 60 and 75% reductions in potato tuber weight. Gao *et al.* (2006) reported that dual infestation with a high level of *Fusarium solani* f.sp *glycines* and 20,000 eggs of *H. glycines* caused severe root necrosis on soybean. Root and shoot dry weights were also reduced in high inoculation level of *F. solani* f.sp *glycines*. Similarly, soybean plant dry weight was reduced and root necrosis was increased by increasing the initial population density of *H. glycines* (Gao *et al.*, 2006). Brodie (1998) reported that *G. rostochiensis* together with *Rhizoctonia solani* resulted in much greater reduction in potato yield.

The results obtained from both greenhouse and field microplot trials showed that each parasite is capable of reducing the growth and yield of NERICA 1 and NERICA 2 rice cultivars used. *Heterodera sacchari* alone reduced fresh root weight and total grain yield by 69.6% and 57.7% respectively while *B. theobromae* alone reduced fresh root

weight and total grain yield by 62.1% and 38.2%, respectively. This is similar to the observation made by Jorgenson (1970) who reported that *H. schachtii* or *F. oxysporum* alone reduced the fresh root weight and yields of sugarbeets. Oyetunji (2009) also reported that *B. theobromae* alone reduced root of NERICA 1 rice by 65.2% and 28.6% in LAC23. The respective disease indices observed in simultaneous inoculations of the nematode and the fungus, nematode before or after the fungus and nematode alone was higher than the control and *B. theobromae* alone inoculation. The increase in disease index was due to the multiple disease pressure caused by the parasites on the root of inoculated NERICA rice cultivars. Nordmeyer and Sikora (1983) reported a significantly greater disease index in simultaneous inoculations, and when the nematode was inoculated one and two weeks after the fungus. Similarly, Manzanilla –Lopez and Starr (2009) reported that cotton cultivars that were highly resistant to wilt disease complex had greater incidence of vascular browning and plant mortality in the presence of *M. incognita* than when the nematodes were absent.

The reduction of top growth, root rot and subsequent yield reduction could be due to root destruction by *H. sacchari* and *B. theobromae* and utilization of nutrients and related resources by the feeding nematode and absorption of the root cell sap by fungus for its development. The enlargement of fungus fruiting bodies may exert pressure on the cortical cells and xylem vessels, which may be crushed and dislocated, thereby becoming less efficient in transporting water. The activity of the two organisms is to the detriment of the top growth which might have resulted from poor absorption of water and mineral salts leading to a decreased growth rate. Taylor and Sasser (1978) found infection with *Meloidogyne* to cause an increased protein synthesis in galls and the consequent disruption of growth regulators and other compounds between roots and stems and these resulted in profound disturbance of top growth. Root injury affects the amount of functioning roots directly and decreases proportionately the amount of water absorbed by the roots. Also there is a reduction in the photosynthetic rates of plants due poor chlorotic leaves as a result of nematode and fungus infection and thus contributed to reduction in growth rates (Melakeberhan, 2004). Melakeberhan (2004) reported that gibbrellins required for cell elongation and cytokinins required for cell division, translocation of photoassimilates and nutrients, and for chlorophyll synthesis are produced in the root tissues. Therefore, it is

likely that the injuries inflicted by *H. sacchari* and *B. theobromae* on the root system may decrease these root-originating phytohormones. This, in turn explains the common symptoms of stunting, chlorosis, leaf senescence and an uneven distribution and decrease of nutrient concentration in shoots of infected plants. It was also observed in this study that days to flowering was delayed by 14 days, and total seed weight and 100-seed weight were severely affected in the presence of the two parasites (i.e nematode inoculation first and followed by fungus one week later or vice versa) than when the nematode or the fungus was inoculated alone. *B. theobromae* alone reduced yield by 33.0% and 43.3% in both NERICA 1 and NERICA 2 respectively similarly, *H. sacchari* alone reduced total yield by 43.8% in NERICA 2 and 55.1% in NERICA 1. But in the combined inoculation of the two organisms, total yield losses ranged from 59.5%-70% and 60%-72.7% for NERICA 1 and NERICA 2, respectively. The reduction in weight of 100 seeds observed in infected NERICA rice plants revealed that there was poor grain fill of the rice panicles. Obviously, this result showed that there is a synergistic interaction between the organism and susceptible NERICA rice plants. This relationship can be summarized according to Back *et al.* (2002) as being positive when an association between two pathogens results in plant damage exceeding the sum of individual damage by pest and pathogen ( $1+1>2$ ). Furthermore, total number of second stage juveniles and total number of cyst in microplot were observed to be higher in the single inoculation of the nematode than when the nematode was inoculated with the fungus. This is probably because the nematode could multiply without any competition for food and other resources such as space within the roots of rice plants. *H. sacchari*, being an obligate parasite, was able to penetrate, establish feeding site, develop and cause further re-infection of healthy plant root. However, when both nematode and fungus are present, there is a competition for resources (such as water, nutrient and space) and *B. theobromae* being a rot fungus would have caused rot and subsequent reduction of plant root mass and this will limit the ability of the nematode to multiply and cause re-infection since the plant roots are dead. Also, rice plants were dead in the presence of both pathogens in some of the microplots. This is similar to the findings of Nordmeyer and Sikora (1983) who reported that interval between *Fusarium avenaceum* and *H. daverti* inoculations decreased the number of cysts produced, which might have been due to decreasing root mass, competition for nutrients and /or the release of fungal

metabolic by-products. They also observed dead plants of *T. subterranean* when nematode was inoculated one or two weeks after the fungus. The response (i.e reduced growth and yield) observed in NERICA 1 and NERICA 2 rice cultivars to single inoculation of *H. sacchari* or *B. theobromae*, and when the two pathogens were present together regardless of which one was inoculated first, could be due to the genetic similarities of the two NERICA rice cultivars. Semagn *et al.* (2007) reported that NERICA 1-7 belong to the same genetic group as revealed by cluster analysis using simple matching coefficients derived from SSR marker. In addition, these interspecific hybrids were specifically bred for resistance to leaf blast, lodging and insect attack but not to *H. sacchari* and *B. theobrome* infection.

The results of the anatomical changes or modifications induced by *H. sacchari* in the roots of rice (CV NERICA 1) revealed a typical susceptible reaction to infection by nematodes. These changes are similar to the findings of other researchers on different crops (Jatala and Jensen, 1976; Fawole, 1988; Salawu, 1986; Castillo *et al.*, 1999; Di vito *et al.*, 2000). The longitudinal and traverse sections of healthy and nematode-infected rice roots showed that the nematode second-stage larvae invaded rice roots using their protrusible stylet and releasing secretions containing cell-wall-degrading enzymes such as pectate lyase and  $\beta$ -1,4-endoglucanase (Williamson and Gleason, 2003; Abad *et al.*, 2009). They migrate intracellularly through the cortex until they settled and established a permanent relation with the host. The feeding activities of the cyst nematode, *H. sacchari* induced cellular alterations in the cortex, endodermis, pericycle and vascular parenchyma tissues of NERICA rice roots. Observations of cross-sections of *H. sacchari*-infected roots indicated that the nematode can induce the formation of both cortical and endodermal multinucleate giant cells and are known as syncytia. All the syncytia formed seem to be of xylem and phloem cell origin, since these syncytia have occupied the areas meant for the vascular elements. Cytological evidence suggests that syncytia are formed by the dissolution of the cell wall with enzymes produced by *H. sacchari*, breakdown of the vacuole, formation of granular cytoplasm and fusion of neighbouring protoplasts (Williamson and Gleason, 2003).

The destruction of the epidermal and cortical tissues of NERICA rice root by *H. sacchari* was similar to effects of *H. glycines* on soybeans (Endo, 1964; Jones and Perry,

2004), *Globodera rostochiensis* on tomato (Sembdner, 1963) and *H. mediterranea* on olive (Vovlas and Inserra, 1983; Castillo *et al.*, 1999). Salawu (1986) also reported the destruction of both epidermal and cortical tissues of sugarcane roots by *H. sacchari*. Complete penetration of the roots by the second-stage larvae occurred at the root-tip and later the nematode was found lying parallel to the root axis. This agrees with the findings of Endo (1975) and Salawu (1986) who reported that the entry of *Heterodera* larvae was by direct penetration of root-tip cells. Scanty cytoplasmic contents of cortical and phloem cells observed in this investigation suggests that during the development from one larval stage to another, the nematode fed on the cells for its growth. In this investigation, formation of well established syncytium was observed in rice roots infected by *H. sacchari* seven days after inoculation. In this root, the nematode established a permanent feeding site in a cortical cell that was fused with adjacent cells forming the syncytium. A syncytium expanded into the cortex by fusion of cortical cells. In other cases, the nematode penetrated into the cortex and established a permanent feeding site in the endodermal tissues. These cells fused with adjacent pericycle cells forming a large syncytium into the vascular element. Similarly, it was also observed that there was increase in cytoplasmic contents in some cortical cells, each with large nuclei. These observations are similar to those of effects of *G. rostochiensis* on potato, *H. avena* on wheat, *H. schachtii* on sugarbeet, *H. trifolii* on red clover, *H. geottingiana* on peas, beans and soybean, *H. cruciferae* on Brussels, *H. carotae* on carrot and *H. oryzae* on rice, as reviewed by Stone (1973). William and Siddiqi (1972), Stone and Course (1974), Luc and Taylor (1977), Vovlas and Inserra (1983) and Castillo *et al.* (1999) respectively, showed that the nematodes stimulated syncytium in their hosts. Vovlas and Inserra (1983) observed enlarged syncytium between 3-5 days after inoculation, they also reported that the cytoplasm of active syncytia was dense and contained small globules and numerous hypertrophied nuclei and nucleoli on sectioned olive roots. The syncytium induced by *H. sacchari* function as a specialized sinks supplying nutrients to the nematode until reproduction. Jones and Perry (2004) reported that potato cyst nematode (PCN) maintain the syncytium drawing all the nutrients required for development through a series of moults to the adult male or female. According to Endo (1971), certain unidentified stimulants produced during the feeding activities by these nematodes, have been indicated

to be responsible for the development of syncytium. In recent times, research has shown that cyst nematode infection upregulates genes that encode host cell-wall-degrading enzymes, host plant endoglucanase and polygalacturonase (cell-wall-degrading enzymes) genes are upregulated after infection by cyst nematode (Williamson and Gleason, 2003). Increase in size of nuclei will facilitate increase in metabolic activities of the cells. Endo (1970) reported nucleic acids at the infection sites penetrated by larvae of *H. glycines* on susceptible 'Lee soybean'. He also noted an increase in nuclear size and deoxyribonucleic acid (DNA) synthesis. Endo and Veech (1971) similarly showed an increase in enzyme levels as syncytia developed in susceptible 'Lee' variety of soybeans infected by *H. glycines*. Similarly, Castillo (1999); Jones and Perry (2004) reported nucleic acids at the infection sites penetrated by larvae of PCN on susceptible potato and *H. mediterranea* on olive. Jones and Perry (2004) also noted an increase in nuclear size and deoxyribonucleic acid (DNA) synthesis was stimulated. The xylem tissues, phloem tissues and pith cells were invaded by *H. sacchari*. These tissues were extensively damaged by the nematode. Since the nematode traverse the endodermis, it then feeds on parenchymatous phloem and xylem tissues and this will adversely affect supply of food and water to other parts of the plant, consequently, wilting, stuntedness, poor chlorophyll content and other above ground symptoms will be observed due to *H. sacchari* infection on rice.

Although there is little or no information on the host parasite relation of *B. theobromae* and *H. sacchari* infection on susceptible NERICA rice. The results of this investigation showed the anatomical changes or modifications induced by *B.theobromae* in the roots of NERICA 1 rice revealing a typical susceptible reaction to infection by the fungus (*B. theobromae*). These changes are consistent with the findings of Agrios (2005). In response to the development of fruiting body, some cortical cells were compressed, disorganized and ruptured epidermal and cortical cells with dark brown color were seen. The cell sap of the adjacent cells around the fruiting body was used up by the fungus and the cells were plasmolysed and necrotic regions were observed wherever there is ascospore discharge at 7 and 11 DAI respectively. At 17 DAI, the fruiting body became enlarged due to turgor pressure caused by uptake of fluid from the adjacent plant cells surrounding the fungus. At 17 DAI, the fruiting body (ascocarp) became enlarged due to turgor pressure caused by uptake of cell sap from the plant cells. Between 18 and 20 DAI, fruiting body

(ascocarp) had stretched, compressing surrounding root cells, eventually burst open and squirting out the ascospores. Furthermore, by 17 DAI, some of the cortical cells seemed to have been colonized by the fungus spreading its hyphae around the intracellular spaces. The pathogen spread to various tissues in the cortex causing breakdown. The destruction of the epidermal and cortical tissues of susceptible NERICA rice by *B. theobromae* was similar to that of *B. theobromae* on grapevine (Atia *et al.*, 2002). The phloem and the xylem tissues which are responsible for food and water transportation were not invaded by *B. theobromae*. This suggests why the plant could still transport food and water to other parts of the plant. Probably, the thick and highly lignified cell walls of metaxylem which contained little or no food might have formed a strong barrier against the fungus. This explains why plants treated with *B. theobromae* alone in the interaction trial were better than those treated with nematode alone or in various nematode-fungus combinations (ie nematode a week before the fungus or vice versa and nematode-fungus inoculated simultaneously).

At nine DAI the second-stage larve and the fungus ascocarp were in the cortical region of the root of suceptible NERICA rice. The nematode established a permanent relation with the host by inducing a syncytium where the nematode derived nourishment. The nematode developed into mature females and reproduced in the presence of the *B.theobromae*. Similarly, the fungus also established permanent relation with the plant cells and began to develop and enlarge in size. The cells around the fungus were compressed, disorganised with dark necrotic regions. Cavity created by the third stage juvenile of the nematode and an enlarged fruiting body of the fungus where also present in the cortex of infected rice root, necrosis was observed and cortical cells and epidermal cells were extensively damaged. At 15 DAI fourth stage juvenile of the nematode was observed in the presence of four enlarged fruiting bodies. The cells were completely destroyed and the structural integrity of the roots had collapsed.

At 21 DAI cells in the cortex were disorganised and intracellular spaces were filled with fungal hyphae, nematode multinucleate syncytium essential for *H. sacchari* growth, development and reproduction because they are essentially transfer cells passing nutrients to the nematodes was also present. Since nematodes depend on syncytium for feeding, adult nematodes are usually found concentrated in the vascular tissue of the roots where



syncytium had established. In this investigation, whether the fungus was introduced before the nematode or vice versa, both organisms still developed, reproduced and caused multiple and extensive damage of susceptible NERICA rice root. It is worthy of note, that when nematode was inoculated seven days after the fungus, the nematode still developed into a matured female and reproduced for reinfection of healthy roots in 30 days. However, when the nematode was introduced before the fungus, the nematode completed its development in 24 DAI. The sudden death observed in some of the rice plants in both greenhouse and microplot trials suggests that when the plants were inoculated simultaneously with nematode and fungus, there is multiple infection pressure of both pathogens on the plant subsequently leading to the death of the plants. Such that the nematode will extensively destroys the cortex and vascular system. Also, *B. theobromae* resides and destroys root cortex and the epidermal layer of the plant root. Furthermore, the cracks made on root by the enlarged adult females which usually ruptures the root cortex and thereby providing easy and more entry sites for the fungus. When the two pathogens were present, infected plant cells were dark brown and necrotic. This explains why the yield of inoculated plants was synergistically affected by the presence of the two pathogens. It is important to note that planting of cassava or yam in rotation in order to control *H. sacchari* may not be appropriate as it could lead to the build up of other important rice pathogens like *B. theobromae*, *Aspergillus niger*, *Penicillium oxalicum*, *Trichoderma longibrachyatum*, *Sclerotium rolfsii*, *Meloidogyne incognita* and *Pratylenchus* spp. Therefore, infested field may serve as a source of primary inoculum in subsequent cropping seasons. It is therefore, very imperative to formulate a compatible holistic management option (i.e integrated pest management) such as the use of resistant crop cultivars, soil solarisation, cultural method e.t.c in managing *H. sacchari* and *B. theobromae* on infested fields.

### **5.1 Summary and Recommendations**

The results of the investigation on the resistance of the interspecific progenies of *O. sativa* and *O. glabberima* (i.e NERICA rice cultivars) to *Heterodera sacchari* showed that the tested upland NERICA rice cultivars were moderately resistant to and highly susceptible to the nematode. Two of the NERICA rice cultivars, NERICA 6 and NERICA 8, were moderately resistant to *H. sacchari* infection. In order to get good yield, NERICA

rice cultivars should be planted on *H. sacchari* free soil in order to attain its full genetic potential. In addition, breeding for nematode resistance should be incorporated into future breeding programmes in order to improve on the resistance of NERICA rice cultivars to *H. sacchari* probably by backcrossing the NERICA rice cultivars with CG14 which is resistant to *H. sacchari*. This study further demonstrated the pathogenic effects of *H. sacchari* on upland NERICA rice cultivars. *H. sacchari* inhibited shoot and root growth while the yield and grain fill were also reduced. Root damage increased with increase in nematode inoculum density. NERICA 8 rice cultivar that exhibited some level of resistance at lower *H. sacchari* population could not withstand the pressure of increasing *H. sacchari* population. This was confirmed in the plant vigour and yield quantity as the nematode population was increased from 2,500 eggs and juveniles (J<sub>2</sub>) to 10,000 eggs and J<sub>2</sub> of *H. sacchari*. Therefore, NERICA 8 could be improved upon through breeding programme in order to stabilize the durability of its resistance to *H. sacchari*. Furthermore, in the investigation of the interaction between *H. sacchari* and *B. theobromae* on upland NERICA rice cultivars, it was observed that the various combinations of the two pathogens synergistically inhibited the shoot and root growth, increased root damage, delayed flowering, poor grain fill and total yield loss and in some cases eventual death of plant.

The histopathological study revealed that upland NERICA rice cultivars exhibited a typical *Heterodera* spp susceptible reaction. Nematodes were observed in the root cells compressing the adjacent cells thereby causing cell disruption and disorganization in the cortex, endodermis and vascular cells. This is accompanied by the formation of syncytium which is necessary for a successful host/nematode relationship. These are nurse cells on which the cyst nematode feeds. Eggs were similarly observed within the cyst inside the cortical cells.

The histopathological study of the interaction between *H. sacchari* and *B. theobromae* revealed that upland NERICA rice cultivar exhibited a typical *Heterodera* spp/ susceptible reaction. The fruiting body of the rot fungus was observed to increase in size, compressing and disorganizing cortical cells and necrotic regions were observed where the fungus had released its ascospores. Similarly, nematodes were observed in the root cells compressing the adjacent cells thereby causing cell disruption and disorganization in the cortex, endodermis and vascular cells. This is accompanied by the formation of syncytia which are necessary for

a successful host/nematode relationship. These are nurse cells on which the cyst nematode feeds. Eggs were similarly observed within the cyst emerging from the cortical cells onto the root surface. The fungus and the nematode were able to develop, reproduce, multiply and cause reinfection of healthy plant roots leading to multiple disease pressure on upland NERICA rice cultivars.

From the foregoing, it is abundantly clear that *H. sacchari*, *B. theobromae* and their various interactions are major constraints to upland NERICA rice cultivars production. It has equally been demonstrated that *H. sacchari* is pathogenic to upland NERICA rice both in screenhouse and field studies causing stunting, delayed flowering, poor grain fill and subsequently yield reduction. This is as a result of root damage, cell disruption and disintegration and formation of large cells (syncytium) which transfer nutrients meant for plant growth to nematodes as revealed in histopathology studies. The fact that the nematode completed its life cycle within 24 days suggests that three or more generations of *H. sacchari* are possible in upland NERICA rice farms in a growing season thereby leaving behind a large nematode population. And similarly, *B. theobromae* also can enlarge and release its ascospores at seven days interval suggest that large ascospore deposits will be left behind at the end of the growing season. It is also possible that the nematode may be modifying the host substrates and also increasing the number of infection sites which enhances host susceptibility to fungus and subsequent multiplication within the root system.

Therefore, there is the need to work out effective nematode control strategy in order to improve growth and yield of upland NERICA rice. Employment of integrated nematode management strategy is the way out of this problem which involves the use of two or more compatible nematode control methods which is cost effective and ecologically safe. Towards this end, the development of *H. sacchari* resistant NERICA rice cultivars and soil solarisation are recommended for the management of *H. sacchari* and *B. theobromae*. This is because resistant cultivars are cheap and give a long term solution to nematode damage. They do not require special equipment, expertise or extra capital investment like chemicals and more over, yield from resistant cultivars outyields susceptible cultivars grown in nematode-infested soils. Furthermore, since resistant cultivars inhibit nematode reproduction they could permit the cultivation of susceptible cultivars in rotation schemes. In addition, their genes can be used to improve the nematode-susceptible ones. Similarly, cassava or yam should not be used in

rotation schemes in order to reduce *H. sacchari* population because this may probably lead to the build up of *B. theobromae* on the farm since the two crops are very good hosts to *B. theobromae* and other rot fungi. The interaction of the two organisms will lead to further damage on the crop. Above all, farmers need to be enlightened about nematodes and fungus interaction and their negative impacts on crops.

## REFERENCES

- Abad, P., Castagnone-Sereno, P. Rosso, M., Engler, J.A. and Favery, B. (2009). Invasion, Feeding and Development. In: Root-Knot Nematodes, Ed; Perry, R.N, Moens, M. and Starr, J. L. CAB International, 163-181pp
- Adesiyan S.O. R.A. Odihirin and M.O. Adeniji (1975). Histopathology studies of the yam tuber (*Dioscorea rotundata*) Poir infected with *Scutellonema bradys* (Steiner and LeHew). *International Biodentn. Bull.* **11**(2):48-55
- Adesiyan, S.O., Caveness, F.E Adeniji, M.O. and Fawole, B. (1990). *Nematode pests of tropical crops*. Heinemann Education Book (Nigeria) Limited. 114pp
- Afolami, S.O. and Orisajo, S.B. (2003). Searching for resistance to root-knot nematodes: the case of NERICA upland rice compared with some elite Asian varieties in Nigeria. *Nigerian Journal of Plant Protection.* **20**: 25-40
- Agrios, G.N. (2005). Parasitism and Disease Development. In: Plant Pathology, Fifth edition Elsevier academic press. UK 901.pp
- Akinyele, B. and Ikotun, T. (1989). Micro-organisms associated with cassava tuber rot. IITA Root, tuber and plantain improvement programme Annual Report IITA Ibadan, Nigeria. Pp16-18
- Alam, M.M., Saxena, S.K. and Khan, A.M. (1978) Suitability of crops to certain ectoparasitic nematodes. *Acta Botanica Indica* **6** (Supplement), 205-208.
- Alam, S.M., Begum, F., Sarkar, M., Rafiqul-Islam, M. and Alam. S.( 2001). Effect of Temperature, Light and Media on growth, sporulation, formation of pigment and pycnidia of *Botryodiplodia theobromae* Pat. *Pakistan Journal of Biological Sciences* **4** (10): 1224-1227
- Atia, M.M.M., Aly, A.Z., Tohamy, M.R.A., El-Shimy, H. and Kamhawy, M.A (2002) Histopathological Studies on Grapevine Die-back. *Journal of Plant Diseases and Protection* **110**(2), 131-142.
- Atkinson, H.J. (1985) The energetic of Plant-parasitic nematodes- a review. *Nematologica* **31**: 62-71
- Audebert, A., Coyne, D.L., Dingkuhn, M. and Plowright, R.A. (2000). The Influence of Cyst Nematodes (*Heterodera sacchari*) and Drought on Water Relations and Growth of Upland Rice in Côte d' Ivoire. *Plant and Soil* **220**: 235-242

- Babatola, J.O. (1983a) Rice Cultivars and *Heterodera sacchari*. *Nematologia Mediterranea* **11**, 103-105.
- Babatola, J.O. (1983b) Pathogenicity of *Heterodera sacchari* on rice. *Nematologia Mediterranea* **11**, 21-25.
- Babatola, J.O. (1984) Rice Nematode Problems in Nigeria; their occurrence, distribution and pathogenesis. *Tropical Pest Management* **30**, 256-265.
- Babatola, J.O. and Bridge, J. (1980) Feeding behavior and histopathology of *Hirschmanniella oryzae*, *H. imamuri* and *H. spinicaudata* on rice. *Journal of Nematology* **12**, 48-53.
- Back, M.A., Haydock, P.P.J. and Jenkinson, P. (2002). Disease Complexes Involving Plant parasitic Nematodes and Soilborne Pathogens, Plant pathology. *Plant Pathology* **51**: 683-697
- Baqri, Q.H. and Ahmad, N. (2000) Qualitative and quantitative studies of plant and soil inhabiting nematodes associated with rice crop in Sikkim, India. *Records of Zoological survey of India* **98**, 137-148.
- Bidaux, J.M. (1978). Screening for Horizontal Resistance to Rice Blast (*Pyricularia oryzae*) in Africa; In Rice in Africa, Buddenhagen, I.W. and G.J. Persley (Eds) pp 159-174
- Bird, A.F (1962). The inducement of giant cells by *Meloidogyne javanica*. *Nematropica* **8**:1-10.
- Boher, B., Ptcholo, A. and Tchabama, B. (1997). Identification of the factors enhancing the occurrence of an unusual stem and root rot in cassava in Togo. Cultural practices are accused. *Cashiers- de-la- Recherche- Development*, **43**: 52-58.
- Brar, P.S. and G.S. Khush. (1986). Wide Hybridization and Chromosome Manipulation in Cereals. In Evans, D.A, Sharp, W.R. and Ammirato, P.C (Eds); *Hand book of Plant Cell Culture*. **4**: 221-256.
- Bridge, J. and Page, S.L.J. (1982) The rice root-knot nematode, *Meloidogyne graminicola*, on deep water rice (*Oryza sativa* subsp. Indica). *Revue de Nematologie* **5**, 225-232.
- Bridge, J., Plowright, R.A. and Peng, D. (2005). Nematode Parasite of Rice: In Plant Parasitic Nematodes in Subtropical and Tropical Agriculture. (Eds) Luc, M., Sikora, R.A. and Bridge, J. Wallingford, U.K., CAB International, pp 87-130.
- Brodie, B.B. (1998). Potato. In: Plant and Nematode Interactions. Bartels, J.M., Barker, K.R., Pederson, G.A. and Windham, G.L. (Eds). Agronomy series No. 36.

American Society of Agronomy, Inc., 677 South Segoe Road, Madison, WI 53711 USA, 567-594pp.

- Brown, E.B. (1969) Assessment of the damage caused to potatoes by potato cyst eelworm *Heterodera rostochiensis* Woll. *Annals of Applied Biology* **63**, 493-502.
- Cartwright, R. and Lee, F. (2003). Management of rice diseases: In Rice production handbook. (Ed) Slaton, N.A. Cooperative Extension Service, University of Arkansas Print Media Center, Little Rock, pp 87-100
- Castillo, P., Mora-Rodriguez, M.P., Nava-Cortes, J.A. and Jimenez-Diaz, R.M. (1998). Interactions of *Pratylenchus thornei* and *Fusarium oxysporum* f.sp *ciceri* on Chickpea. *Phytopathology* **88**: 828-36.
- Castillo, P., Vovlas, N., Nico, A.I and Jiménez-Díaz, R.M. (1999). Infection of Olive trees by *Heterodera mediterranea* in Orchards in Southern Spain. *Plant Dis.* **83**:710-713.
- Castillo, P., Navas-Cortes, J.A., Gomar-Tinco, D., Di-vito, M. and Jiménez-Díaz, R.M. (2003) Interactions between *Meloidogyne artiellia*, the cereal and legume root-knot nematode, and *Fusarium oxysporum* f. sp. *Ciceris* race 5 in chickpea. *Phytopathology* **93**, 1513-1523.
- Caveness, F.E. (1967) Shade-house host ranges of some Nigerian nematodes. *Plant Dis. Rept.* 51 (1): 33-37.
- Chen, S., MacDonald, D.H., Kurle, J. E. and Reynolds, D. A. (2001). The soybean cyst nematode. University of Minnesota Extension Service. Web/URL: <http://www.soybean>
- Cook, R and Noel, G.R. (2002) Cyst Nematodes: *Globodera* and *Heterodera* Species; In Plant Resistance to Parasitic Nematodes. (Eds) Starr, J.L., R. Cook, and Bridge, J. Wallingford, U.K., CAB International, pp 71-101.
- Corbett, D.C. and Hide, G.A. (1971). Interaction between *Heterodera rostochiensis* Woll and *Verticillium dahliae* Kleb. on potatoes and the effect of CCC on both. *Ann. Appl. Biol.*, **68**: 70-80
- Coyne, D.L. (1999) Epidemiology and crop loss assessment of rice nematodes in West Africa. Ph.D Thesis, dept. of Crop of Agriculture, University of Readings, United Kingdom.212 pp
- Coyne, D.L. and Plowright, R.A (2000a) *Heterodera sacchari*: field population dynamics and damage to upland rice in Côte d' Ivoire. *Nematology* **2**, 541-550.

- Coyne, D.L. and Plowright, R.A. (2000b). Pathogenicity of Cyst Nematode, *Heterodera sacchari*, on Rice in sand and clay soil. *International Rice Research Notes (IRRN)*. **25**: 1
- Coyne, D.L., Hunt, D.J., Plowright, R.A. and Darboe, M.L.K. (2000). Further observations on nematodes associated with rice in Côte d' Ivoire, The Gambia, Guinea and Togo. *International Journal of Nematology*: **2** (10): 123-130
- Coyne, D.L., Nicol, J.M. and Claudius-Cole, B. (2007) *Practical plant nematology: A field and laboratory guide*. SP-IPM Secretariat, International Institute of Tropical Agriculture (IITA), Cotonou, Benin. Pp 42-47
- Coyne, D.L., Plowright, R.A. and Fofana, I. (1996) Preliminary investigations of nematodes associated with rice in Guinea, Benin and Togo. *Afro-Asian Journal of Nematology* **6**, 70-73.
- Coyne, D.L., Plowright, R.A., Twumasi, J. and Hunt, D.J.H. (1999) Prevalence of plant parasitic nematodes associated with rice in Ghana with a discussion of their importance. *Nematology* **1**, 399-405.
- Coyne, D.L., Smith, M. and Plowright, R.A. (2001) Plant parasitic nematode populations on upland and hydromorphic rice in Côte d' Ivoire: relationship with moisture availability and crop development on a valley slope. *Agriculture, Ecosystem and Environment* **84**, 31-43.
- Das, P.K. and Rao, Y.S. (1970) Life history and pathogenesis of *Hoplolaimus indicus* in rice. *Indian Phytopathology* **23**, 459-464.
- Daykin, M.E. and Hussey, R.S. (1985) Staining and Histopathological Techniques in Nematology: In *Advanced Treatise on Meloidogyne Volume II: Methodology* (Eds) Barker, K.R., Carter, C.C. and Sasser, J.N. North Carolina State University Graphics, Raleigh, USA. Pp 39- 48.
- Di-Vito, M., Vovlas, N. and Castillo, P (2004). Host-parasite relationships of *Meloidogyne incognita* on Spinach; *Plant Pathology* **53**: 508-514.
- Endo, B.Y. (1964). Penetration and Development of *Heterodera glycines* in Soybean roots and related anatomical changes. *Phytopathology* **54**: 79-88
- Endo, B.Y. (1970) Nucleic acid synthesis at soybean infection sites invaded by soybean cyst nematode. *Phytopathology* **60** (6): 1014 (Abstr.)
- Endo, B.Y. (1971) Synthesis of nucleic acid at infection sites of soybean roots parasitised by *Heterodera glycines*. *Phytopathology* **61** (4): 395-399.



- Endo, B.Y. (1975). Pathogenesis of Nematode- Infected plants. *Ann. Rev. Phytopathol.* **13**: 213-237.
- Endo, B.Y. and Veech, J.A. (1970) Morphology and histochemistry of soybean roots infected with *Heterodera glycines*. *Phytopathology* **60** (10): 1493-1498
- EPPO /OEPP (1991). European and Mediterranean Plant Protection Organisation. Quarantine procedure No. 30, *Globodera pallida* & *G. rostochiensis*, soil sampling methods. *Bulletin OEPP/EPPO Bulletin* **21**, 233-240.
- Evans, K. (1987). The Interactions of Potato Cyst Nematodes and *Verticillium dahliae* on early and main Crop Potato Cultivars. *Annals of Applied Biology* **110**: 329-39
- Evans, K. and Haydock, P.P.J. (1993). Interactions of nematode with root-rot fungi In Nematode interactions. (Ed) Khan, M.W. Chapman and Hall, 2-6 Boundary Row, London. 104 -133pp
- Fademi, O.A. (1984) Influence of rate and time of carbofuran application to control root-knot nematodes in upland rice. *International Rice Research Newsletter* **9** (6), 22-23.
- Fademi, O.A. and B. Fawole (1992). The Biology and control of nematode pests of rice in Nigeria. In: The proceedings of the 1st Symposium on the Biology and control of Nematode pest of food crops in Africa. Fawole B., O.A. Egunjobi, S.O. Adesiyani, J.O. Babatola and A.A. Idowu (eds). University of Ibadan, Ibadan Nigeria. 26-29 July pp117-126
- FAO (2000). Championing the cause of rice. Food and Agriculture Organization (FAO) News and Highlights, April 2000. [www.fao.org/news/2000](http://www.fao.org/news/2000)
- FAO (2011). Rice market monitor. Food and Agriculture Organization (FAO), Vol. XIV – Issue No.4. <http://www.fao.org/economic/est/publications/rice-publications/rice-market-monitor>.
- Fawole B. (1988). Histopathology of Root-knot nematode (*Meloidogyne incognita*) infection on White yam (*Dioscorea rotundata*) tubers. *Journal of Nematology* **20** (1):23-28
- Fawole, B. and Raji, M.A. (1988) Relationship between numbers of *H. sacchari* cysts and upland rice growth and development. *Test of Agrochemicals and Cultivars 9 (Ann. Appl. Biol.* **112**, Supplement): 108-109.
- Ferraz, L.C.C.B. (1995) Danos causados a duas variedades de arroz pelonematoide das galhas *Meloidogyne javanica*. *Summa Phytopathologica* **21**, 36-37.

- Fichtner, S.M., Isakeit, T., Wheeler, T.A., Kaufman, H.W. and Gannaaway, J.R. (2005) Evaluation of several approaches to management of *Meloidogyne incognita* and cotton seedling disease complexes in the high plains of Texas. *Journal of Nematology* **37**, 66-70
- Fortuner, R. and Merny, G. (1973) Les nématodes parasite des racines associés au riz en Basse-Casamance et en Gambie. Cahiers de l'ORSTOM, *Serie Biologie* **21**, 3- 20
- Fortuner, R. and Merny, G. (1979) Root-parasitic nematodes of rice. *Revue de Nématologie* **2**, 79-102.
- Francl, L. J. and Wheeler, T. A. (1993). Interactions of plant- parasitic nematodes with wilt- inducing fungi: In Nematode interactions. (Ed) Khan, M.W. Chapman and Hall, 2-6 Boundary Row, London. 79-103pp
- Gao, X., Jackson, T.A., Hartman, G.L. and Niblack, T.L. (2006). Interactions Between the Soybean Cyst Nematode and *Fusarium solani* f.sp. *glycines* Based on Greenhouse Factorial Experiments. *Phytopathology* **96**: 1409-1415.
- Gipson, I.K.S., Kim, and R.D. Riggs (1971) Ultrastructure of early development of syncytium by *Heterodera glycines* in roots of soybeans. *Phytopathology* **59**: 1027-1028 (Abstr.)
- Gomez, K.A. and Gomez, A.A. (1984) Statistical procedures for Agricultural research. Second edition. New York, NY, USA, John Wiley and Sons Inc., 680pp.
- Gottlieb, D. (1976). Production and Role of antibiotics in Soil. *Journal of Antibiotics* **29**: 987-1000.
- Hajihassani, A., Maafi, Z.T., Ahmadi, A. and Taji, M. (2011). Survey and Biology of Cereal Cyst Nematode, *Heterodera latipons*, in Rain-fed Wheat in Markazi Province, Iran. *International Journal of Agriculture and Biology*. 13-4-576-580. <http://www.fspublishers.org>
- Hajihassani, M. and Hajihassani, A. (2010). Tolerance Limit of Winter Wheat to Cereal Cyst Nematode, *Heterodera filipjevi*, in Pot trials in Iran *Plant Protection Journal* **2**(1): 69-77
- Holtmann, B., Kleine, M. and E M. W. Grundler, E. M. W (2000). Ultrastructure and anatomy of nematode-induced syncytia in roots of susceptible and resistant sugar beet *Protoplasma* **211**: 39-50
- Hooper, D. J. (1986). Extraction of free living stages from soil. In *Laboratory Methods for Work with Plant and Soil Nematodes*, pp. 5-30 (Ed J. F. Southey) Reference Book 402, Ministry of Agriculture, Fisheries and Food. London. Her Majesty's Stationary Office, London.

- Huang, C.S. (1985). Formation, Anatomy and Physiology of giant cells induced by Root-knot nematodes pp 155-164. In Advanced Treatise on *Meloidogyne* Vol 1: Biology and Control, J.N. Sasser and C.C. Carter (eds). North Carolina State University and USAID.
- Huang, C.S. and A.R. Magenti (1969). Mitotic aberrations and nuclear changes of developing giant cells in *Vicia faba* caused by root-knot nematode, *Meloidogyne javanica*. *Phytopathology* **59**: 447-455.
- Hunt, D.J., Luc, M. and Manzanilla-López, R.H. (2005) Identification, Morphology and Biology of Plant Parasitic Nematodes: pp 40-41, In Plant Parasitic Nematodes in Subtropical and Tropical Agriculture. (Eds) Luc, M., Sikora, R.A. and Bridge, J. Wallingford, U.K., CAB International.
- Hussey, R.S. (1985). Host-parasite relationship and associated physiological changes. pp 143-153. In: Advanced Treatise on *Meloidogyne* Vol. 1: Biology and control, J.N.Sasser and C.C.Carter (eds). North carolina state University and USAID.
- Ibrahim, I.K.A., Ibrahim, I.A. and Rezk, M.A. (1972) Pathogenicity of certain nematodes on rice *Alexandria Journal of Agricultural Research* **20**, 175-181.
- Ibrahim, S.K. and Perry, R.N., Plowright, R.A. and Rowe, J. (1993) Hatching behaviour of the rice cyst nematodes *Heterodera sacchari* and *H. orydicola* in relation to age of host plant. *Fundamental and Applied Nematology* **16**, 23-29
- International Rice Research Institute (IRRI) (2000) Pathogenicity of cyst nematode, *Heterodera sacchari* on rice in sand and clay soil; *International Rice Research Notes*. **25**: 17-18
- Jaritz, G. (1972). Standort und Futterproduktion in Nord-Tunesiens. *Fortschr. Geol. Rheinlnd. Wesf.*, **2**: 279-288
- Jatala, P. and Jensen, H.J. (1976). Histopathology of *Beta vulgaris* to Individual Concomitant infections by *Meloidogyne hapla* and *Heterodera schachtii*. *J. Nematol.* **8** (4): 336-341
- Jayaprakash, A. and Rao, Y.S. (1982) Hatching behaviour of the cyst nematode, *Heterodera orydicola*. *Indian Journal of Nematology* **13**, 400-402
- Jayaprakash, A. and Rao, Y.S. (1984) Cyst nematode, *Heterodera orydicola* and seedling blight fungus *Sclerotium rolfsii* disease complex in rice. *Indian Journal of Nematology* **14**, 58-59.

- Jonathan, E.I. and Velayuthan, B. (1987) Evaluation of yield loss due to rice root nematode *Hirschmanniella oryzae*. *International Nematology Network Newsletter* **4**, 8-9.
- Jones, J.T. and Perry, N.P. (2004). Plant-parasitic Nematodes-small animals, Big Impact. *Biologist* **51** (3)
- Jones, M.G.K. and V.H. Dropkin (1975). Cellular alterations induced in soybean roots by three endoparasitic nematodes. *Physiol.Plant Pathol.* **5**:119-124
- Jorgenson, E.C. (1970). Antagonistic Interaction of *Heterodera schachtii* (Schmidt) and *Fusarium oxysporum* (Woll.) on Sugarbeets. *Journal of Nematology* **2**: 393-8
- Khan, M.W. (1993). Mechanisms of interactions between nematodes and other plant pathogens: In Nematode interactions. (Ed) Khan, M.W. Chapman and Hall, 2-6 Boundary Row, London. 55-72pp
- Krausz, J. (1994). *Oryza sativa*, rice disease description.  
[http://www.agridept.gov.lk/Techinformations/Rice/Ri\\_dise.htm](http://www.agridept.gov.lk/Techinformations/Rice/Ri_dise.htm)
- Kumari, U. and Kuriyan, K.J. (1981) Cyst nematode, *Heterodera oryzicola*, on rice in Kerala. I. Estimation of loss in rice due to *H. oryzicola* infestation, in field conditions. *Indian Journal of Nematology* **11**, 106.
- Kunz, R. (2007). Control of Post Harvest Disease (*Botryodiplodia* sp.) of *Rambutan* and *Annona* species by using a bio- control agent (*Trichoderma* sp.). pp48. The Industrial Technology Institute – Sri Lanka. ITI.  
<http://www.iti.lk/Divisions/institute.html>.
- Lamberti, F., Ciancio, A., Tuopay, D.K., Boiboi, J.B., Vovlas, N., Bleve-Zacheo, T. and Elia, F. (1991) Nematode threats to rice in Liberia. *Nematologia Mediterranea* **19**, 291-303
- Lee, Y.B. and Park, J.S. (1975) Influence of rice nematode (*Hirschmanniella oryzae*) on the root browning of rice. *Journal of Plant Protection* **14**, 35-36.
- Lopez, R. (1984) *Meloidogyne salasi* sp.n. (Nematoda: Meloidogynidae), a new parasite of rice (*Oryza sativa* L.) from Costa Rica and Panama. *Turrialba* **34**, 275-286.
- Loveys, R.R and A.F Bird (1973). The Influence of nematodes on Photosynthesis in tomato Plants. *Physiological Plant Pathology* **3**: 525 – 529
- Luc, M. and Merny, G. (1963). *Heterodera sacchari* n. sp. (Nematoda: Tylenchoidea) parasite de la canne à sucre au Congo-Brazzaville. *Nematologica* **9**, 31-37

- Luc, M. and Taylor, D.P. (1977). *Heterodera oryzae* C.I.H. Descriptions of Plant-parasitic Nematodes. Set 7, No. 91. Commonwealth. Agric. Bur. 1977. 4pp
- Manzanilla-López, R.H and Starr, J.L. (2009) Interactions with Other Pathogens. In: Root-Knot Nematodes. Eds; Perry, R.N, Moens, M and Starr, J.L. CAB International, Wallingford, Oxfordshire OX10 8DE, UK. 488pp.
- Manzanilla-López, R.H., Evans, K. and Bridge, J. (2004) Plant Diseases Caused by Nematodes. In: Nematology, Advances and Perspectives; In: Nematode Management and Utilization. Eds: Chen, Z.X., Chen, S.Y. and Dicken, D.W. Vol.2, CABI Publishing, UK. 637-703pp
- Martin, M.J., Riedel, R.M. and Rowe, R.C. (1982). *Verticillium dahliae* and *Pratylenchus penetrans*: Interactions in Early Dying Complex of Potato in Ohio. *Phytopathology* **72**: 640-4
- McLean, K.S. and Lawrence, G.W. (1993). Interrelationship of *Heterodera glycines* and *Fusarium solani* in Sudden-death Syndrome of Soybean. *Journal of Nematology* **25**: 434-9
- Melakeberhan, H. (2004). Physiology, Interactions between Nematodes and Their Host Plants; In Nematology, Advances and Perspectives: Nematode Management and Utilization. Eds: Chen, Z.X., Chen, S.Y. and Dicken, D.W. Vol.2, CABI Publishing, UK. 771-786pp
- Melakeberhan, H. and Ferris, H. (1988) Growth and Energy demand of *Meloidogyne incognita* in susceptible and resistant *Vitis vinifera* cultivars. *Journal of Nematology* **20**: 545-554
- Merny, G. (1970) Les nématodes phytoparasites des rizieres inondées en Côte d'Ivoire. I. Les espèces observees. Cahiers de l'ORSTOM, *Serie Biologie* **11**, 3- 43.
- Moldenhauer, K and Slaton, N. (2003). Rice Growth and Development. In Rice Production Handbook (Ed) Slaton, N.A. Cooperative Extension Service, University of Arkansas Print Media Center, Little Rock, pp 7 – 30
- Moorman, G.W., Huang, J.S. and Powell, N.T. (1980) Localized influence of *Meloidogyne incognita* on Fusarium wilt resistance of flue-cured tobacco. *Phytopathology* **70**, 969-970.
- MS Excel (2003) www. Microsoft Xp professional, Microsoft Corporation. U.S.A.
- Nakajima, T., Mitsueda, T. and Charchar, M.J.D. (1996). First Occurrence of Sudden Death Syndrome of Soybean in Brazil. *Japan Agricultural Research Quarterly* **30**: 31-4

- Nordmeyer, D. and Sikora, R.A.(1983). Studies on Interaction between *Heterodera daverti*, *Fusarium avenaceum* and *F. oxysporum* on *Trifolium subterraneum*. *Revue Nematol.* **6**(2): 193-198
- Nwauzor, E.C (1982). Identification, biology and control of root-knot nematodes (*Meloidogyne* spp) on edible yams (*Dioscorea* spp.) in Eastern Nigeria. Ph.D Thesis, Dept. of Agric. Biology, University of Ibadan, Nigeria. 233pp
- Nwauzor, E.C and J.O Ihediwa (1992). Screening of cassava varieties for resistance to Root knot nematodes Pp. 229- 234. In proceedings of the 1<sup>st</sup> Regional Symposium on the Biology and control of Nematode pests of food crops in Africa. B. Fawole, O.A Egunjobi, S.O. Adesiyun, J.O. Babatola and A.A. Idowu (Eds) Hiswill InfoResources Management Limited, Ibadan.
- Oikeh, S.O., Nwilene, F.E., Agunbiade, T.A., Oladimeji, O., Ajayi, O., Semon, M., Tsunematsu, H. and Samejima, H. (2008). Growing upland rice: a production: Handbook; Africe Rice Center (WARDA). Pp44
- Okada, T. (1955) On morphological characters of upland rice nematode, *Heterodera* sp. *Annual Meeting of the Japanese Society of Applied Entomology and Zoology* **11**, 137-141
- Onwueme, I.C. and T.D. Sinha (1991). Field Crop Poduction in Tropical Africa, Principle and Practice, pp 200-207. Published; T.A, Ede, The Netherlands
- Onyeka, T.J. (2002). Cassava root rot fungi in Nigeria: Variability in *B. theobromae* isolates and Evaluation of cassava germplasm for root rot resistance. Ph.D Thesis; Department of Crop Protection and Environmental Biology, Faculty of Agriculture, University of Ibadan, Nigeria. 168pp
- Osai, E.O. and Ikotun, T. (1993). Micro-organisms associated with cassava ministem rot. *International Journal of Tropical Plant Disease.* **11**: 161-166
- Osai, E.O., Ikotun, T., Asiedu, R. and Hahn, S.K. (1996). Susceptibility of yam cultivars to minisett rot pathogens. *Journal of Trop. Sci.* **36**: 201-205
- Ou, S.H. (1984). Rice disease. CAB International, Farnham House Second Edition 356pp
- Oyetunji, O.E. (2009). Evaluation of Fungi- termite interaction on three rice (*Oryza* spp. Linn) varieties grown on ultisol soil.M.Sc Project; Department of Botany and Microbiology, Faculty of Science, University of Ibadan, Nigeria. 62pp
- Page, S.L.J. and Bridge, J. (1978) Plant Nematodes on Deep Water Rice in Bangladesh. *Report on Visit to Bangladesh. Ministry of Overseas Development, London, UK. Overseas Development Administration, 48 p.*

- Plowright, R.A., Coyne, D.L., Nash, P and Jones, M.P. (1999) Resistance to the rice nematodes *Heterodera sacchari*, *Meloidogyne graminicola* and *M. incognita* in *Oryza glaberrima* and *O. glaberrima* x *O. sativa* interspecific hybrids. *Nematology* **1**, 745-751
- Powell, N.T and Nasbaum, C.J. (1960) The black shank-root knot complex in flue cured tobacco. *Phytopathology* **50**, 899-906.
- Powell, N.T. (1971). Interactions between Nematodes and Fungi in Disease Complexes. *A. Rev. Phytopathology*, **9**:253-274
- Powell, N.T., Melendez, P.L. and Batten, C. K. (1971) Disease complexes in tobacco involving *Meloidogyne incognita* and certain soil-borne fungi. *Phytopathology* **61**, 1332-1337
- Prot, J. (1993). Biochemical and Genetic basis of Fungus-nematode Interactions. In: Nematode Interactions ed. Khan, M.W. Chapman and Hall. 288pp
- Ramana, K.V. and Rao, U.S. (1978) Evaluation of yield losses due to lance nematode, *Hoplolaimus indicus* Sher in rice. *Andhra Agriculture Journal* **24**, 124-125.
- Rao, Y.S. and Biswas, H. (1973) Evaluation of yield losses in rice due to the root-knot nematode *Meloidogyne incognita*. *Indian Journal of Nematology* **3**, 74
- Rao, Y.S., Prasad, J.S and Panwar, M.S. (1986) Nematode problems in rice: crop losses, symptomatology and management In: Swarup, G. and Dasgupta, D.R. (eds) *Plant Parasitic Nematodes of India. Problems and Progress*. Indian Agricultural Institute, New Delhi, pp. 279-299.
- Reversat, G. (1975) Etude préliminaire de la survie en anadrobiose des juveniles du nématode *Heterodera oryzae* (Tylenchida: Heteroderidae). *Comptes Rendus de l' Académie des Sciences, Paris Série D* **280**, 2865-2868.
- Reversat, G. and Destombes, D. (1998) Screening for resistance to *Heterodera sacchari* in the two cultivated rice species, *O. sativa* and *O. glaberrima*. *Fundamental and Applied Nematology* **21**, 307-317
- Richards, B.N. (1976). *Introduction to the Soil Ecosystem*. London, UK: Longman. 480pp
- Rupe, J.C. (1989). Frequency and Pathogenicity of *Fusarium solani* recovered from Soybeans with Sudden-death syndrome. *Plant Disease* **73**: 581-4.
- Rupe, J.C., Sabbe, W.E., Robbins, R.T. and Gbur, E.E. (1993). Soil and Plant Factors Associated with Sudden-death syndrome of Soybean. *Journal of Production Agriculture* **6**: 218-21

- Saeedizadeh, A., Kheiri, A., Okhovat, M. and Hoseininejad, A. (2003). Study on interaction between root-knot nematode *Meloidogyne javanica* and wilt fungus *Verticillium dahliae* on olive seedlings in greenhouse. *Commun Agric Appl Biol Sci.* **68**: 139-143.
- Salawu, E.O. (1986) The biology and Host parasite relations of the sugarcane cyst nematode, *Heterodera sacchari.*, Ph.D. Thesis, University of Ibadan, 107 p
- Salawu, E.O. (1992) Reaction of sugarcane hybrids to the sugar cyst nematode, *Heterodera sacchari*: In Proceedings of the first regional symposium on the biology and control of nematode pest of food crops in Africa. Eds. Fawole, B., Egunjobi, O.A., Adesiyun, S.O. and Idowu, A.A. *African Society of Nematologists*, Pp 209-216
- Sancho, C.L., Salazar, L. and Lopez, R. (1987) Efecto de la densidad inicial del inoculo sobre la patogenicidad de *Meloidogyne salasi* en arroz. *Agronomia Mesoamericana* **10**, 103-105.
- SAS Institute (2002). SAS User's Guide: Statistics, version 9.1e SAS Institute, Cary. NC. USA.
- Scardaci, S.C., Webster, R.K., Greer, C.A., Hill, J.E., Williams, J.F., Mutters, R.G., Brandon, D.M., McKenzie, K.S. and Oster, J.J. (2003). Rice Blast: A New Disease in California Agronomy fact sheet series 1997-2 Department of Agronomy and Range Science, University of California, Davis: <http://www.Plantsciences.ucdavis.edu/uccerice/afs/agfs0297.htm>
- Semagn, K., Ndjiondjop, M.N., Lorieux, M., Cissoko, M., Jones, M. and McCouch, S. (2007). Molecular profiling of an interspecific rice population derived from a cross between WAB 56-104 (*Oryza sativa*) and CG14 (*Oryza glaberrima*). *African Journal of Biotechnology*, **6**: 2014-2022.
- Sembdner, G. (1963). Anatomie der *Heterodera rostochiensis* gallen an Tomatenwurzeln. *Nematologica* **9**: 55-64.
- Sharma, S.B. and Swarup, G. (1985) *Cyst Forming Nematodes of India*. Cosmo publications, New Delhi. 440pp
- Sharma, S.B., Pande, S., Saha, M., Kaushal, K.K., Lal, M., Singh, M., Pokharel, R., Upreti, R.P. and Singh, K. (2001) Plant parasitic nematode associated with rice and wheat based cropping systems in Nepal. *International Journal of Nematology* **7**, 49-57.
- Sharma, S.N., Sain, R.S., Mathur, B.N., G.L. Sharma, G.L., Bhatnagar, V.K., H. Singh, H. and Midha, R.L. (2007) Development and validation of the first cereal cyst



- nematode (*Heterodera avenae*) resistant wheat CCNRV 1 for Northern India. *SABRAO Journal of Breeding and Genetics*: **39**(1) 1-16, 2007
- Sidhu, G.S. and Webster, J.M. (1977) the use of amino acid fungal auxotrophs to study the predisposition phenomena in the root-knot wilt fungus disease complex of tomato. *Physiological Plant Pathology*, **11**, 117-127
- Sikora, R.A. (1977). *Heterodera trifolli* associated with *Fusarium* root-rot of *Trifolium subterraneum* in Northern Tunisia. *Nematol. Medit.*, **5**: 319-32.
- Starr, J.L. and Martyn, R.D. (1991) Reaction of cotton cultivars to *Fusarium* wilt and root-knot nematodes. *Nematropica* **21**, 51-58.
- Stone, A.R. (1973). *Heterodera pallida*. C.I.H. Descriptions of Plant-parasitic Nematodes. Set 2, No. 17. Commonw. Agric. Bur. 1973, 2pp
- Stone, A.R. and Course, J.A. (1974). *Heterodera goettingiana* C.I.H Descriptions of Plant-parasitic Nematodes. Set. 4, No. 47, Commonwealth Agric. Bur. 1974. 4pp.
- Storey, G.W and Evans, K. (1987). Interactions between *Globodera pallida* juveniles, *Verticillium dahliae* and three potato Cultivars, with Descriptions of associated histopathologies. *Plant Pathology* **36**: 192-200
- Taylor, A.L. and Sasser, J.N. (1978). Biology, Identification and Control of Root-knot Nematode, *Meloidogyne* Species. North Carolina State University Graphic. Raleigh. 111pp
- Thorne, G. (1961). Principles of Nematology. Mcgraw Hill Book Company, Inc. N.Y. Toronto, London. 533 pp.
- USDA (2008) United States Department of Agriculture (USDA) Economic Research Service: <http://www.ers.usda.gov/Briefing/Rice/>
- Vovlas, N. and Inserra, R.N. (1983). Biology of *Heterodera mediterranea*. *Journal of Nematology* **15**(4): 571-576.
- Wallace, H.R. (1974). The influence of root-knot nematode, *Meloidogyne javanica*, on photosynthesis and nutrient demand by roots of tomato plants. *Nematologica* **20**: 27-33.
- WARDA (1999). West African Rice Development Association Annual Report. *International Rice Commission Newsletter* (2002). Vol. 50, 1-4pp.
- WARDA (2005) Rice trends in Sub-Saharan Africa, Africa Rice Center. Third edition, Bouaké, Côte d'Ivoire, 34pp

- WARDA (2008a) Africa Rice Trends 2007. Cotonou, Benin: Africa Rice Center (WARDA). Fifth edition; (eds) Aliou Diagne, Ibrahima Bamba, Ali A. Touré and Achille Medagbe. 84 pp
- WARDA (2008b). NERICA ®: the New Rice for Africa- a compendium. E.A. Somado, R.G. Guei and S.O. Keya (eds.). Cotonou, Benin, 195pp
- Webster, J. and Weber, R.W.S. (2007). Introduction to Fungi, Third Edition, Cambridge Univ. press. 841pp.
- Williams, T.D. and Siddiqi, M.R. (1972). *Heterodera avena* C.I.H. Descriptions of Plant-parasitic Nematodes. Set 1, No. 2. Commonwealth Agric. Bur. 4pp.
- Williamson, V.M. and Gleason, C.A. (2003). Plant-nematode Interactions, *Current Opinion in Plant Biology*. Elsevier **6**: 327-333.
- Xing, L. and Westphal, A. (2006) Interaction of *Fusarium solani* f.sp. *glycines* and *Heterodera glycines* in Sudden Death Syndrome of Soybean. *Phytopathology* (Ecology and Epidemiology): **96** No. 7, 2006

**Appendix 1:**

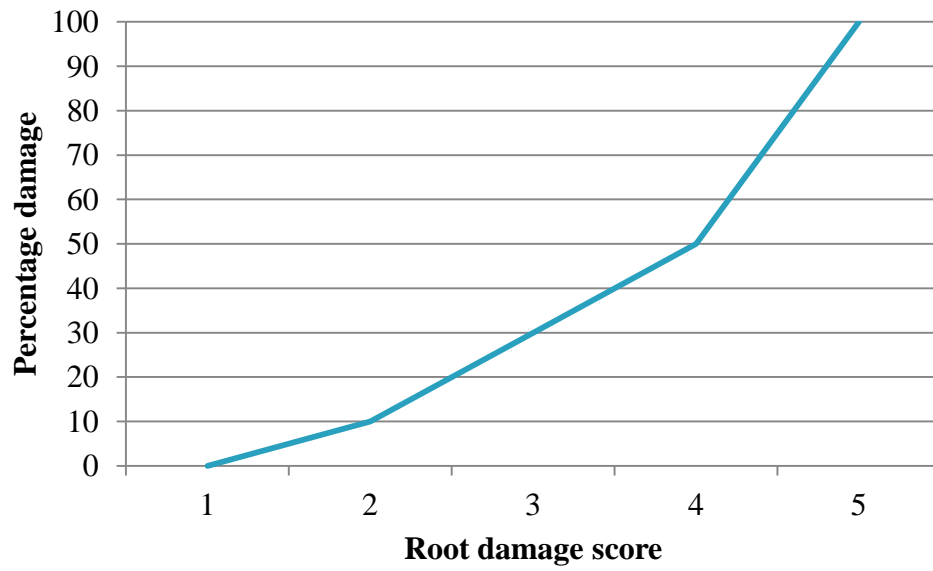

Appendix 1: Damage score of *H. sacchari* on rice roots in relation to percentage damage.