

**ASSESSMENT OF DETRIMENTAL HEALTH EFFECT OF
RADIATION ASSOCIATED WITH DIAGNOSTIC X-RAY
EXAMINATIONS AT FOUR CENTRES IN NIGERIA**

BY

BIDEMI IDAYAT AKINLADE

**B.Sc., M.Sc. (Ibadan)
58458**

**A THESIS IN THE DEPARTMENT OF PHYSICS
SUBMITTED TO THE FACULTY OF SCIENCE IN
PARTIAL FULFILMENT OF THE REQUIREMENTS FOR
THE DEGREE OF DOCTOR OF PHILOSOPHY (PhD) OF
THE UNIVERSITY OF IBADAN**

JUNE, 2011.

DEDICATION

This work is dedicated to

GOD the father, the fountain of my life;

Jesus Christ, the author and finisher of my faith; and

The Holy Spirit, my guidance and comforter.

UNIVERSITY OF IBADAN

ABSTRACT

Radiation exposure during diagnostic X-ray examinations has been widely reported as one of the sources of cancer induction. Information on X-ray machine and exposure parameters are crucial to risk assessment, which in turn are important for optimization of radiation protection measures. The documentation of radiation risk in Nigeria is sparse and hence the effectiveness of radiation protection measures at diagnostic centres has not been well established. This work was aimed at measuring effective dose received by patients during diagnostic x-ray examinations and estimating the associated risk.

Between the years 2004 and 2006, the beam output of x-ray machines at four diagnostic centres with adequate regulatory activities were measured with non-invasive x-ray meter. These centres include University College Hospital (UCH) Ibadan, Twotees Diagnostic Centre (TDC) Ibadan, Obafemi Awolowo University Teaching Hospital Complex (OAUTHC) Ile-Ife and National Hospital Abuja (NHA). Field sizes, focus to skin distance (FSD), tube filtration, operating potential (kVp) and tube loading (mAs) were measured and used to calculate Dose Area Product (DAP) per patient. Data on age and examination type were recorded for 1034 patients which include 310(UCH), 276(TDC), 220(OAUTHC) and 228(NHA). These and calculated DAP were used to run Monte Carlo program to obtain effective dose. The risk of cancer was thereafter estimated using fatal cancer risk factor of $5 \times 10^{-2} \text{ Sv}^{-1}$. The results obtained were compared with the risk estimates recommended by the International Commission on Radiological Protection (ICRP).

X-ray field sizes and FSD of the examinations considered ranged from 8 cm x 5 cm to 40 cm x 35 cm and 75 cm to 139 cm respectively. The tube filtrations (mmAl) at UCH, TDC, OAUTHC and NHA were 1.7, 2.7, 1.7 and 1.0 +1.0 mmCu respectively while the mean exposure parameters (kVp, mAs) were 69, 45; 76, 79; 100, 83; and 75, 28 respectively. Analysis of examination type showed that thoracic x-ray examination was the most common (74.0%). This was followed by head and neck (11.0%), pelvic (8.0%), lower limb (4.0%), abdomen (2.0%) and upper limb (1.0%). The mean age (years) of patients was 38±1 at UCH, 32±1 at TDC, 27±1 at OAUTHC and 28±1 at NHA. Examination procedures were the same in all centres except the use of anti-scatter grid for thoracic examination at OAUTHC. In all x-ray examinations, DAP (mGycm²) generally ranged from 70 to 38,155. The range of effective doses (mSv) at UCH, TDC, OAUTHC and NHA were 0.01–0.11, 0.01–0.17, 0.24–4.74 and 0.01–0.10 respectively while the corresponding estimated risks of cancer per million were 2–9, 2–22, 100–400 and 2-6. The values at OAUTHC were higher than ICRP risk estimates of 35 cancer cases per million. This was traceable to selection of high kVp with high mAs and insufficient tube filtration.

Radiation risks associated with diagnostic X-ray examinations were within acceptable limit except at OAUTHC. For radiation risks to be within the recommended limit, the use of high kVp with low mAs and careful application of anti-scatter grid are encouraged.

Keywords: Patient dose, Cancer risk assessment, Ionising radiation, Effective dose, Diagnostic x-ray examinations.

Word count: 495

ACKNOWLEDGEMENT

First and foremost, my sincere appreciation goes to the Almighty God for His Mercies and Grace, which were readily available for me throughout the course of this study.

I am grateful to my Supervisor and Mentor, Prof. I. P. Farai, for his perseverance, articulate suggestions and thorough supervision of this work. I thank the post graduate Coordinator, Dr. F. O. Ogundare, and his team for their contributions towards the progress of this study. I am also grateful to the Secretaries of the Departments of Physics and the National Institute of Radiation Protection and Research (NIRPR) for their assistances in time of need. To the Director of NIRPR, Prof. F. B. Balogun, who gave me opportunity to use their computer facility, especially when there was no power supply in the Departmental main building, I say thank you Sir.

I am sincerely grateful to the International Atomic Energy Agency, IAEA, Vienna Austria and International Centre for Theoretical Physics, ICTP, Trieste Italy, for their sponsorships in International training workshops especially, the workshop on Radiation Protection in Diagnostic and Interventional Radiology, Nairobi Kenya (2004), which actually gave birth to this research study. I am particularly grateful to one of the resource persons at this workshop, Dr Jenia Vassileva from the Laboratory for Quality Control, National Centre of Radiobiology and Radiation Protection, Sofia, Bulgaria. She introduced me to Monte Carlo program, PCXMC, and paid for license to access the program.

My appreciation goes to my parents, Mr. and Mrs Adejare Oduola, for giving me basic education despite their meager income and up till date still have interest in my academic progress. I also appreciate the co-operation of all the patients, radiographers and the managements of all the centres selected for this study. To my Pastors, Relations, Colleagues and those who have in one way or the other contributed to the success of this program, I say thank you and God bless you richly.

Finally, I would like to appreciate my dearest husband and wonderful children for their understanding, moral support and prayers throughout the period of this work.

UNIVERSITY OF IBADAN

CERTIFICATION

I certify that the work described in this thesis was carried by Bidemi Idayat Akinlade under my supervision in the Department of Physics, University of Ibadan, Ibadan.

.....
(Supervisor)

I. P. Farai

Professor of Physics

B.Sc. (Nig), M.Sc., PhD (Ibadan)

Department of Physics

University of Ibadan, Ibadan, Nigeria.

TABLE OF CONTENTS

Title	Page
Title Page	i
Dedication	ii
Abstract	iii
Acknowledgement	v
Certification	vii
Table of contents	viii
List of Figures	xiv
List of Tables	xvi
CHAPTER ONE: INTRODUCTION	
1.1 Background	1
1.2 Biological and Health Effects of Radiation	2
1.2.1 Stochastic effects	3
1.2.2 Deterministic effects	3
1.2.3 Acute Radiation Syndrome (ARS)	5
1.2.4 Cancer induction	5
1.3 Risk of Medical Diagnostic x-ray Examinations	7
1.4.1 Monte Carlo Calculation	9
1.4.2 Dose Area Product, DAP	10
1.4.3 Effective Dose, E	11
1.5 Radiation Detriment	12

1.6	Need for Radiation Protection	16
1.7	Cancer Incidence in Nigeria	17
1.8	Current Status of Radiological Practices in Nigeria	18
1.9	Justification of this Study	20
1.9.1	Aims and Objectives	21

CHAPTER TWO: LITERATURE REVIEW

2.1	Medical Diagnostic X-ray Techniques	22
2.1.1	Fluoroscopy (Interventional Radiology)	22
2.1.2	Computed Tomography (CT)	25
2.1.3	Mammography	29
2.1.4	Film/Conventional Radiography (CR)	32
2.2	Characteristics of Images produced in Diagnostic X-ray Techniques	35
2.2.1	Contrast	37
2.2.2	Blur and Visibility of Detail	39
2.2.3	Sharpness	40
2.2.4	Noise	40
2.2.5	Resolution	40
2.2.6	Artifacts	41
2.2.7	Distortion	41
2.3	Factors Affecting patient's Dose in Diagnostic X-ray Imaging Techniques	42
2.3.1	Beam Effective Energy	43

2.3.2	Beam Filtration	45
2.3.3	Collimation	48
2.3.4	Anti-Scatter Grids	48
2.3.5	Size of the patient	49
2.3.6	Film-Screen Combination	49
2.3.7	Film Processing Condition	50
2.3.8	Focus-Skin Distance, FSD	51
2.3.9	X-ray Tube Target Material	51
2.4	Radiation Dose to Patient and its Associated Risk	51
2.4.1	Radiation Risk Modeling	52
2.4.2	Linearity versus Curvi-linearity of Dose-effects relationship	53
2.4.3	Linear Non Threshold Dose Model (LNT)	53
2.4.4	Controversy about LNT model	54
2.5	Radiation Risk Quantities	55
2.6	Radiation Risk Estimates	55
2.7	Determination of radiation dose to organs and effective dose from radiation exposure	58
2.7.1	The use of Conversion Coefficients' Charts	58
2.7.2	Direct Dose Measurements within a Rando Anthropomorphic Phantom	59
2.7.3	The use of Software Program, XDOSE	61
2.7.4	Estimation from imparted radiation Energy	60
2.7.5	The use of Dose Area Product (DAP) meter	60

2.7.6	The use of Computer Model	60
2.7.7	The use of Personnel Radiation Dose Calculation (PRDC)	60
2.7.8	The use of the quantity, Dose Area Product, DAP	61
2.7.9	The use of Monte Carlo (MC) based Simulation	61
2.8.	Monte Carlo (MC) Theory	62
2.8.1	Monte Carlo (MC) Simulation	64
2.8.2	Monte Carlo Algorithm	67
2.8.3	Personal Computer X-Ray Monte Carlo (PCXMC) Program, Version 1.5	68

CHAPTER THREE: MATERIALS AND METHOD

3.1	Introduction	71
3.2	Selection of Diagnostic Centres	71
3.2.1	Radiology Department, University College Hospital (UCH), Ibadan	72
3.2.2	TwoTees Diagnostic X-ray Centre (TDC), Yemetu Ibadan	73
3.2.3	Department of Radiology, Obafemi Awolowo University Teaching Hospital Complex (OAUTHC), Ile-Ife	74
3.2.4	Department of Radiology, National Hospital Abuja (NHA)	75
3.3	Radiographic Technical data of x-ray machines	76
3.4	X-ray Exposure Parameters	78
3.4.1	Tube Voltage, kV	78
3.4.2	Tube Loading, mAs	78

3.4.3	Time, seconds	78
3.5	X-Ray Beam Quality and Radiation Output Measurements	79
3.5.1	Quality control of film processor	80
3.6	Dose Area Product, DAP	81
3.7	Computation of organ doses using PCXMC software program	82
3.8	Estimation of the Risk of Cancer	91

CHAPTER FOUR: RESULTS

4.1	X-ray Beam Output Measurements	92
4.2	Demographic Data for patients	92
4.3	Areas of the body that undergone X-ray Examination	92
4.4	X-ray Exposure Parameters	100
4.5	Application of Anti-scatter grids	100
4.6	Film Rejection Analysis	100
4.7	Calculated Dose Area Product (DAP)	104
4.8	Measured Entrance Skin Dose (ESD)	104
4.8.1	Measured Organs doses and Effective dose	104
4.8.2	Estimated (per million) risk of fatal cancer from different x-ray examination at the centers considered in this study	110
4.8.3	Frequency distribution of measured quantities per centre	110
4.9	X-ray room layout	110

CHAPTER FIVE: DISCUSSION

5.1	Radiographic Technical Data	131
5.1.1	X-ray machine	131
5.1.2	X-ray room design	132
5.2	X-ray Beam Output	139
5.3	Demographic information of patient	136
5.4	Area of the body that undergone x-ray examination	136
5.5	X-ray Exposure Parameters	137
5.6	Application of anti-scatter grids	139
5.7	Film Rejection Analysis	140
5.8	Dose Area product, DAP	141
5.9	Entrance Skin Dose (ESD)	144
5.10	Radiation doses and effective dose in various organs of patients	146
5.11	Estimated Risk of Cancer from diagnostic examinations	148
5.12	Frequency Distribution of measured quantities	150

CHAPTER SIX: CONCLUSION AND RECOMMENDATION

6.1	Conclusion	153
6.2	Recommendations	156

REFERENCES

157

LIST OF FIGURES

FIGURES	PAGE
2.1 Fluoroscopy machine with head mounted	24
2.2 Computed Tomography (CT) Machine	27
2.3 Mammography x-ray machine	31
2.4 Conventional/Film Radiography X-ray machine	34
2.5 Components Associated with the Medical Imaging Process	36
2.6 Image Contrast Process	38
2.7 Effective Energy of X-ray Spectra	44
2.8 Monte Carlo (MC) Technique	63
2.9 MC Simulation flow chart	66
3.1 The main form of PCXMC	83
3.2 X-ray examination data input form of PCXMC	86
3.3 Monte Carlo simulation window of PCXMC	88
3.4 Dose calculation window of PCXMC	90
4.1 The comparison of values of beam output obtained from centers and those fitted to eqn. (3.1) for different values of kVp	95

4.2	Bar Charts showing frequency of examination group, Age group, sex, Body Mass Index, BMI, kV group, mAs group, Dose Area Product, DAP, group, Entrance skin Dose, ESD, group, Effective dose group and Risk of Cancer for various centres	116
4.3a	A schematic diagram of x-ray room at UCH	127
4.3b	A schematic diagram of x-ray room at TDC	128
4.3c	A schematic diagram of x-ray room at OAUTHC	129
4.3d	A schematic diagram of x-ray room at NHA	130

UNIVERSITY OF IBADAN

LIST OF TABLES

TABLES	PAGES
1.1 Threshold doses for some deterministic effects of radiation	4
1.2 Nominal Probability coefficients of stochastic effects	13
1.3 Multiplication factor for risk of cancer with respect to age at exposure	14
1.4 Risk of fatal cancer with respect to age at exposure	15
2.1 Recommended minimum penetration (HVL) for various kVp values	47
2.2 Probability coefficients of cancer with respect to human tissues/organs	57
3.1 Radiographic Technical Data of x-ray machine	77
4.1 Radiation Exposure per tube loading	93
4.2 Radiation Dose per tube loading	94
4.3 Values of a_0 , a_1 , a_2 , a_3 , a_4 and regression coefficient (R^2) resulting in best-fits to equation (3.1) for the various centers	96
4.4a Demographic information of patients at various centers	97
4.4b Comparison between patient data obtained in this study with Previous works by other authors	98
4.5 Type of Radiographic examination and projection per x-ray centre	99
4.6 Average values of exposure parameters (kVp and mAs) used for different radiographic examination at various centres	101
4.7 Application of Grid (Yes or No) during radiological procedure at the centres considered in this study	102
4.8 Rejection Analysis of Radiographic films at the centres considered in this study	103

4.9.0	Dose Area Product for various radiographic examinations at various centres	105
4.9.1	Comparison between ESD (mGy) values obtained in this study with ESD from published studies	106
4.9.2	Typical organs' and effective doses calculated by PCXMC	107
4.9.3	Comparison between the values of effective dose obtained in this study with those from other studies for similar x-ray examinations	109
4.9.4	Radiation detriment associated with different radiological examination at the centers	111
4.9.5	Estimated risk of cancer associated with different radiological examination at various centers	114
4.9.6	Modal ranges of measurable quantities at the centres	115
4.9.7	Position of radiographic accessories with respect to x-ray tube/couch at the centres	126

CHAPTER ONE

INTRODUCTION

1.1 BACKGROUND

X-ray is a type of electromagnetic radiation with short wavelength and high frequency. When x-rays interact with matter, it transfers some of its energy to the atoms and consequently removes electrons from it in a process known as ionization.

Since the discovery of x-rays in 1895 by William Roentgen, x-rays have been playing vital roles in different disciplines. Soon after its discovery, x-rays line spectra were used by H. G. J. Moseley in 1913 in his work on atomic number and provided further confirmation of the quantum theory of atomic structure. Quantum theory is concerned with the emission and absorption of energy by matter.

Another important aspect of x-rays is the discovery of x-ray diffraction by Max Von Laue in the year 1912 and its subsequent application by W. H. and W. L. Bragg to the study of crystal structure. Diffraction is the bending of waves around the edge of an obstacle. The diffraction of x-ray by crystals is used to examine the atomic and molecular structure of crystals.

One of the most applications of x-rays is radiography. Radiography is the photography made with x-rays. This radiography has applications in both medicine and industry, where it is valuable for diagnosis and non destructive testing of products for defects. Radiography is also used in the examination and analysis of paintings, where study could reveal such details as the age of a painting; and underlying brush stroke techniques, which can help one to identify the unknown artist. Other notable uses of x-rays include x-ray fluorescence, airport security, x-ray photoelectron spectroscopy and others.

However, the use of x-rays is not without danger. One of the dangers in the use of x-rays is that they can destroy living tissue and can cause severe burns of human skin exposed for too long. This destructive power is used in x-ray therapy to destroy diseased cells.

Since Roentgen's discovery that x-ray can identify bone structures, x-rays have been developed for their use in medical imaging. Diagnostic imaging with x-rays is

the most common use of x-ray technology. X-rays are especially useful in the detection of pathology of the skeletal system, some disease processes in soft tissue, intestinal obstruction, gallstones, kidney stone and others.

Ionizing radiation, in the form of x-rays, has long been used in medicine both for therapy and diagnosis. However, its use is not without hazards, and it is important that the extent of any hazard is appreciated by those using it for various applications.

1.2 BIOLOGICAL AND HEALTH EFFECTS OF RADIATION

The consequence of interaction of radiation with the atom of a living cell is the basis of biological effects. The interaction of radiation with biological cells could take place directly or indirectly. The direct interaction occurs when radiation interacts with the atoms of the DNA molecules or other cellular components that are critical to the survival of the cell.

When a biological cell is exposed to radiation, the probability that the radiation would have a direct interaction with the DNA molecules is very small because the DNA molecules occupy only a small portion of the cell. The component of each biological cell is mostly water, for this reason, the probability of radiation interacting with the water that makes up the cell's volume is higher. Thus, the indirect interaction of radiation occurs when radiation interacts with water molecules of a cell and other events follow.

When radiation interacts with water molecules, it could break the bond that holds the water molecules together, producing fragments such as hydrogen (H) and hydroxyls (OH). These fragments may combine with other ions to form compounds (H₂O) which would not harm the cell. They could also combine to form toxic substances, such as hydrogen peroxide (H₂O₂), which could destroy the cell. The basic radiochemical reactions that could occur in water molecules by the passage of an ionizing radiation are as follows:

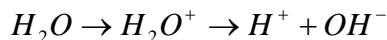
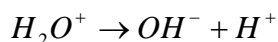
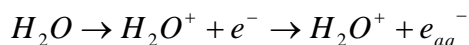

About two-third of the biological damage caused by low energy radiations, such as x-rays, is due to these indirect interactions while one-third is due to direct interaction. The biological effect of ionizing radiation is classified into two main class namely stochastic and deterministic effects. These are discussed briefly below:

1.2.1 STOCHASTIC EFFECTS

Stochastic effect of ionizing radiation is the effect that could occurs at any given radiation dose. This effect is random and probabilistic in nature. The occurrence of stochastic effect increases with increasing dose but its severity in the affected individuals does not depend on the absorbed dose. There is no threshold dose for which this effect would not occur and the effect generally occurs with a single cell. The stochastic effect is sub- divided into:

1.2.1.1 **Somatic effect**, that is, the harm that the exposed individual suffers throughout lifetime and the effect of irradiation is limited to the exposed person. Somatic effect includes radiation induced cancers, sterility, opacification of the eye lens and early death.

1.2.1.2 **Genetic effect**, that is, the effect that occurs when an individual's reproductive organs (gonads or ovary) are irradiated. Genetic effect results in radiation induced mutations in the genes and DNA of the irradiated individual. It could also make the exposed individual to give birth to defective offspring. Examples of stochastic effects are induction of cancers and genetic effects.

1.2.2 DETERMINISTIC EFFECTS

Deterministic effect of ionizing radiation has a minimum (threshold) dose below which it would not occur. The severity of occurrence of deterministic effect increases with increasing dose, usually above a particular threshold dose. This effect generally occurs with population of cells. Examples of deterministic effects are acute radiation sickness, erythema of the skin, lens opacification, impairment of fertility, fibrosis of bone marrow etc. The threshold doses for some deterministic effects are presented in Table 1.1.

Table 1.1 Threshold doses for some deterministic effects of radiation (IAEA, 2006)

Organ	Threshold dose, Gy
Cataracts of the lens of the eyes	2.0 – 10.0
Permanent sterility:	
Male	3.5 – 6.0
Female	2.5 – 6.0
Temporary sterility:	
Male	0.15
Female	0.60

The exposure of biological medium to substantial dose of ionizing radiation could lead to the following observable health effects:

1.2.3 ACUTE RADIATION SYNDROME (ARS)

ARS is a serious illness which occurs when the whole body or part of the body receives a high dose of radiation within a short period of time. Many of the survivors of the Hiroshima and Nagasaki atomic bombs in the 1940s and many of the fire fighters, the first responder in the Chernobyl Nuclear Power Plant accident in the 1986, became ill with ARS (Centre for Disease Control and Prevention, 2005).

Some of the initial symptoms of ARS are nausea, vomiting and diarrhea. These symptoms manifest within minutes to days after the exposure and could last for some minutes to several days. The chance of survival for people with ARS decreases with increasing radiation dose.

With respect to the radiation dose received, the response of an organism to acute whole body irradiation could be bone marrow syndrome ($1 \text{ Gy} < \text{dose} < 10 \text{ Gy}$); gastrointestinal syndrome ($10 \text{ Gy} < \text{dose} < 100 \text{ Gy}$); and central nervous system (CNS) syndrome ($\text{dose} > 100 \text{ Gy}$).

The radiation doses received from medical x-ray examinations, such as in conventional radiography considered in this study, are too small to produce acute radiation syndrome.

1.2.4 CANCER INDUCTION

Cancer is any malignant growth which arises from abnormal and uncontrolled cells' division. As discussed earlier, interaction of radiation with biological cells could lead to permanent impairment of DNA chromosomes or death of cells. Apart from death, cells could also undergo mutation if the damage is not severe. The mutated cells usually have some defects in them and when the mutated cells combine they form malignant growth (Hall, 1994) in the biological medium.

Ionising radiations have the ability to induce malignant growth (cancer) in biological cells and for this reasons, cancer induction is one of the risk (stochastic effect) to guard against during medical x-ray exposure (ICRU, 2005). The main consequence of radiation exposure on human health is the possibility of cancer induction in the later years of the exposed person. The manifestation of cancer in any organ of an exposed person may be delayed (late effect) for years. Some of the cancers that ionizing radiation could induce on exposed person are leukemia, bone cancer, cancer of the lung, skin, thyroid and cancer of the breast (IAEA, 2005). Malignant growth could spread from the primary site to other parts of the body through the lymphatic systems and the blood vessels.

Some of the scientific evidences of cancer induction from radiation exposure were obtained from the following studies:

(i). CONSEQUENCES OF ATOMIC BOMBING OF THE HIROSHIMA AND NAGASAKI SURVIVORS

Some of the survivors in the Hiroshima and Nagasaki atomic bombing had leukaemia and other types of cancer, several decades after their exposure to ionizing radiation (Wanebo et al, 1968).

(ii). LATE EFFECTS OF IONIZING RADIATION ON PATIENT AFTER MEDICAL TREATMENT

Many of the children, who received radiation treatment for ringworm of the scalp, enlarged thymus and skin haemangioma developed secondary cancer near the treated area several decades following radiation treatment. Similar occurrence was discovered in some adult patients who were initially treated for cancer at the primary site but developed secondary cancer at other area of their body (Noel, 1996).

(iii). WORKERS WITH HISTORY OF OCCUPATIONAL RADIATION EXPOSURE SUCH AS EARLY RADIOLOGISTS, RADIUM DIAL WORKERS AND URANIUM MINERS.

Most of the early radiation workers such as Radiologists, Radium dial workers and Uranium Miners had radiation record of very high cumulative dose and they developed cancer in their later years of life (Lubin et al, 1995).

(iv). CHILDREN PRONE TO LARGE ENVIRONMENTAL RADIATION EXPOSURES

This study reported that some of the children in the former Soviet Union, who were exposed to ionizing radiation as a consequence of the Chernobyl accident, developed cancer of the thyroid (Thompson et al, 1994).

1.3 RISK OF MEDICAL DIAGNOSTIC X-RAY EXAMINATIONS

Medical x-rays examination accounts for about 14 % of the total annual radiation exposure of population worldwide (UNSCEAR, 2000). An increment in the existing background radiation dose to an individual has been found to increase a person's cumulative risk of getting cancer (Berrington, 2004).

X-rays are relatively safe method for medical investigation and the radiation exposure during the procedure is relatively low. However, the experimental and epidemiological data do not support the proposition that there is a threshold dose of radiation below which there is no increased risk of cancer (Upton, 2003).

When patient undergoes x-ray examination for medical diagnosis purposes, millions of photons (packets of energy) pass through the body. These x-rays have potentials to damage molecules in the deoxyribonucleic acid (DNA) in the body as discussed earlier. Damage to the DNA is considered the main initiating event by which radiation causes neoplastic development. The carcinogenic effect is caused either by direct interaction with ionizing particles or through the action of free radicals or other chemical products stated in section 1.2.

There is evidence that damage to DNA molecules, caused by ionizing radiation, results in the induction of a carcinogenic process (Reactor Concepts Manual,

2009). The extent of the damage depends on the number of strand that breaks. A damaged in the DNA helix is said to be critical if a double strands break. A damaged cell could either be forced to program cell death (apoptosis) or repair itself.

However, if the repair mechanism fails such that the repair is not completed, the induction of cancer could start. The latent period between exposure to x-rays and the clinical diagnosis of cancer may be years, depending on the type of cancer involved.

The knowledge of radiation dose absorbed by an organ of patient during medical x-ray examination is essential to the evaluation of the detriment associated with the procedure, which in turn would be used to assess the net benefit from the procedure (ICRP 1990; European Commission 1997). The risk of cancer in an organs following radiation exposure is a function of the absorbed dose and the organ involved.

In medical x-ray examination, there are two fundamental reasons for estimating the patient dose. First, measurement provides a means for setting and checking standards of good practice, as an aid to optimization of radiation protection of patients and of image quality. Secondly, estimates of the absorbed doses to tissues and organs in the patient are needed to assess radiation detriment so that radiological techniques can be justified and cases of accidental over exposure investigated (ICRU, 2005).

Cancer induction is generally considered to be the main risk for patients after radiological imaging (ICRU, 2005). The quantitative approach of the risk assessment in diagnostic imaging is a complex issue than for acute effects of radiation because the concerned radiation is in the range of low doses (UNSCEAR, 2000). For determination of stochastic effect of radiation, the International Commission on Radiation Protection (ICRP, 1990) has recommended the use of mean absorbed dose to individual organs or tissues as the quantity of interest.

The current radiation protection standards and practice are based on the premise that any radiation dose, no matter how small, can result in detrimental health effects, such as cancer and genetic damage, which are both stochastic effects of ionizing radiation (Kenneth et al, 1996).

In the current European legislation (European Community Council, 1997), the quantity recommended for describing overall risk from radiation exposure is the effective dose, E. The effective dose is determined from organs' doses and organ specific radiation risk related, weighting factors. Effective dose and radiation detriment have been introduced as concepts for assessing the health impact of radiation received by more than one tissue from whole or partial body exposure to ionizing radiation. Radiation detriment can be considered as the total harm experienced by an irradiated individual. In terms of stochastic effects, this harm includes lifetime risk of fatal cancer, non-fatal cancer and hereditary effects.

In routine medical x-ray examinations, it is not practical to conduct in vivo measurements of radiation doses to about 25 organs in the body, which is required to obtain effective dose. The possible practical methods for estimating organ doses are measurements in a phantom or the use of computer calculations (Ranniko et al, 1997; Kramer et al, 1982). The most computer calculation applicable to a wide range of application is the Monte Carlo (MC) techniques (Jones and wall, 1985; Yakoumakis et al, 2001).

1.4.1 MONTE CARLO CALCULATION

In medical radiation Physics, Monte Carlo computer calculation is used to model a computer program to create virtual radiation particles and then simulate possible interactions between the particles and the medium. The particle tracks are followed from the source of radiation to their final absorption in the tissues or organs. The type of interactions that take place in the process is a function of photon energy. The prospective interactions are induced with random numbers and known probabilities of each interaction type. Several Monte Carlo packages are available for specific applications but the package used in this present study is the Personal Computer X-ray Monte Carlo (PCXMC), version 1.5 (Servomaa and Tapiovaara, 1998).

PCXMC is a computer program for calculating doses to the organs of patient and effective doses in medical x-ray examinations (fluoroscopy and radiography). The

doses are calculated in 22 different organs and tissues and the program calculates the effective dose with tissue weighting factors reported in the International Commission on Radiation Protection (ICRP) publication 60 (ICRP, 1990). The program incorporates adjustable-size pediatric and adult patient models (phantom) and allows a free choice of the x-ray examination technique. PCXMC was developed by Radiation and Nuclear Safety Authority (STUK) Helsinki, Finland (Servomaa and Tapiovaara, 1998).

The program is based on the Monte Carlo method and is simple to use. The user needs to enter the examination data with respect to the patient and x-ray machine. Some of the data input for patient include age, height and sex, while that of the x-ray machine include tube voltage, tube current, dose area product (DAP), tube filtration, field size, beam output, etc.

1.4.2 DOSE AREA PRODUCT, DAP

Dose area product is one of the major input data for the program PCXMC to calculate doses to organ and effective dose in diagnostic x-ray examination. The quantity DAP, is the product of cross-sectional area of x-ray beam that is incident on a patient and it is a measure of energy imparted to the patients during medical radiation exposure (George et al, 2006). DAP is the preferred quantity for estimating effective dose because of the ease with which it is measured in the x-ray room. Other quantity that could be used to estimate effective dose to some accuracy is the entrance skin dose (ESD) but its measurement is labor intensive.

Mathematically, DAP is expressed as:

$$DAP(mGy.cm^2) = L(mAs)D_o(mGy/mAs)A_{FSD}(cm^2) \quad (1.1)$$

where, L is the tube loading, D_o is the tube output, FSD is the Focus to Skin Distance, and A_{FSD} is the cross-sectional area of radiation beam that is incident on the skin of the patient.

1.4.3 EFFECTIVE DOSE, E (mSv)

The effective dose received by patient during medical x-ray examination is the main quantity calculated by the PCXMC program. In a whole body irradiation, the distribution of radiation doses among tissues and organs may not be uniform, therefore the equivalent dose received by various tissues and organs would be different. Also, the sensitivity of each tissue/organ to radiation damage varies. In order to account for the non-uniformity and varying sensitivity of tissue in a whole body radiation exposure, the quantity, effective dose was adopted.

The effective dose is defined as the sum of the weighted equivalent doses for all irradiated tissues and organs. The effective dose is expressed as:

$$E = \sum_T H_T W_T \quad (1.2)$$

where H_T is the mean equivalent dose received by the tissue T and W_T is the tissue weighting factor. The tissue weighting factor represents the risk (stochastic) faced by the tissue when the body is uniformly irradiated. The weighting factors for various tissues and organs were derived from the scientific data obtained from the atomic bomb survivors of Hiroshima and Nagasaki accidents (Klaus et al, 2005). The effective dose is the quantity of choice for estimating detriment from non-homogenous exposure to ionizing radiation (Jacobi, 1975).

In this study, effective dose is used as a generic indicator for classifying the health detriment from a given x-ray examination of a reference patient at different centre into broad risk categories namely low, very low, minimal and negligible as published in the British Journal of Radiology (Martin, 2007).

1.5 RADIATION DETRIMENT

Radiation detriment is defined as the total harm that a person exposed to ionizing radiation would experience in his lifetime. In view of the stochastic effects of ionizing radiation, radiation detriment includes lifetime risk of fatal cancer, non-fatal cancer and hereditary effects. The probability coefficient of each of these effects on the whole population was published in the International Commission on Radiation Protection document, ICRP Report 60 (ICRP, 1990) and is presented in Table 1.2.

Radiation detriment could be described as the risk of biological injury that an exposed person is likely to experience. The magnitude of this injury in any organ of the body depends on many factors such as radiation dose received, the type of organ, reproductive status of the exposed person, age at the time of exposure, the gender (male or female) status of the exposed person and the type of radiation (x , γ , α , n).

In order to estimate radiation detriment in an exposed individual with some accuracy, the average radiation dose absorbed by the exposed organs must be known. Radiation detriment, G , is defined by the expression:

$$G = \sum_T r_T H_T w_T \quad (1.3)$$

where r_T is the cumulative lifetime risk effect occurring in tissue T , H_T is the equivalent dose in tissue T and w_T is the weighting factor of the tissue T .

The magnitude of risk experienced by tissue depends on the specific tissue exposed to ionizing radiation, the sex (male or female) of the individual exposed and age at exposure. In terms of age at exposure, a multiplicative risk projection model averaged for both sexes has been published by the ICRP and is presented in Table 1.3.

When Tables 1.2 and 1.3 are combined, the risk of fatal cancer with respect to the age of patient at exposure is presented in Table 1.4.

Table 1.2 **Nominal Probability Coefficients of Stochastic Effects of Ionizing Radiation (ICRP, 1990)**

Cancer Type	Risk factor (x 10⁻² Sv⁻¹)
Fatal	5.0
Non-fatal	1.0
Severe hereditary	1.3
Total	7.3

Table 1.3 Multiplication factor for risk of cancer with respect to age at exposure

Age group	Multiplication factor for risk (ICRP, 1990)
< 10	3.0
10 – 20	2.0
20 – 30	1.5
40 – 50	0.5
50 – 80	0.3
80 ⁺	Negligible risk

+Beyond 80 years of age, the risk becomes negligible because the latent period between x-ray exposure and the clinical presentation of a tumour will probably exceed the life span of the patient.

Table 1.4: Risk of fatal cancer with respect to age at exposure (ICRP, 1990)

Age group	Risk of fatal cancer ($\times 10^{-2} \text{ Sv}^{-1}$)
< 10	15.0
10 – 20	10.0
20 – 30	7.5
40 – 50	2.5
50 – 80	1.5
80 ⁺	Negligible risk

+Beyond 80 years of age, the risk becomes negligible because the latent period between x-ray exposure and the clinical presentation of a tumour will probably exceed the life span of the patient.

1.6 NEED FOR RADIATION PROTECTION

Despite the significant roles of ionizing radiation in medicine, if adequate precautions are not taken during its application, an undesirable exposure of human beings to ionizing radiation could arise and this would have adverse effects on health. In order to ensure safety in all radiation practices, the International Commission on Radiation Protection (ICRP, 1990) has recommended three principles of operation that would ensure radiation protection of patients, radiation workers and the general public. These principles are itemized below:

(i). JUSTIFICATION

Justification means that before radiation exposure is carried out, the derived benefit from the procedure outweighs the associated detriment. Justification is applicable to the exposure of patient to ionizing radiation.

(ii). OPTIMIZATION: AS LOW AS REASONABLY ACHIEVABLE (ALARA)

ALARA means that the justified radiation exposure is kept as low as reasonably achievable. In medical x-rays examinations, ALARA means that the radiation burden to patient is kept as low as reasonably achievable and is consistent with obtaining the required diagnostic information. Optimization is also applicable to the exposure of patient to ionizing radiation.

(iii). DOSE LIMIT

Dose limitation is not applicable to the exposure of patient to ionizing radiation for medical purposes but it is applicable to both radiation workers and the general public. This principle is meant to ensure that the radiation dose received by workers during their normal working hours and the general public, who are not frequent in the radiation premises, does not exceed the recommended dose limit. The recommended dose limit for radiation workers and the general public is 20 mSv per annum (averaged over five years) and 1 mSv per annum respectively.

1.7 CANCER INCIDENCE IN NIGERIA

Cancer is a global health problem with increasing incidence in the developed and developing countries (Boyle, 2006; Boyle 2008; Fontham, 2009). Research showed that certain risk factors increase the chance that a person would develop cancer. The most common risk factors, which could dispose one to cancer, are growing older, tobacco, sunlight, certain chemicals, some viruses and bacterial, certain hormones, family history of cancer, alcohol, poor diet, overweight, ionizing radiation etc. (National Cancer Institute (NCI), 2006).

The most common way by which population gets exposed to ionizing radiation is through medical x-ray examination. In a group of 100 Nigerians, about 70 % would undergo x-ray examinations in their lifetime either for the purpose of employment, admission into higher institutions or for medical treatment. There are more than 5,000 x-ray centres distributed all over Nigeria, servicing a population of 150 million and each has the potential to perform x-ray examination for 100 patients per day. For instance, the patients' log book located at the Radiology Department, University College Hospital (UCH) Ibadan, showed that about 500 (obtained from patient log book) patients undergo x-ray examinations on daily basis.

Cancer registration in Nigeria officially began in the year 1960 but it was not until 1990 that a national headquarters of cancer registries was established in Ibadan (Sridhar et al., 2009). All cancer related diseases presented at all radiotherapy centres in Nigeria are documented and forwarded to this unit for record purposes. There are five functioning radiotherapy centres in Nigeria at the time (2004 - 2006) of this study. They are University College Hospital, Ibadan; Lagos University Teaching Hospital, Idi Araba Lagos; National Hospital, Abuja; Ahmadu Bello University Teaching Hospital, Zaria and EKO hospital (private) Lagos state.

In Nigeria, the burden of cancer is gradually becoming appreciable. For instance, at the cancer registry, University College Hospital, Ibadan, it was found that about 25,000 new cancer cases are diagnosed per year. However, the World Health Organization gave an estimate of 100,000 new cases per annum in the country and it was believed that the figure could become as high as 500,000 new cases by the year 2010 (Sola and Chioma, 2008). In the 2008 world cancer report, it was predicted that

global cancer rates could further increase from 12 million new cases (in 2005) to 15 million in the year 2020.

The gradual rising in the incidence of cancer in the country has made the Federal Government to set up a committee, known as Consultative Committee on National Cancer Control. This body is responsible for formulating guidelines that would help the country to prevent the occurrence of cancer and also improve the existing cancer management in the country. Also, there are professional bodies, such as the Nigerian Cancer Society, the Society of Oncology and Cancer Research in Nigeria and several other local and international organizations, actively involved in cancer control and prevention in the country.

The most common cancers seen among Nigerians are carcinoma of the uterine cervix and breast (for women) and liver and prostate cancers (for men) (Sridhar et al., 2009). Many of these cancers can be prevented if one stays away, as much as possible, from the known risk factors stated earlier.

1.8 CURRENT STATUS OF RADIOLOGICAL PRACTICES IN NIGERIA

In Nigeria, the request for medical x-ray diagnostic examination is no longer limited to the physically sick people but also required for admission into higher institution of learning and for employment into labour force.

As the need for diagnostic x-ray examinations increases, more diagnostic centres sprang up in different part of the country. This eventually increased the number of x-rays machines imported into the country. Despite increase in the number of radiation facilities in the country, it was not until some few years ago that an attempt was made to put in place regulatory code of conduct that would guide and monitor the activities of x-ray centres in Nigeria.

In the year 2001, the Nigerian Federal Government, under the Nuclear Safety and Radiation Protection Act of Parliament 19 of 1995, constituted a regulatory body, known as the Nigerian Nuclear Regulatory Authority (NNRA). This body was charged with the responsibility to ensure that all nuclear radiation activities in the country comply with the international standard code of practice. The standard code of practice

for radiation activities includes well shielded infrastructure, optimization of radiation exposure of patient, radiation protection of patients, personnel and the general public.

In Nigeria, the practice of radiology in the absence of regulatory authority paved way for unhealthy radiation practices among diagnostic centres. These unhealthy practices include procurement of outdated x-ray machines, absence of beam quality control measurement record and lack of record on dose to patient per x-ray examinations. All these had made it difficult to audit radiology practices in Nigeria.

There are about 5,000 diagnostic x-ray centres located in different parts of Nigeria and NNRA has not been able to inspect all of them for compliance with the standard code of radiological practices. The few centres, which had undergone NNRA initial inspection, had been mandated to submit the beam quality control measurement (i.e. acceptance testing and commissioning) of their x-ray machines. Their submission determines the issuance of license to provide radiology services and failure to comply within a particular period attracts closure of their diagnostic centres.

There are very few diagnostic centres in Nigeria that have the basic quality control equipment. This quality control equipment, even though available, is under utilized because the Medical Physicist, who is trained to use the equipment is not employed by these diagnostic centres. The belief of most diagnostic centres is that the ionizing radiation from x-ray machines does not require elaborate radiation protection like those emitted from high energy radiotherapy machines. However, in order to correct this misconception, NNRA mandated the licensee to appoint a Medical Physicist, who would either be on a full time appointment or a part time Radiation Safety Adviser to the centre.

As stated earlier, majority of x-ray centres in Nigeria had no record of dose distribution to various organs of patients under their management and the effective dose incurred by patients during x-ray examinations is not well documented. This made it difficult to compare doses to patient from x-ray examinations between different centres. Similarly, the risk associated with the examinations has been very difficult to estimate because the required data are not available at the x-ray diagnostic centres.

Also, most diagnostic centres procured refurbished and outdated x-ray machines which tend to perform below the standard of good radiological practices. In addition to these, some x-ray machines were put into clinical services beyond their useful life time. For instance, the age of x-ray machine, used for this study at the University College Hospital (UCH) Ibadan and Obafemi Awolowo University Teaching Hospital (OAUTH) Ile-Ife, which happen to be among the leading health care centres in Nigeria, was 30 years and 23 years respectively. Plans have been put in place by the Management of these centres to replace the outdated x-ray machines with new ones in the nearest future.

So far, the establishment of the NNRA is gradually restoring sanity into radiological practices in Nigeria. This was made possible through the disciplinary measures put in place by the NNRA. These include closure of any x-ray centre, whose infrastructure does not conform to the standard of practice, ban on the importation of x-ray machine older than 5 years from the time of manufacture. Also, as safety measures, all radiation workers must wear monitoring badges during working hours, the compulsory annual quality control measurement of x-ray machines must be documented, machine specific information such as model, year of manufacture, serial number, etc. must be documented, a Medical Physicist or Radiation Safety Adviser (RSA) must be appointed. Regular monitoring and inspection of x-ray facility by NNRA inspection team must be carried out without prior notice.

1.9 JUSTIFICATION OF THIS STUDY

From the current status of radiological practices in Nigeria stated in section 1.8, there are glaring deficiencies in the practices. Some of these deficiencies are inadequate infrastructure, non availability of radiation beam quality control equipment, insufficient radiation monitoring devices, inadequate personnel monitoring and lack of record on dose to patients. Most radiology centres in Nigeria placed emphasis on justification of radiation practice with little concern for optimization of the protection of patients during the procedure.

1.9.1 AIMS AND OBJECTIVES

The aims of this study are:

1. To calculate the effective dose received by patients during diagnostic x-ray examinations from four diagnostic x-ray centres in Nigeria; and
2. To estimate the risk associated with different type of x-ray examinations at the selected centres.

These would be achieved through the followings tasks:

- i. Measurements of radiation beam output and quality control of exposure parameters (kVp, mAs) at each centre.
- ii. Collection of demographic data (age, sex, weight and height) for patients and x-ray examination data (site of examination, field size, selected exposure parameters, FSD) which are required for PCXMC computation of doses to organs and effective doses.
- iii. Estimation of cancer risk from calculated effective dose per examination and make a comparison of the results with the International Commission on Radiation Protection (ICRP) recommendations.
- iv. Evaluation of the design of x-ray room for the protection of patients, personnel and the general public at each centre.

CHAPTER TWO

LITERATURE REVIEW

2.1 *MEDICAL DIAGNOSTIC X-RAY TECHNIQUES*

Prior to the discovery of x-rays, invasive procedure was the only technique known for diagnosis of diseases in medicine. This invasive procedure involves surgical operation of the affected part of the body to determine the ailment. This procedure is quite traumatic with a lot of risk associated.

The discovery of x-rays in the year 1895 provided the much desired non-invasive technique of unmasking internal structures of human anatomy (Ogunseyinde, 2009). Since then, applications of x-rays in diagnostic radiology (medicine) had developed into medical specialty with varieties of imaging techniques. The x-ray machine that could be used for different imaging techniques ranged from simple to sophisticated x-ray machines. The choice of x-ray machine for a particular imaging is a function of the organ under investigation. Some of the x-ray machines suitable for clinical diagnostic investigations are discussed below:

2.1.1 *FLUOROSCOPY (INTERVENTIONAL RADIOLOGY)*

This is an x-ray machine that is used to produce live image of internal structures. During a fluoroscopic examination, a continuous x-ray beam is used to view an organ in real time. The live image of the organ under investigation is displayed on a television monitor. Fluoroscopes are used for interventional procedures such as guiding the placement of a catheter during arteriography (examination of arteries), assessing stomach and bowel movement and functions and detecting obstructions in the airway or blood vessels.

The receptor for the first-generation fluoroscope was a flat fluorescent screen, which intercepted the x-ray beam as it emerged from the patient's body. The x-ray beam carrying the invisible image was absorbed by the fluorescent material and converted into a light image. It is the fluorescent screen receptor that gives the name "fluoroscopy" to the procedure. The fluorescent screen was usually very dim and the

image had a relatively low brightness level. For this reason, the radiologist was forced to dark adapt his eyes before examining the patient. Although this system was simple and intuitive but the contrast sensitivity and visibility of detail were significantly poor and a relatively high dose of x-rays (increased tube current) was needed to produce a brighter image on the fluorescent screen.

For this reason, modern fluoroscopy machines have replaced the simple fluorescence screen with an image intensifier tube coupled to a video camera. The image intensifier tube employs the mechanism of electron multiplication to greatly increase the flux striking the fluorescent screen, thereby reducing the amount of x-ray exposure required to produce an image. The intensifier tube produces a much brighter image than the fluorescent screen and its image can be viewed in a lighted room. For this reason, the radiologist does not need to dark adapt his eyes before carrying out fluoroscopy. The quality of the image produced was generally an improvement over the fluoroscopic screen image. The video (TV) system is to transfer the image from the output of the image intensifier tube to a large screen.

An example of a modern fluoroscopy machine with its associated parts (labeled with number) is shown in figure 2.1. A fluoroscopy machine (10) includes x-ray source (12) attached at one end of a C-arm (14) to project x-rays along an axis (16) bisecting the circle of the C-arm. The other end of the C-arm supports an image intensifier/camera unit (18) positioned to receive x-rays along the axis while providing a gap between the x-ray source and the image intensifier/camera unit to receive a patient (17). The C-arm is supported by a collar (20) to slide therein. A three-dimensional tracking antenna (28) is attached to the x-ray source so as to provide identical information about the position of x-ray axis. The image is processed by the image processor based on input from the three-dimensional tracking receiver (30). Additional antennas (32) and (36) are used to allow the three-dimensional tracking receiver to monitor the relative position of other objects. In order to match the image with the actual object (patient), head-mounted display (40) optics is used. A conventional display (42) is also connected to image processor to receive an image signal as processed image.

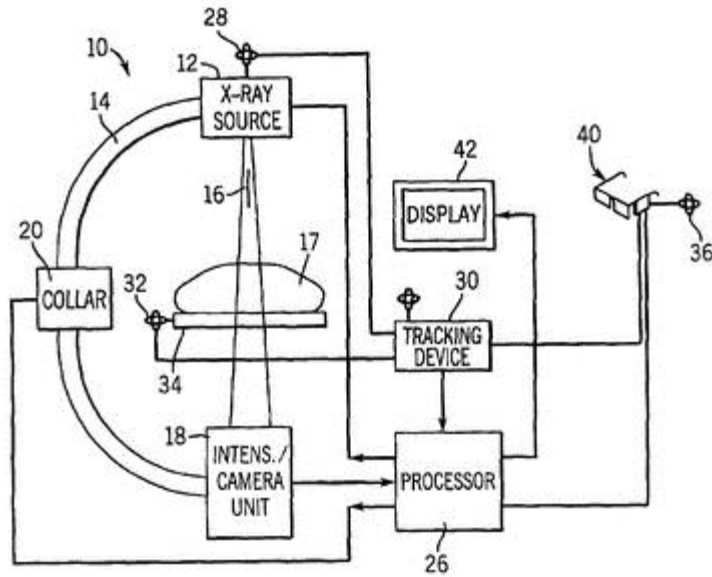

The number code in the above diagram is interpreted as follows:

- 10 – Fluoroscopy machine*
- 12 – X-ray source*
- 14 – C-arm*
- 16 – Axis of the C-arm*
- 17 - Patient*
- 18 – Intensifier/Camera unit*
- 20 – Collar*
- 28 – Tracking antenna*
- 30 – Tracking receiver*
- 32, 36- Additional Antennas*
- 40 – Head-mounted display*
- 42 – Conventional display.*

Fig. 2.1 Fluoroscopy machine with head mounted
(retrieved from <http://www.freepatentsonline.com>)

Fluoroscopy x-ray machine is most often used to view the upper gastrointestinal (GI) tract, which includes the stomach, oesophagus, duodenum and upper small intestine. Also, it is used to view the lower GI tract. Fluoroscopy involves higher radiation doses to patients than film radiography and also poses a radiation hazard to the Operator (Ionising radiation regulations, 1988).

2.1.2 COMPUTED TOMOGRAPHY (CT)

Computed Tomography is a medical imaging procedure that uses the concept of tomography to deliver x-ray images in 2-dimensional cross sectional formats. CT differs from conventional projection x-ray imaging in several respects. For instance, the formation of the CT image is a multi-step process whereas in conventional imaging modality, the image formation is a single step process.

Image production in CT begins with the scanning phase, where a thin-fan shaped x-ray beam is projected through the edges of the body section (slice) being imaged. The radiation that penetrates the section is measured by an array of detectors. The detectors do not see a complete image of the body section but only a profile from one direction. The profile data are measurements of the x-ray penetration along each ray extending from the x-ray tube to the individual detectors. In order to produce enough information to create a full image, the x-ray beam is rotated (scanned) around the body section to produce views from many angles. Typically, several hundred views are taken, and the profile data for each view are stored in the computer memory.

The total number of penetration measurements made during a scan is the product of the number of views and the number of rays within each view. The total scanning time for one slice could range from approximately 1 to 15 seconds, depending on the design of the scanner mechanism and the selection of scanning variables by the operator. In general, the quality of the image can be improved by using longer scanning times.

The second phase of image production is image reconstruction. This is performed by digital computer, which is part of the CT system. Image reconstruction is a mathematical procedure that converts the scan data for the individual views into a

numerical, or digital, image. The image is structured in an array of individual picture elements (pixels). Each pixel is represented by a numerical value (CT number). The specific value for each pixel is related to the density of tissue in the corresponding volume element (voxel). Reconstruction usually takes several seconds, depending on the complexity of the image and the capabilities of the computer. The digital image is stored in the computer memory.

The final phase is the conversion of the digital image into a video display so that it can be viewed directly or recorded on film. This phase is performed by electronic components that function as a digital-to-analog (video) converter. The relationship between the pixel CT number values and the shades of gray (brightness) in the displayed image is determined by the window levels selected by the operator. Through the manipulation of the window levels, the brightness and contrast of the displayed image could be adjusted. The window setting determines the range of CT numbers that are spread over the entire image gray scale.

The x-ray beam in a CT system must have an appropriate shape, intensity distribution, and ability to rotate around the body of patient. An example of CT machine is shown in figure 2.2. The x-ray tube is mounted on a circular gantry assembly, which rotates the x-ray beam around the patient's body. Supplying electrical power to the tube while it is rotating is awkward. For this reason, most scanners use cables that wrap around the gantry while it is rotating. This design allows a few rotations in which the gantry must be stopped and rotated in the other direction to uncoil the cables. Another design uses sliding electrical contacts or slip rings that permit continuous high-speed rotation.

The x-ray tube assembly contains collimating devices that determines the physical size and shape of the x-ray beam. One set of collimators determines the angular span of the beam and another set determines its thickness. The latter set could be adjusted to vary slice thickness. Also, the x-ray tube assembly contains metal filters through which the x-ray beam passes. CT x-ray beams are filtered for two purposes namely beam hardening and compensation. Beam hardening refers to the process of increasing the average photon energy. This occurs when the lower energy photons are absorbed as the beam passes through filtering material.

DATA ACQUISITION SYSTEM
continuous acquisition of CT data
up to 140 levels in 15 seconds

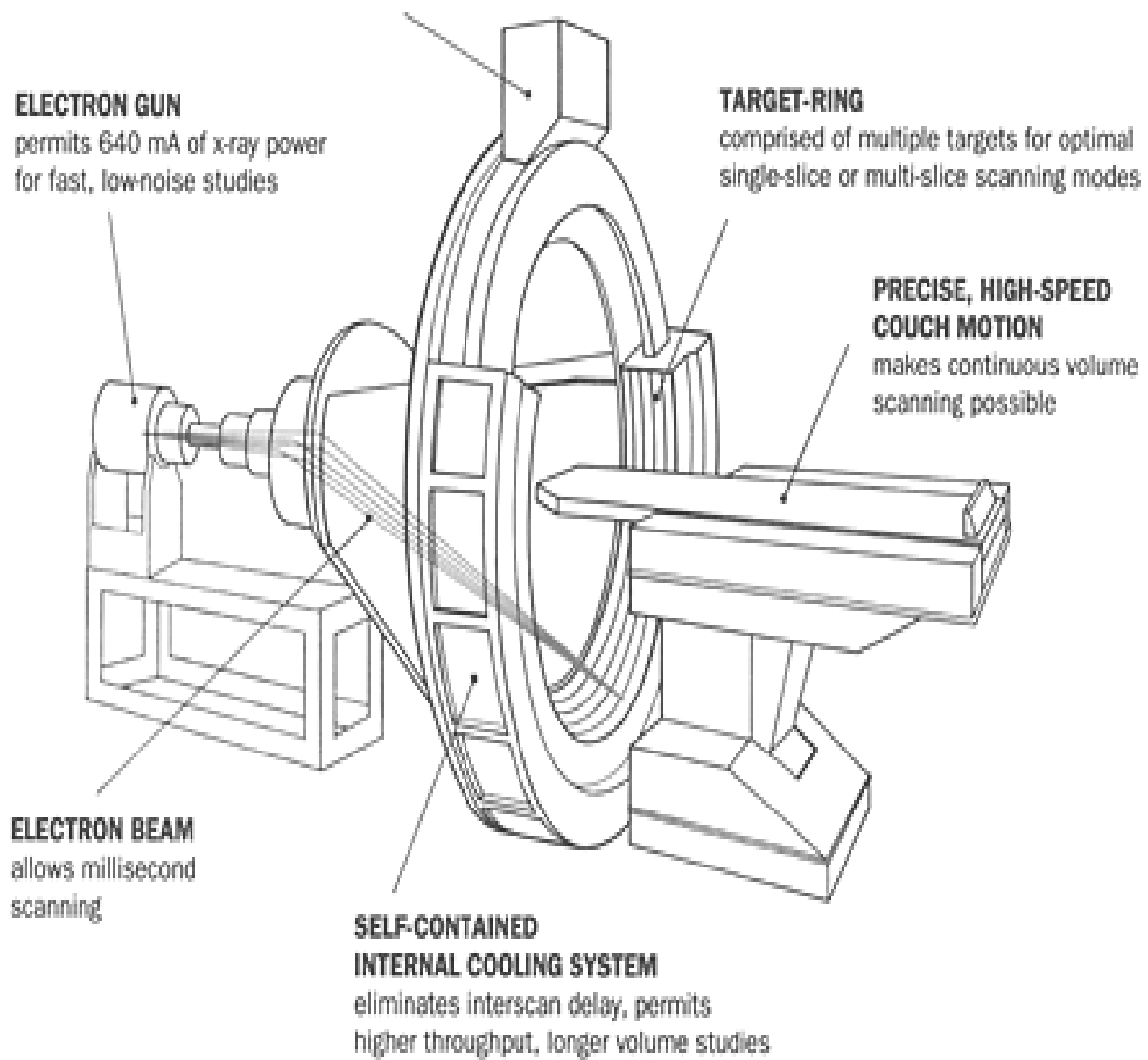

Fig. 2.2

Computed Tomography (CT) Machine

(Retrieved from www.themesotheliomalibrary.com/ct-scanner)

Compensation is the process whereby a filter with a non-uniform thickness is placed in the x-ray beam to compensate for the non-uniform thickness of the human body. When compensator is used, the thick centre section of the body is exposed to higher radiation intensity than the thinner sections near the edges. The use of compensator generally reduces patient exposure while maintaining a specified level of image quality.

The generator or power supply for a CT system is typically a constant potential type that can produce relatively high kV and mA values for a sustained period of time. In a CT system, the radiation receptor is an array of many small detectors. Several types of detectors are in use today. The way in which they are mounted within the gantry assembly could vary from one scanner type to another. The function of a detector element is to absorb the radiation it intercepts and then produce an electrical signal in proportion to radiation intensity. In principle, each detector measures the radiation that penetrates the body section in the direction of the detector.

Several materials are used for CT detectors. Solid-state detectors are made of solid scintillation crystals that convert the x-ray energy into light. The light is then converted into an electrical signal by either a photodiode or photomultiplier (PM) tube. In another design, each detector is a small chamber filled with a high pressure gas, typically xenon. The radiation absorbed within the chamber ionizes the gas and change its electrical conductivity. Two of the most important characteristics of a detector are size and efficiency for absorbing radiation. Small sizes of detectors are needed to achieve high detail (contrast) in CT images while high detector efficiency is desirable to reduce patient dose for a specific level of image quality.

2.1.3 MAMMOGRAPHY

Mammography is a specific type of imaging that uses low dose x-ray system to examine human breasts. Mammography is a highly effective clinical method for detecting, diagnosing and managing a variety of breast diseases, especially cancer. In this way, mammographic procedure has helped to minimize the rate of mortality from breast cancer.

In mammography applications, emphasis on dose to patient and risk reduction is highly required. This is due to two main factors. First, the breast tissue has a relatively high sensitivity to some adverse effects of radiation, and secondly, mammography requires higher exposure (mAs) to produce the desired image quality compare to other radiographic procedures. The reason why higher exposure is employed in mammography is because the breast is composed of soft tissues (adipose tissue and fat) which have very low contrast characteristic. Therefore, more radiation would be required to produce visible image of both normal breast anatomy and signs of disease.

In mammography, a very low kV is needed to achieve sufficient contrast between the fairly thin soft tissue and the fatty structures of the breast. However, at the very low values of kV (20 – 40 kV) that are being used, the radiation beam penetration is very poor. In order to obtain sufficient blackness on the film, a very high exposure (10 – 20) R and invariably high patient dose has to be given. This is quite unacceptable, especially if the procedure is meant for screening of symptomless, healthy group of women in an attempt to detect early breast cancer (Massey, 1968). The radiation exposure of such magnitude (≥ 10 R) on yearly screening process repeatedly, could cause more cancers than are detected.

In order to prevent excessive radiation dose to patient, an x-ray tube having molybdenum target as compared to the more usual tungsten or tungsten-rhenium target has been employed in mammography machine (Perry, 2011). With the molybdenum target, a large fraction of K-characteristic radiation of energy in the range of (17 – 20) keV could be produced at values of kV around 20 to 30 kVp. In the x-ray spectral analysis of the emitted x-rays, a substantial amount of low energy, low penetrating bremsstrahlung radiation is also emitted in addition to the k-characteristics radiation.

When the beam is filtered by a thin molybdenum filter, the k-radiation would be preferentially transmitted. Hence, the major part of the radiation spectrum incident on the patient would be in the spectra range needed to achieve the image contrast. With this set-up, the radiation dose to patient has been greatly minimized.

The radiation dose to the breast of an individual patient is determined by a combination of three factors namely (i) the characteristics of the equipment being used, (ii) the technique factors selected for the examination and (iii) the size and density of the breast of the patient. Most mammography technique uses the tube voltage of about 28 kV and tube current-exposure time of 32 mAs for normal breast examination.

A typical mammography x-ray machine is shown in figure 2.3. The diagram shows a fixed vertical stand that supports the whole x-ray unit. Attached to this stand are the x-ray tube, compression plate and a cassette plate. In addition to these is a control unit (although not shown in the figure) where the x-ray machine is operated. It is either located outside the mammography room or inside the same room at a good distance of about 150 cm away from the x-ray tube. For the purpose of radiation protection, a lead glass is usually mounted between the x-ray unit and the control panel. The operator stands behind this lead glass during radiation exposure for protection against scattered radiation from the patients and the x-ray assembly.

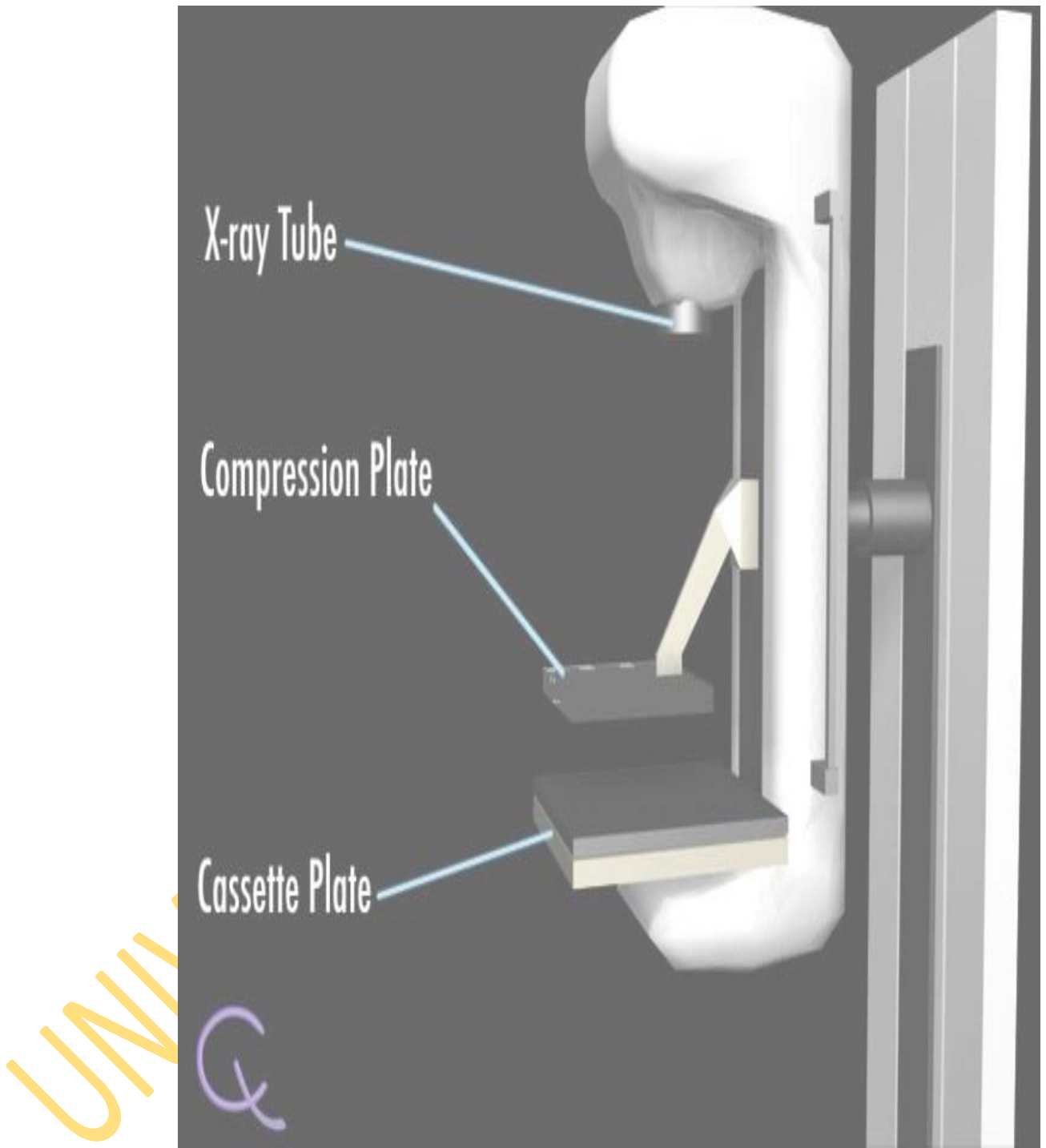

Fig. 2.3 Mammography x-ray machine (Retrieved from cancerquest.org)

2.1.4 FILM/CONVENTIONAL RADIOGRAPHY (CR)

This is an imaging technique that uses x-rays to image the human structure. In film radiography, as the beam of x-rays is transmitted through the patient, the different tissues within the patient attenuate the beam to produce a shadow picture of the internal structures. A diagnosis of ailment is thereafter made from the processed picture (image). Since the eye is insensitive to x-rays, this image is converted to a visible image by a fluorescent screen and film. Film radiography is also referred to as Conventional Radiology (CR). The attenuation of x-ray beam by human tissues of different composition results in varying transmitted radiation. The pattern of transmitted radiation could be expressed in terms of variations in photon fluence, energy fluence and exposure.

The x-ray beam that emerges from the patient contains both the primary and scattered radiation. These travel towards the image receptor or film. For beam energies (≤ 150 keV) used in medical diagnosis, and for thickness of tissue encountered in patient examination, the scatter component of emergent beam is considerably greater than the primary component. Since only the primary beam contains useful information about the object being examined, it is necessary to reduce the scattered radiation reaching the film. One of the ways by which this is achieved is by applying a grid between the patient and the film. The grid allows only radiation which comes from the direction of the source to reach the film. The mechanism by which grids is used will be discussed further in section 2.3. The scattered component of the emergent beam could also be reduced by limiting the size of the x-ray field to the region of examination.

As the beam of x-rays emerges from the body of the patient, it contains an image in the form of variations in exposure across the image area. A significant characteristic of this invisible image is the amount of contrast it contains. Contrast means difference. Contrast is represented by the amount of variation in x-ray exposure between points within the image. The amount of contrast produced in a specific examination is determined by both the physical characteristics of the body section and the penetrating characteristics of the x-ray beam. For an object to be visible in an x-ray image, it must have physical contrast in relationship to the tissue or other material in which it is embedded. This contrast can be a difference in physical density or chemical

composition (atomic number). The beam that finally reaches the film contains both useful information and noise. The noise refers to variations in the intensities of the beam in the image plane that are not due to corresponding variations in transmission of the beam by the patient. Different tissues (fat, soft tissue and bone) can be distinguished from one another after image processing because they attenuate x-rays in different ways.

When the film is exposed to ionizing radiation, a chemical change takes place within the exposed crystals to form latent image. The amount of exposure required to produce an image depends on the sensitivity (speed) of the film being used. Some films are more sensitive than other because of their design or the way they are processed. The sensitivity of radiographic film is generally selected to provide a compromise between two very important factors namely patient exposure and image quality. A highly sensitive film reduces patient exposure but decreases image quality. After processing, the image on the film is permanent and cannot be changed. The processed image is viewed by trans-illumination from a view-box.

Film has been the traditional medium for medical image storage. If a film is properly processed, it will have a lifetime of many years and will, in most cases, outlast its clinical usefulness. Because film performs so many of the function that makes up the radiographic examination, it will continue to be an important element in the medical imaging process.

A typical film radiography x-ray machine is shown in figure 2. 4. It has a control console, a ceiling suspended x-ray tube, a collimator, a couch with a cassette/ grid slots and removable cassette plate. This is similar to all the x-ray machines selected for this study. Film radiography is applicable for imaging any part of the human body, especially the bony structures.

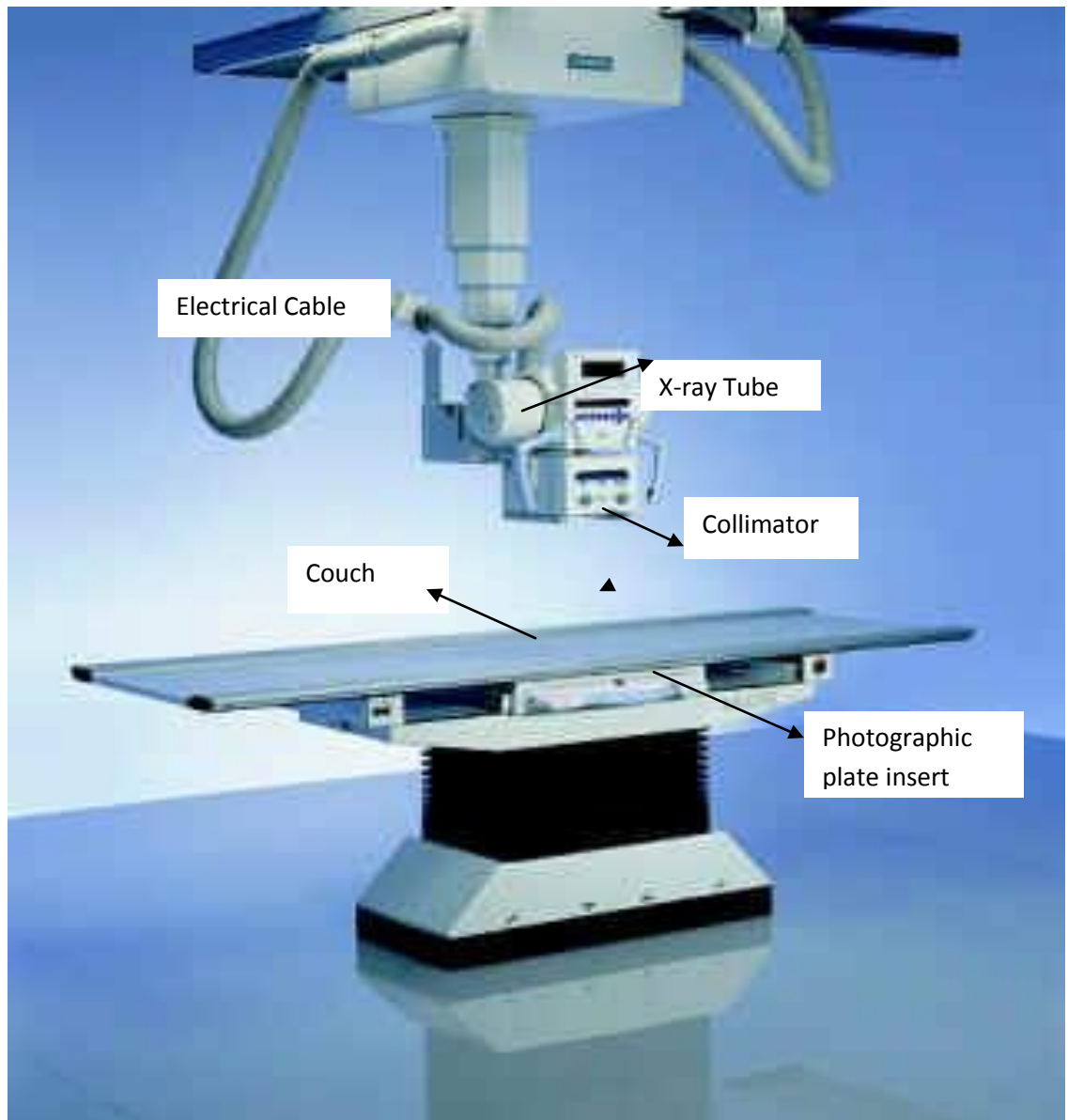

Fig. 2.4: Conventional/Film Radiography x-ray machine (Retrieved from http://www.spectrumxray.com/medical_xray_equipment.html)

2.2 CHARACTERISTICS OF IMAGES PRODUCED IN DIAGNOSTIC X-RAY TECHNIQUES

An x-ray image is a visual representation of a specific physical object, such as the body of patient. An important characteristic of any medical imaging technique is its ability to show the anatomical detail of the human body (Perry, 1987). The term detail in image formation refers to small structures, features and objects associated with normal anatomy and various pathological conditions.

The image of the human body displayed by any of the diagnostic techniques discussed in section 2.1 is governed by two main factors namely image quality and visibility of structures. The visibility of structures is determined by the characteristics of the imaging system and the manner in which the x-ray machine is operated. The quality of a medical image is determined by the imaging method, the characteristics of the equipment, and the imaging variables (kV, mAs) selected by the operator. Image quality is not a single factor but is a composite of at least five factors which include contrast, blur, noise, artifacts, and distortion as shown in figure 2.5.

This diagram comprises of subject of the examination (the patient), the imaging system (the x-ray machine, the processor) and the image display devices. The image displaying devices could be television monitor or photographic film, depending on the diagnostic techniques involved. The operator selects the exposure parameters for the x-ray examination as illustrated in figure 2.5. Also, shown in this figure is an observer (Radiologist or Radiographer), who analyses the quality of the image and gives a report of the clinical findings. This clinical report is required for further medical management of the patient.

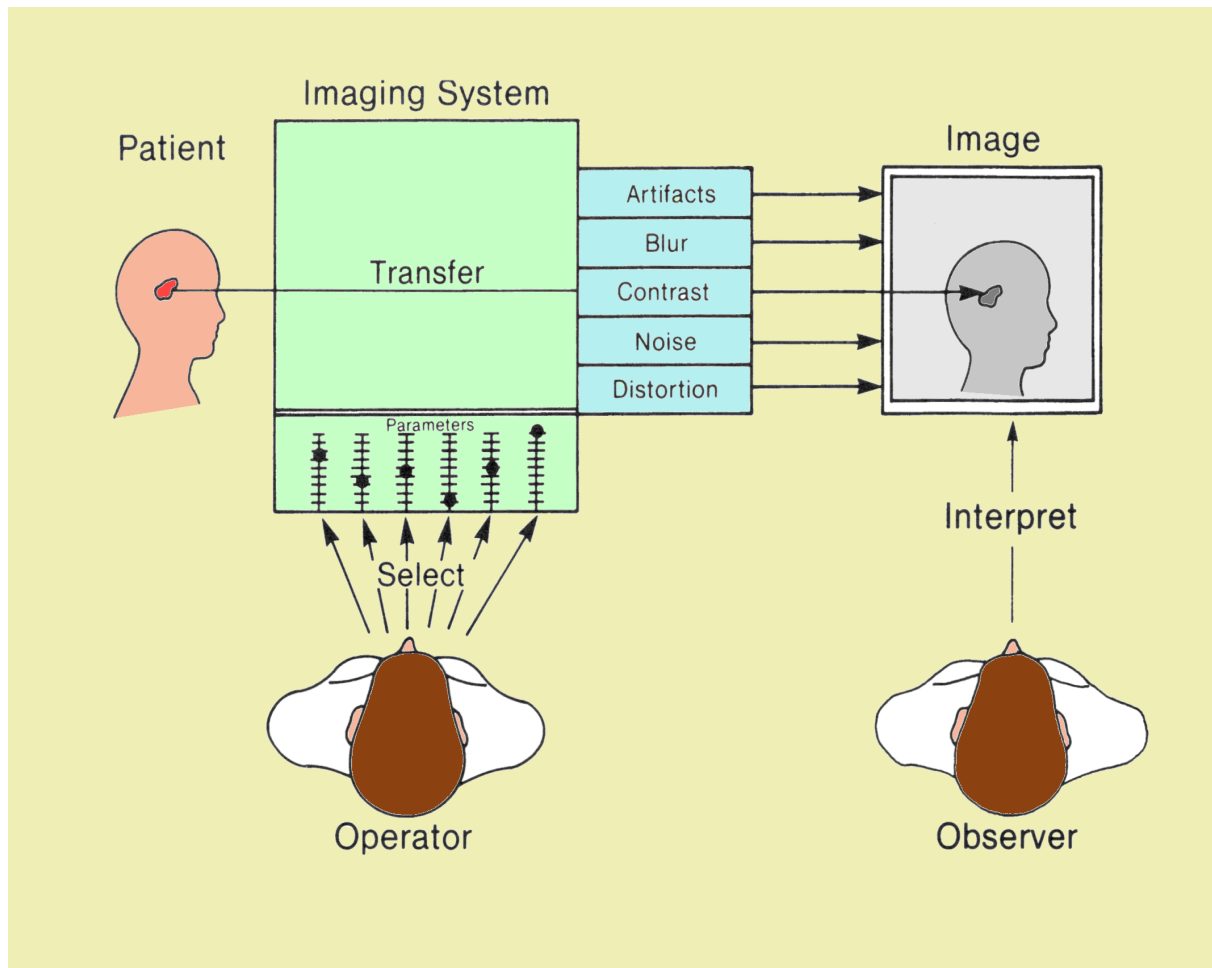

Fig 2.5 **Components Associated with the Medical Imaging Process (Perry, 1987)**

As shown in figure 2.5, the task of every imaging system is to translate a specific tissue characteristic into image shades of gray. If contrast is adequate, the object will be visible. The degree of contrast in the image depends on characteristics of both the object and the imaging system. Some of the essential components of image quality in film radiography are itemized below:

2.2.1 CONTRAST

Contrast is the most significant characteristic of an image recorded on film. Contrast means difference. An object within the body will be visible in an image only if it has sufficient physical contrast relative to surrounding tissue. In radiography practice, the contrast between a specific structure and its surrounding tissues is of clinical importance because it is the variation in film density (contrast) that actually forms the image (Perry, 1987). That means, without the contrast there is no image. The amount of contrast in an image depends on many factors which include the ability of the particular film to record contrast. The image contrast could be in the form of different shades of gray, light intensities or colours. The schematic diagram of image contrast of a foreign body is shown in figure 2.6 to illustrate shades of gray. The essence of gray shades is to differentiate organ under investigation from the surrounding tissues.

Films could be considered as contrast converter because of its ability to convert differences in exposure (subject contrast) into film contrast (differences in density). The ability of the film to convert exposure contrast into film contrast is expressed in terms of the contrast factor. The amount of contrast produced by medical imaging films depends on four basic factors which include type of emulsion, amount of exposure, processing and fog. The ability of a film to produce contrast could be determined by observing the difference in density between two areas receiving a specified difference in exposure. This is usually performed by a device known as sensitometer. In this method, a strip of film is divided into a number of individual areas, and each area is exposed to a different level of radiation.

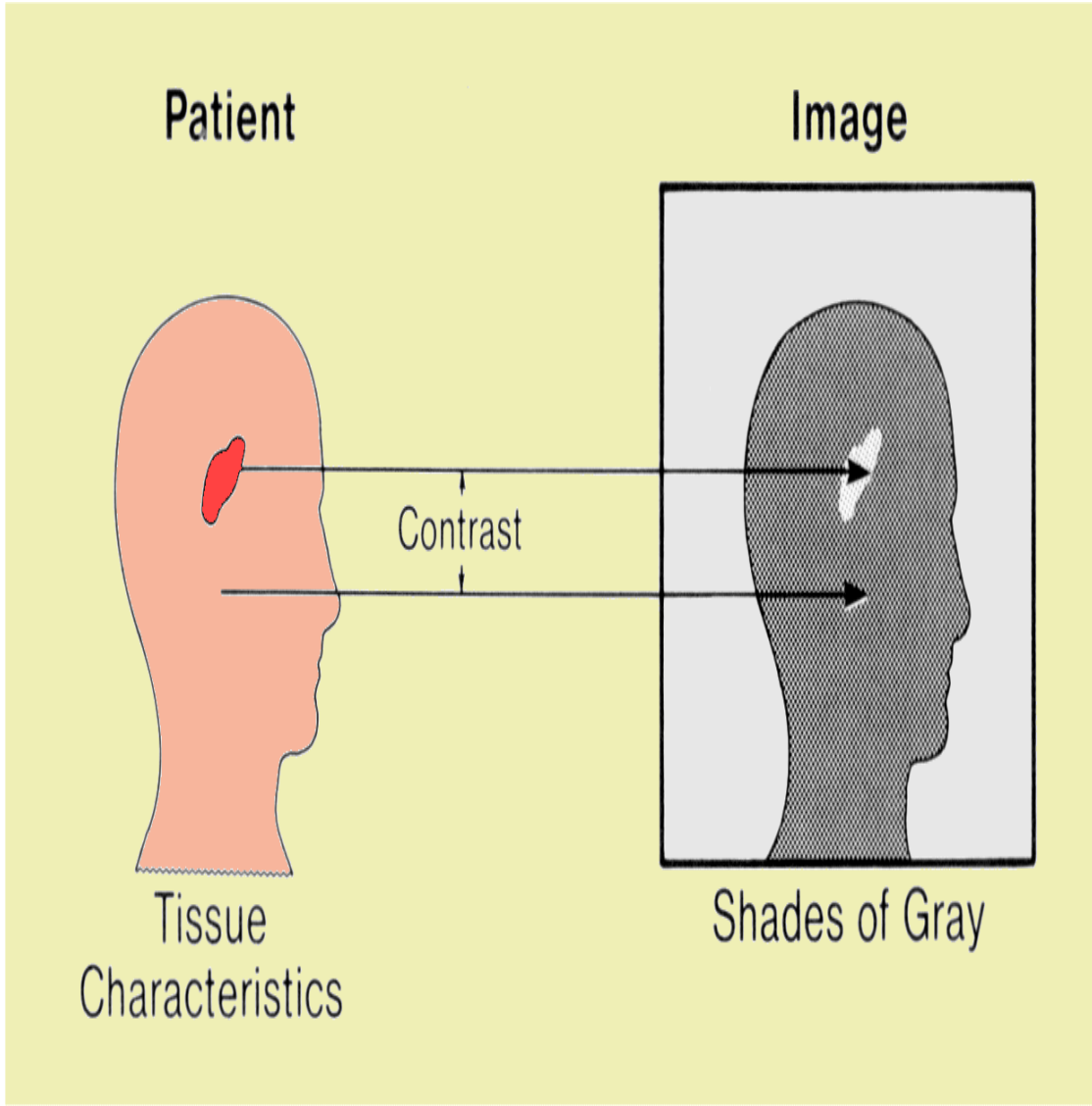

Fig 2.6: Schematic diagram of Image Contrast process (Perry, 1987)

When the film is processed, each area will have density values corresponding to the radiation exposure. The relationship between film density and exposure is often presented in the form of a graph known as film characteristic curve. The shape of the curve depends on the characteristics of the emulsion and the processing condition. The primary use of this curve is to describe the contrast characteristic of the film throughout a wide exposure range. The slope of this curve represents the contrast (density difference) produced by a specific exposure difference.

2.2.2 BLUR AND VISIBILITY OF DETAIL

Structures and objects in the body vary not only in physical contrast but also in size. Object ranges from large organs and bones to small structural features such as small calcifications. It is the small anatomical features that add detail to a medical image. Blurring is the spread of an object within an image. The smallest detail of an object that could be visualized is determined by the amount of blur produced by the imaging procedure. Some imaging procedures produce images with significantly less blur than others and this results in images that show much greater detail. Visibility of detail is limited because all imaging methods introduce one form of blurring into the process.

In an ideal situation, each small point within the object examined is supposed to be represented by a small, well-defined point within the image. But in reality, the image of each object point is spread or blurred within the image. The blur of a small object could have a variety of shapes depending on the source of the blur. Some x-ray system components, such as intensifying screens and image intensifier tubes, generally produce round blur patterns. Motions, such as, respiratory during the imaging process typically produces an elongated blur pattern. In every imaging process, the most significant effect of blur is that it places a definite limit on the amount of detail that could be visualized.

2.2.3 **SHARPNESS**

The term, sharpness, refers to the ability to recognize anatomical details of structures in an image. An image is sharp if its structures appeared on the display unit (photographic film, TV monitor) separately and distinctly. Sharpness could also be defined as the ease with which the edges and boundaries of structures within an image could be visualized. While the image contrast, discussed above, deals with the differences in blackening (optical density), sharpness reveals pattern of changes in optical density at the boundary between two adjacent parts. A sharp image is an x-ray image which shows details about the object under investigation with distinct boundaries.

2.2.4 **NOISE**

Noise is an undesirable signal or pattern that usually accompanies an image. Radiographic images normally consist of two components namely a meaningful signal, that carries information related to the image, and a spurious signal (noise), that carries no information. These two components are superimposed in the displayed image. The presence of too much unwanted signal or noise in an image limits the amount of useful or clinical information that could be extracted from the image. Examples of radiographic noise are fogging and black specks or quantum mottle usually observed on processed or developed film. Most of the noise, usually observed on the film after development, is due to faulty rollers in the processor, dirt in the film cassette and exposure of the film to external leakage light in the darkroom during film loading into the cassette.

2.2.5 **Resolution**

This is the ability of an imaging system to distinguish (resolve) objects that are close together. The resolving capability of a particular imaging process is determined by the amount of blur in the image. When blur is present, the images of individual objects would move together until separate objects are no longer distinguishable. For objects to be resolved, their separation distance must be increased in proportion to the amount of blur present. An imaging system which is able to reproduce closely spaced

structures in the patient as separate entities in the image is said to possess high resolution capability, while a system which cannot reproduce such details is said to possess low resolution capability. The resolution of an imaging system is easy to measure and this measurement is often used to evaluate x-ray system blur. The common practice for measuring resolution is to use a test object, which consists of parallel lead strips separated by a distance equal to the width of the strips. This line width and separation distance is usually described in terms of line pairs (lp) per unit distance (mm or cm).

2.2.6 ARTIFACTS

From the discussions so far, it could be seen that several characteristics of an imaging method could cause certain structures in the body to be invisible on the film. Another problem is that most imaging methods can create image features that do not represent a body structure under examination. These abnormalities are known as image artifacts. In many situations an artifacts does not significantly affect object visibility and diagnostic accuracy, rather it obscures a part of an image or misinterpreted as an anatomical feature. A variety of factors associated with each imaging method can cause image artifacts.

2.2.7 DISTORTION

A medical image should not only make internal body objects visible, but should give an accurate impression of their size, shape, and relative positions. An imaging procedure could introduce distortion or variation in size, shape and relative position of the object under investigation.

2.3 FACTORS AFFECTING RADIATION DOSE TO PATIENT IN DIAGNOSTIC X-RAY IMAGING TECHNIQUES

The magnitude of radiation dose received by patient during radiological investigation is very important for evaluation of optimization of radiation protection. Optimization means that the dose received by patients during diagnostic examination is compatible with the intended medical purpose. The exact radiation dose received by internal organs of patients during medical x-ray examination could be very difficult to obtain. However, dose estimation could be obtained from measurements of radiation incident on the skin of patients. The most common quantity used for the estimation of dose to patient in diagnostic x-ray examinations is the entrance skin dose, ESD, and it is expressed as (Massey, 1977):

$$ESD(mGy) = \frac{0.17(kV)^2(mAs)}{(X_{cm})^2} \quad (2.1)$$

Where, kV is the tube voltage, mAs is the tube loading and X is the focus to skin distance. From equation (2.1), it could be seen that the magnitude of ESD is directly proportional to the tube current (mA), the duration of exposure (sec), the square of tube voltage (kV) and is inversely proportional to the square of the distance from the radiation source.

In most clinical x-ray examinations, more than 90 % of radiation beam energy is absorbed by the human body. The radiation dose imparted to a particular organ is a function of the beam energy fluence (concentration), the size and density of the exposed area. In addition, the distribution of radiation to various organs and tissues of patient varies substantially with the position of the patient with respect to the x-ray source/tube. When patient faces the x-ray source, the x-ray projection is called antero-posterior (AP), when patient backs the x-ray source, the x-ray projection is called postero-anterior (PA) and when any side (left or right) of the patient faces the x-ray source, the projection is called (left or right) lateral (LAT). The choice of x-ray projection depends on the clinical investigation.

There are several factors that could affect ESD to patient in diagnostic x-ray examinations. Some of these factors are beam energy, beam filtration, collimation,

size of the patient, thickness (density) of the area under examination, slice thickness, table rotation, screen-film combinations/speed, film processing conditions, compression, magnification, grids, and others. Since the focus of this study is on film radiography, the factors which are related to film radiography would be discussed. The emphasis of the discussion would be on how they affect image quality and dose to patient. Some of these factors are discussed in the following sections:

2.3.1 BEAM EFFECTIVE ENERGY

Energy is the ability to do work. X-ray beam energy is the inherent ability (quality) of an x-ray beam to penetrate tissues and organs of patients. The beam quality has a major impact on dose to patient and smaller impact on the quality of the final image. The x-ray beam energies used for diagnostic x-ray examination contains a spectrum of photon energies and for that reason, the penetration of x-ray beam into tissues varies with energy (kV). The overall penetration of x-ray beam into tissues corresponds to the penetration of photon energy between the minimum and maximum energies of the spectrum. This energy is referred to as the effective energy of the spectrum and is shown in figure 2.7.

The effective energy of an x-ray spectrum is the energy of a mono-energetic beam of photons that has the same penetrating ability as the spectrum of photons. Since the attenuation curve for a given material is characterized by the linear attenuation coefficient (μ), the effective energy is determined by the energy of mono-energetic photons which have the same μ as the given x-ray beam. In general, the μ or the effective energy of a heterogeneous beam varies with the absorber thickness. During interaction of radiation with matter, such as human body, there is usually transference of energy between them. The beam energy transferred to the human body is a function of beam quality (μ) and the size (thickness) of the exposed area.

X-ray beam quality is a function of the applied tube voltage (kVp) and the degree to which the beam are filtered. If all other imaging parameters are constant, the radiation dose (ESD) to patients would vary directly as the square of the applied kVp. As the kVp increases, the effective energy of the beam and its penetration through the patient also increases.

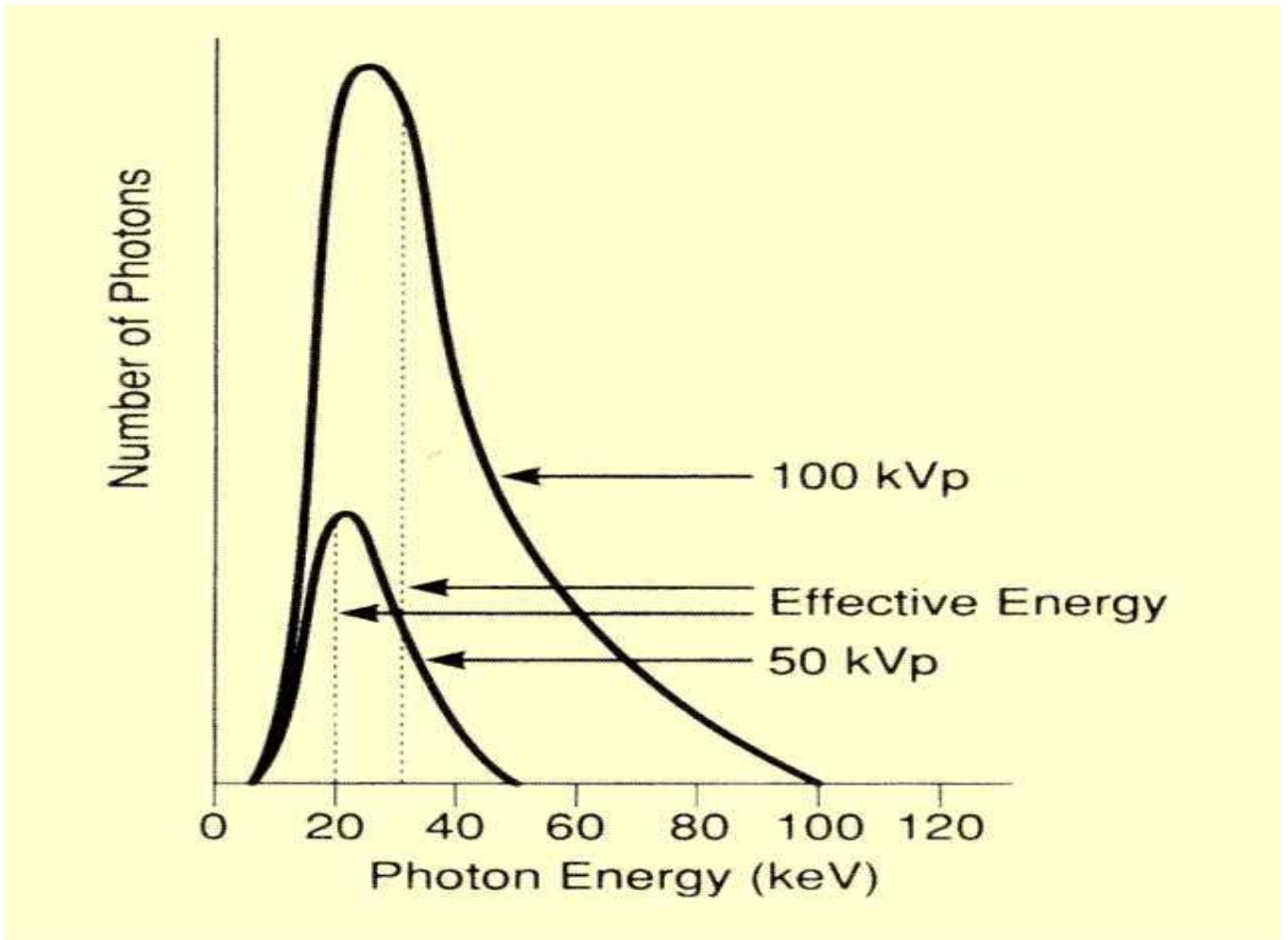

Fig. 2.7: Effective Energy of X-Ray Spectra
(Retrieved from <http://www.sprawls.org/ppmi2/radpen>)

The more penetrating an x-ray beam becomes, the faster would be its forward transmission to the image receptor (film cassette) and consequently improves the image quality. Beam quality would change as the x-ray tube ages due to deposition of target material on the inside of the tube window and to roughening of the target track (CEC, 1996). In radiographic techniques, there are three parameters that must be selected on the control console of an x-ray machine before radiation exposure needed for diagnostic examination could be effected. These exposure parameters are tube voltage (kVp), tube current (mA) and exposure time (s). In clinical practice, selection of higher kVp is usually complemented with lower mAs for optimal radiation exposure of patient and acceptable image quality.

Due to inter-relationship between beam attenuation, μ , and half value layer (HVL), x-ray beam energy is usually determined by the HVL measurements. HVL is the quantity used for measuring the ability of radiation to penetrate specific objects. In measuring HVL the two items required are an instrument for measuring radiation exposure and a set of aluminium (Al) filters. Typical Al set includes absorbers with thicknesses in the range of 0.5 mm - 1 mm. Absorbers of different thickness are placed in the path of x-ray beam and an exposure reading is made for each thickness. Dividing each exposure reading by the exposure with no absorber gives the penetration for each thickness of absorber. The absorber thickness corresponding to a penetration value of 0.5 is the HVL.

2.3.2 BEAM FILTRATION

As the heterogeneous beam of x-ray passes through material, their penetration varies with their individual energy. This selective attenuation of photons with respect to their energy is referred to as filtration. Filtration consists of inherent and added aspects. The total filtration of an x-ray tube is the sum of the inherent and the added filtration. Inherent filtration is the internal casing of the tube, it is fixed and always present in the x-ray tube. The added filtration (removable filter) on the other hand, is usually Aluminium ($Z = 13$) and it is removable. The total filtration is usually between 1.5 – 2.5 mm. The maximum kVp will determine the added filtration value. Filtration of x-ray beam is required in diagnostic x-ray procedures for eliminating low energy x-

rays (unwanted beam) from x-ray spectral before entering the patient. This is because low energy x-ray beam does not contribute to image formation but increase radiation exposure to patient. The resultant effects of filtration are alteration in the shape of x-ray spectrum and shift in the effective energy of the beam. Also, filtration increases the penetration of an x-ray beam. The filtration material normally used for this purpose is Aluminium. The total amount of filtration in a given x-ray machine is generally specified in terms of an equivalent Aluminium thickness.

Regulations that specify filtration requirement generally state a minimum acceptable HVL value. Typical values are shown in Table 2.1 below. It is assumed that if an x-ray beam has the minimum specified HVL value at a stated kVp, the filtration is adequate (Perry, 1987).

Film radiography x-ray unit are required by regulations to contain a total filtration of at least 2.5 mm of Aluminium filter or equivalent, if the machine would be operated at tube potentials greater than 70 kVp (NCRP report 102, 1989). Filter of this thickness (2.5 mm Al) or equivalent is considered appropriate for removing x-rays of energy below 70 kVp from the beam. HVL values are used to judge the adequacy of beam filtration.

Table 2.1 Recommended Minimum Penetration (HVL) for various kVp values (Perry, 2011)

kVp	Minimum penetration (HVL) for Aluminium (mm)
30	0.3
50	1.2
70	1.5
90	2.5
110	3.0

2.3.3 COLLIMATION

Collimator is a moveable device on the lower part of an x-ray tube (figure 2.4) through which the beam of x-rays are emitted. It is also known as x-ray window. The amount of x-ray beam that would pass through the collimator is determined by the thickness of the patient and the area (field size) being examined. The amount of scattered radiation present during an examination procedure is a function of the collimator size. Increase in collimator size would increase scattered radiation and reduce image contrast. One of the ways by which scatter radiation is minimized to improve image contrast is to reduce field size through the collimators. However, this is limited by the necessity to cover a specific anatomical region. Therefore, in clinical radiographic procedures, the collimator is adjusted in such a way that the exposed area of the patient corresponds to the area under examination. By this practice, exposure of patient to unwanted radiation and the scattered radiation that could affect the image quality are greatly reduced.

2.3.4 ANTI-SCATTER GRIDS

A grid is made up of alternate strips of x-ray absorbing material, such as lead, and relatively non-absorbing inter-space material, such as fiber, carbon, or aluminium. In majority of x-ray examinations, the most effective and practical way of removing portions of scattered radiation from the primary beam is to use grids. The grid is usually placed between the patient and the receptor. Since the direction of x-ray beam is aligned with the grid, majority of the primary beam of radiation passes through the interspaces without encountering the lead strips. On the other hand, the scattered radiation leaves the body of the patient in a direction different from that of the primary beam. Since the scattered radiation is not generally lined up with the grid strips, a large portion of it is absorbed by the grid. The ideal grid would absorb all scattered radiation and allow only primary x-rays to pass through to the receptor.

Unfortunately, there is no ideal grid, as the grids absorb some of the primary x-ray beam it also allows some scattered radiation to pass through to the receptor. The part of primary beam that is absorbed by the grid leads to reduction in the total amount of radiation required at the image receptor for a good image quality. In order to compensate for this beam reduction in film radiography procedure, the operator usually select the exposure parameters that would increase the amount of radiation incident on the grid and this often resulted in increased radiation dose to patient. Although application of grids in diagnostic x-ray examination improves image quality, but it is at the expense of increased radiation dose to patients.

The typical dose of radiation received by patient during x-ray examination with the application of grid is about two to five times higher than those encountered without the use of grid (Ionizing Radiation Regulations, 1988).

2.3.5 SIZE OF THE PATIENT

This is the thickness of the section of the body presented for x-ray examination. The density of the section of the body under investigation determines the quantity of x-ray beam that would be required to pass through the patient. As the thickness of the area under investigation increases, the incident x-ray beam required would also increase. Increasing radiation intensity would facilitate deep penetration of radiation beam through the section of the body under investigation and also improve image quality, but at the expense of increased dose to patient. The machine operator and the clinician have no control over the size of patients.

2.3.6 FILM - SCREEN COMBINATION

This is the combination of photographic film and intensifying screen in a single film cassette. The screen makes the image of the examined area of the patient, which is displayed on the photographic film, to be more visible after development. The principle behind combining the screen with photographic film is based on the fluorescence property of x-radiation. The choice of film and intensifying screen determines the radiation dose to patient (Ionizing Radiation Regulations, 1988). The

radiation dose received by patient from the most recent radiographic intensifying screens, rare earth, is less than those received from previously used, calcium tungstate screen.

The time taken by the intensifying screen to process an image is known as speed. Any speed value assigned to a screen is a relative value. For instance, a 400-speed system would need only half of the dose used by a 200-speed system to process an image whereas a 200-speed system would need half of the dose used by a 100-speed system to process the same image. In general, the use of fast film-screen combinations reduces dose to patient, but at the same time could lead to loss of image details. The typical fast screen systems in used (especially if the examination in question permits less details) is rare earth screens, with speed 600.

2.3.7 FILM PROCESSING CONDITION

Film processing condition is the overall chemical status of the film processor. Both the sensitivity and the contrast characteristics of a given film type are affected by processing. Film processing materials are developer and the fixer. The degree of processing received by film generally depends on three factors namely (i) the chemical activity of the developer solution, (ii) the temperature of the developer, and (iii) the period of immersion in the developer.

Both the developer and fixer are used for transforming latent image of the exposed area of patients to visible image on the photographic film. The film processing could be done with either manual or automatic processor. To achieve an optimal image quality, film processor should be operated according to the degree of development recommended by the manufacturer (Perry, 1987). If the processor temperature reading and replenishment rates of the developer and fixer differ substantially from the recommended values, it would have pronounced effects on the image quality.

Unacceptable image quality would automatically leads to repeat of the examination with or without modification of the exposure parameters. The overall effect of repeat of x-ray examination is increase in radiation dose to patient.

2.3.8 FOCUS-SKIN DISTANCE, FSD

The focus-skin-distance is the distance between x-ray source (focal spot) and the skin of the patient. According to inverse square law, radiation intensity, I , decreases as the square of the distance, d , from the radiation source increases ($I = 1 / d^2$). In clinical practice, FSD is chosen in such a way that the clinical information required from the examination is obtained at minimal dose to the patient.

2.3.9 X-RAY TUBE TARGET MATERIAL

The type of material make-up of the x-ray tube target could affect x-ray production. The interaction between electrons and atoms of the target materials determines the production of x-rays. Different target materials yield x-rays of different energies. A target material, which is capable of producing characteristic x-rays of energy in the range 45 kV – 150 kV, is usually employed in film radiography. The high energy x-ray beam produced is able to penetrate thicker medium, with minimal dose to the skin of the patient. The most widely used target material for conventional x-ray machine is Tungsten, which has an atomic number of 74.

In addition to high atomic number, tungsten is almost unique in its ability to maintain its strength at high temperatures. It has a high melting point and a relatively low rate of evaporation. For many years, pure tungsten was used as the target (anode) material but in recent years, an alloy of tungsten and rhenium has been used as the target material but only for the surface of some anodes (Perry, 1987).

2.4 RADIATION DOSE TO PATIENT AND ITS ASSOCIATED RISK

The risk associated with diagnostic x-ray examination is determined by the amount of radiation dose (effective dose) received by patient during the procedure. Risk is the probability of an undesired consequence of an event, such as radiation

exposure, within a specified period of time. Risk is defined as a quantitative function of exposure and biological effect (Rutherford, 2002). Some of the risks associated with radiation exposure are radiation sickness, cell damage, vascular damage, deaths and cancer induction.

Current radiation protection standards and practices (that is, the philosophy of radiation protection) are based on the premise that any radiation dose, no matter how small, can result in detrimental health effects, such as cancer and hereditary damage (Kenneth et. al, 1996). Although in radio-diagnosis, an optimally restricted field sizes and limited beam penetration are expected for a given examination, yet exposure of surrounding organs, which have relatively high degree for cancer inductions cannot be avoided in some instances. In such a situation, great care is taken to minimize the radiation dose to such critical organs.

2.4.1 RADIATION RISK MODELING

Several researches, from where risk models are formulated, had been conducted to improve the scientific basis of radiation risk assessment. The findings from these researches are used to develop highly effective management strategies for solving radiation related problems (NAP, 2006). One of the recent developments in radiation protection researches, which has implication for risk assessments is the use of mathematical models for cancer induction/formation. These models are based on a multistage mechanism. In addition to meeting the requirements for being the primary purpose of representing radio-epidemiologic data, these models also conform to the established radio-biologic principles.

However, in the current cancer risk model, the risk estimates obtained are in apparent conflict with radio-biologic principles in two main aspects namely the shape of the dose-response curve (linearity Vs curvilinearity) and dependence of Radio Biological Effectiveness (RBE) on doses. These conflicts are expressed to verify whether the occurrence of excess cancer rates is threshold dependence or linear no-threshold dependence.

2.4.2 LINEARITY VS CURVI-LINEARITY (NON LINEARITY) OF DOSE-EFFECTS RELATIONSHIP

One of the major disagreements between radio-biologic observations and estimates of the current risk model is the shape of the dose-response curve for gamma radiation. In the majority of radio-biologic observations of specimen after photon irradiation, the dependence of cancer induction on dose is found to be curvilinear which is often described as linear-quadratic dependence. However, between low to moderate doses ($\ll 2$ Gy) of radiation, there is no apparent deviation from linearity in the excess rates of solid cancer among the atomic-bomb survivors, which were the primary source of risk estimates. As a result of this finding, in current models, dose proportionality is used instead of linear-quadratic dose dependence. However, the International Commission on Radiological Protection (ICRP, 1991) resolved the argument by declaring that linear dependence of cancer induction/development on radiation dose is inconsistent with radio-biologic findings. That means, the dependence of cancer induction on radiation doses is linear-quadratic in shape.

2.4.3 LINEAR NON THRESHOLD DOSE MODEL (LNT)

The linear non threshold model (LNT) is a model used to express the detriment caused by ionizing radiation. The model proposed that the response of a biological medium to radiation exposure is linear (i.e. directly proportional) at all levels of dose, no matter how small the exposure is. Thus LNT asserts that there is no threshold of exposure below which the response ceases to be linear. The LNT Model stands in contrast to theories, which states that below a certain radiation level, radiation is harmless or that there is a threshold dose for radiation damage. One of such theories is *radiation hormesis*, which states that radiation is beneficial at very low doses but harmful at large doses.

For the purpose of radiological protection, the assumption of LNT model is that the underlying dose-response relationship is linear-quadratic with no threshold dose (NCRP, 2002). From the epidemiological point of view, the dose-response

relationship for leukaemia is linear-quadratic while for solid tumours, the response is consistent with linearity down to about 100 mSv.

LNT model was initially rejected by the United States Department of Energy (USDOE) because they felt it was “inconvenient” (Gofman, 1994). In order to put the record straight, the report published by the National Academy of Sciences (National Academies Press, 2006) declared that there is no safe level of radiation. Earlier reports had presented equivocal and inconclusive discussions on the issue (National Research Council, 2005).

2.4.4 CONTROVERSY ABOUT LNT MODEL

In recent time, the accuracy of the LNT model at low dose of radiation has been questioned. Many believed that when radiation is distributed uniformly within a biological medium such that its intensity is comparable to natural/background level, then it would have no harmful health effects on the medium.

The United Nations Scientific Committee on the Effects of Atomic Radiation (UNSCEAR) in its most recent report (UNSCEAR 2000) stated that “Until the uncertainties on low-dose response are resolved, an increase in the risk of cancer induction which is proportionate to radiation dose is reasonable with developing knowledge and is the most scientifically acceptable approximation of low-dose response. However, a strictly linear dose response should not be expected at all circumstances”.

The risk coefficient published by the ICRP (ICRP, 1990), being widely accepted at the time of this study, was used to estimate the risk associated with diagnostic x-ray examinations at four different diagnostic centres in Nigeria.

2.5 RADIATION RISK QUANTITIES

Some of the measurable quantities that could be used to estimate radiation risk in diagnostic x-ray examinations and especially in film radiography are itemized below:

- i. Incident Air kerma/Exposure
- ii. Dose-area product (DAP)
- iii. Entrance Skin Dose (ESD)
- iv. Energy imparted
- v. Organs' absorbed dose
- vi. Effective dose

Of all these itemized quantities, the effective dose is the preferred quantity for estimating radiation risk in most medical x-ray examination studies. This is because effective dose accounts for distribution of dose among the radiosensitive organs of the exposed person by summing up their individual doses, having weighted each organ according to its relative sensitivity to radiation effect (Wall, 1997; Broerse and Geleijns, 1998). In addition to this property, effective dose allows the complex dose pattern within the body to be expressed in terms of a simple quantity that is roughly proportional to the probability (risk) of radiation harm.

2.6 RADIATION RISK ESTIMATES

The exact risk of cancer associated with radiation exposure can not be obtained but could be estimated to a reasonable extent. This estimation is based on various studies conducted on the people, who developed cancer, after radiation accident, such as in Hiroshima and Nagasaki (Wanebo et al, 1968) or after medical exposure to radiation (Shope, 1996). There are many scientific groups, who had carried out studies on the estimation of risk associated with radiation exposure. Their results are similar but not the same because of different methods and assumptions used by each group.

From the study published by the Biological Effects of Ionizing Radiation Committee V (National Research Council, 1990), the risk of cancer from low level radiation exposure was estimated to be 0.8 % per mSv for doses received rapidly (acute) and 0.4 % per mSv for doses received over a long period of time (chronic).

These are averaged values for all ages, sexes, and all types of cancer. However, in the updated version of BEIR report (National Research Council, 2005), the incident rate of fatal cancer was estimated to be 5 % per Sv.

Due to varying radiosensitivity of different tissues in humans to radiation damage, the probability coefficients of fatal cancer ($5 \times 10^{-2} \text{ Sv}^{-1}$) were further broken down among 22 different tissues, with values relative to their sensitivity to develop cancer and these are presented in Table 2.2.

UNIVERSITY OF IBADAN

Table 2.2 **Probability coefficient of cancer with respect to human tissues/organs**

Tissue/Organ	Probability coefficient of cancer (10^{-2}Sv^{-1})
Red bone marrow	0.50
Colon	0.85
Lung	0.85
Stomach	1.10
Bladder	0.30
Breast	0.20
Liver	0.15
Oesophagus	0.30
Thyroid	0.08
Skin	0.02
Bone surface	0.05
Remainder	0.50
Sum	5.00

2.7 DETERMINATION OF RADIATION DOSE TO ORGANS AND EFFECTIVE DOSE FROM RADIATION EXPOSURE

When different tissues interact with ionizing radiation, the observable biological responses differ. When any part of the body is exposed to radiation, the stochastic effect experienced by the tissues involved is a function of the density of the tissue and equivalent dose received. The risk associated with this exposure is best expressed by effective dose, a quantity that is related to an equivalent whole body dose (University of Leeds Regulations, 1988). Measurement of effective dose requires summation of radiation doses to several organs in the body. In routine radiological procedures, it is not practical to conduct in-vivo measurements of radiation doses to about 25 organs present in a patient. To facilitate measurement of effective dose to a reasonable accuracy, there are several methods in literatures by which effective dose incurred from diagnostic x-ray examinations could be estimated (Nicholas, 2001). Some of these methods are discussed in the following sub sections:

2.7.1 THE USE OF CONVERSION COEFFICIENT CHARTS

These coefficients were published by the National Radiological Protection Board (NRPB). The conversion coefficient contained in the charts is a function of beam filtration and applied voltage, for a given radiation exposure. The product of conversion coefficient and either of entrance surface dose or dose-area product, both measurable from diagnostic x-ray procedures, gives the effective dose for a given x-ray examination. Access to these conversion coefficient charts is limited at the time of this study.

2.7.2 DIRECT DOSE MEASUREMENT WITHIN A RANDO ANTHROPOMORPHIC PHANTOM

This is an in-vivo measurement with the use of thermoluminescence dosimeters (Lithium (TLD-100) or Calcium Fluoride (TLD-200)) chips within a Rando phantom. Prior to the use of TLD chips, they have to undergo calibration against a 3 cm³ Radcal ionization chamber on the radiographic x-ray unit at various applicable tube voltages. The exposed chips would be processed and annealed by an appropriate TLD reader, such as Victoreen 2800-M. The TLD signal obtained from the reader would be converted to absorbed dose using the calibration factor previously obtained. To be able to use this method to determine effective dose, the materials would be required include Rando phantom, TLD-100 or TLD-200, appropriate TLD reader, ionization chamber and x-ray machine. Also, this method required that all the organs represented in the phantom are appropriately loaded with calibrated TLD chips in order to measure their respective dose to the organs. Thereafter, the effective dose is calculated using equation (1.4). However, this method is very expensive, labour intensive and the outcomes are limited to the specific phantom and irradiation conditions. Therefore, the use of this method for this present study was not feasible.

2.7.3 THE USE OF SOFTWARE PROGRAM, XDOSE

XDOSE software program was developed by J.C. Leron (Leron, 1992). This software incorporated all the data on organ doses published by the National Radiological Protection Board, NRPB. The input data needed to run the program include tube voltage (kV), tube filtration and either incident radiation beam, expressed as entrance skin dose (ESD) or dose area product (DAP). A summary report of the computation generated by this software program includes radiation doses to organs and effective dose. The major materials required in this method are the software program, XDOSE, and the ratio (or conversion coefficient) ESD/DAP values. Due to financial constraint, the license to use the package could not be obtained.

2.7.4 ESTIMATION FROM IMPARTED RADIATION ENERGY

Atherton and Huda (Atherton, 1996) published their findings on the estimation of effective dose from radiation energy imparted to patients. The energy imparted to patient during medical radiological exposure was calculated from the incident entrance exposure area product (EAP). The entrance area product ($R\text{ cm}^2$) was derived from DAP through a conversion factor of 87.7 R/Gy. The limitation of this method is its inability to calculate readily observable dose to organs.

2.7.5 THE USE OF DOSE AREA PRODUCT (DAP) METER

In a study by Viktorie and Stisova (Viktorie and Stisova, 2004), the effective dose to patient during cardiac radiography procedures was assessed by the use of DAP meter. Measurements of effective dose were performed on 85 patients drawn from three different hospitals in Prague using the dose area product (DAP) meter. The main equipment for this method, DAP meter, costs about a million naira and this amount is beyond the budget of this present study.

2.7.6 THE USE OF COMPUTER MODEL

This computer model was developed by Hart D. (Hart et al, 1994) to estimate radiation dose to organs and effective doses in adult patient during medical x-ray examination. The Monte Carlo algorithm was used in this model to estimate effective dose received by a mathematical phantom. This represents an average adult patient, during radiation exposure in different radiographic projections. Unfortunately, this package was not available for general applications; hence it could not be used in this present study.

2.7.7 THE USE OF PERSONNEL RADIATION DOSE CALCULATION (PRDC)

This package, developed by Chan-Hyeong Kim (Chan-Hyeong et al, 2005), is used by the authors to calculate effective dose, radiation doses to various organs/tissues and radiation dose absorbed in personnel monitoring dosimeters through series of interpolations. The package uses a human body model (phantom) and advanced computer code to transport radiation dose within and around the phantom.

PRDC performs series of interpolations among radiation energies, radial distances, polar angles and azimuthal angles. The package calculates organ/tissue doses, effective dose and personnel doses within a few seconds. This package was found to estimate effective dose within the accuracy of 15%. However, at the time of this study, the package could not be accessed.

2.7.8 THE USE OF THE QUANTITY, DOSE AREA PRODUCT (DAP)

In a study conducted by JC LeHeron, where organ dose data were obtained from Monte Carlo modeling to determine the relationship between effective dose and quantities such as entrance surface doses, entrance air kerma and dose-area product, for common radiographic projections. JC LeHeron found out that dose area product (DAP) is the best quantity for estimating effective dose (JC LeHeron, 1992). The combination of DAP and a given conversion coefficients gives an estimate of the effective dose to a reasonable accuracy. It was observed that for cervical spine, chest, kidneys, abdomen, lumbar spine and pelvis AP projection, the conversion coefficient of 0.21 mSv per Gy cm² estimated effective dose within 30%. DAP values is one of the input quantity used in this study to compute effective dose.

2.7.9 THE USE OF MONTE CARLO (MC) BASED SIMULATION

This method, commonly used in Radiation Medicine (Radiology, Radiotherapy and Nuclear Medicine), is based on Monte Carlo simulation. It is used to simulate interaction between radiation and human tissues or organs. From the simulation processes, the radiation doses to the organs of patient and effective doses are calculated. This method requires the use of human equivalent phantom, mathematical algorithm or MC code and a computer system. The MC code available for organs dose calculations in Radiation Medicine are Electron-Gamma Shower (EGS4), Monte Carlo N-Particle Transport Code (MCNP), Voxel Monte Carlo (VMC), Personal Computer X-ray Monte Carlo (PCXMC) etc. The MC code that is applicable to film radiography, which is the focus of this present study, is the PCXMC. This package was used to compute the effective dose received by patients during diagnostic x-ray examination.

2.8 MONTE CARLO THEORY

The Monte Carlo (MC) method has long been recognized as a powerful technique for performing certain calculations, generally too complicated for a more classical approach. Since the use of high speed computers became widespread in the 1950s, a great deal of theoretical investigation has been undertaken and practical experience has been gained in the Monte Carlo approach (James, 1980).

A MC technique is any technique making use of random numbers to solve a problem. Monte Carlo method is defined as representing the solution of a problem as a parameter of a hypothetical population and using a random sequence (simulation) of numbers to construct a sample of the population from which statistical estimates of the parameter can be obtained.

In many applications of MC method, the physical processes of the problem, often described by probability density functions are simulated directly by random sampling. Many simulations or multiple trials (or histories) are then performed on these probability density functions and the desired result is taken as an average over the total number of observations.

Another MC approach to solving problem is by designing a model of an object interacting with another object or objects interacting with their environment. This is carried out on the basis of the most essential and simple object-object or object-environment relationship. The numerical solution is determined by random sampling of these relationships and iterating until the result converges.

MC method encompasses all techniques that deal with statistical simulation of some underlying system, which may or may not be represented by physical processes. MC method provides flexibility in solving problems and has the potential to handle multiple sources of uncertainties. MC could be applied in various disciplines, such as Science, Radiation Medicine, Engineering, Economics etc., to solve specific problem but the algorithm required in each case differs.

Some of the essential items that could be used to perform MC simulations are shown in figure 2.8.

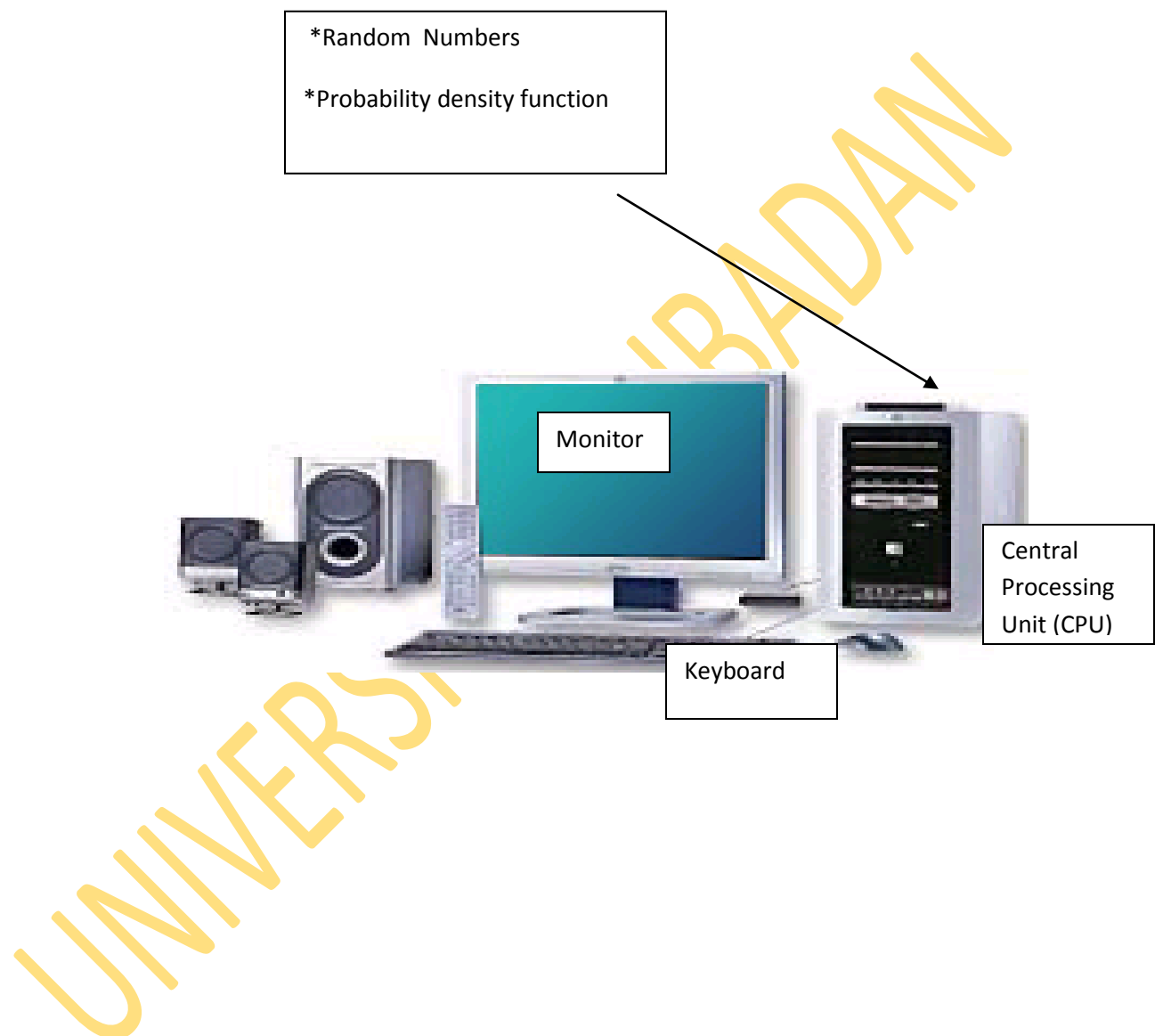

Fig 2.8 Monte Carlo Technique

The sketch in figure 2.8 shows a box containing input data needed for simulation. These are random numbers, which are generated according to probabilities functions, assumed to be associated with the problem. They are fed into a high-speed computer and the results of simulation are thereafter displayed on the monitor.

2.8.1 *MONTE CARLO (MC) SIMULATION*

Simulation is a procedure in which random numbers are generated according to probability functions assumed to be associated with a source of uncertainty/problem. The outcomes of random drawings of these numbers are then analyzed to determine the likely solution to the problem.

MC simulation involves generation of series of configuration of particle in such a way that the configurations are distributed in phase space according to some prescribed probability density functions. MC technique is used to simulate complex physical phenomena such as radiation transport in the earth's atmosphere, simulation of the esoteric sub-nuclear processes in high energy physics experiments and for simulation of photons (x - or γ - ray) transport in human tissue/biological medium.

Monte Carlo simulation of photon interactions with biological medium within a simplified mathematical model of the human body (or tissue) is the method commonly employed for estimating radiation doses in Radiation Medicine (Radiology, Nuclear Medicine and Radiotherapy). This allows radiation doses absorbed by various organs and tissues of patient during medical radiation exposure to be determined.

MC simulation process requires availability of MC software programs. There are several MC application packages but the one to choose depends on the task at hand. Each package provides the algorithm for simulation while the users specify the source of radiation (or radiation type) and source geometry (point or line). Some of these packages are Electron Gamma Shower (EGS), Monte Carlo Neutron-Photon code (MCNP), Visual Monte Carlo (VMC) and Personal Computer X-ray Monte Carlo (PCXMC), which was used in this study to estimate radiation doses to organs of patients during diagnostic x-ray examinations.

When performing MC simulation of radiation transport in a biological medium for instance, the typical sequence of events (flow chart), that could occur are shown in fig. 2.8 below. In this flow chart, the source of radiation was foremost specified. This is followed by definition of the source geometry and composition of all the media likely to interact with the radiation within the medium. Next to this is, stating the condition for a particular interaction process to take place in terms of cross sectional data and rules governing photon interactions with matter. The algorithms for transporting the specified radiation through the defined media are thereafter formulated and radiation particles behavior through each medium are sampled and recorded accordingly.

UNIVERSITY OF IBADAN

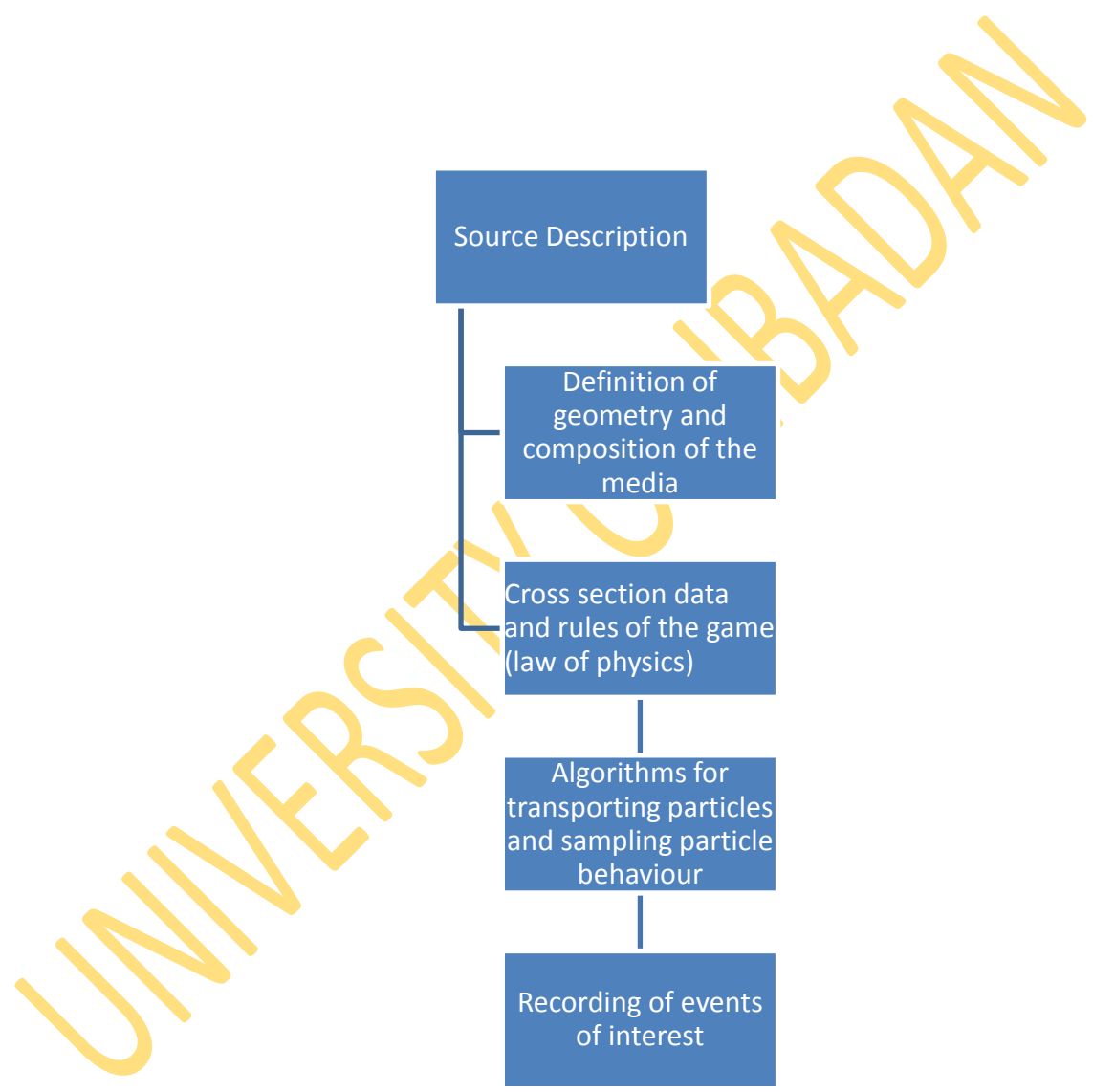

Fig 2.9

MC SIMULATION FLOW CHART

2.8.2 *MONTE CARLO (MC) ALGORITHM*

Monte Carlo Algorithm is a set of procedures specifying how a particular problem would be solved. The procedures itemized in this section are examples of algorithm written to simulate trajectory of x-ray photons through a medium. These procedures are:

1. Select a photon at random
2. Calculate its initial energy, E_0
3. Give the photon a random displacement or transportation through a medium. This transportation could lead to either of the two processes: photon scattering or absorption in the medium. Let this be represented as:
Transportation (t) = Scattering (s) + Absorption (a)
4. From these two processes, calculate the total cross section or attenuation and mean free path, λ , of photon through the medium that is:
 - a. total cross section $\Sigma_t = \Sigma_s + \Sigma_a$
 - b. mean free path $\lambda = 1/\Sigma_t$
5. Calculate the new energy of photon or the remaining energy, E_1
6. Determine the possible reaction or process (scattering or absorption) that the remaining photon energy could undergo
7. Repeat steps 3 – 6 or go to step 8
8. Stop when E_1 equals to a certain minimum value, far less than what is needed to undergo any of the possible reactions.
9. Compute the radiation energy deposited in each section of the medium.

2.8.3 *PERSONAL COMPUTER X-RAY MONTE CARLO (PCXMC) PROGRAM, VERSION 1.5*

In this study, MC software application program, PCXMC, was used for simulating radiation dose deposited in various organs and tissues of patients during diagnostic x-ray examinations of various parts of the body.

PCXMC application software was developed by the Radiation and Nuclear Safety Authority (STUK), Finland in the year 1997. It was designed for calculating organs doses and the effective doses to patient during medical diagnostic x-ray examinations. The program uses mathematical hermaphrodite phantom models of Cristy (Cristy, 1980). The phantom is adjustable to mimic patients of an arbitrary weight and height. The program computes organ doses for patients of six different ages (new born, 1, 5, 10, 15-year-old and adult) and their respective sizes in freely adjustable x-ray projections (AP, PA and LAT) and other examination conditions commonly encountered in film radiography and fluoroscopy procedures. The program was written in Delphi Object Pascal Code and runs in a personal computer under window operating system versions 95/98/2000/XP.

Monte Carlo calculation of x-radiation transport is based on stochastic mathematical simulation of interactions between photons and matter. The program assumes that photons are emitted (in a fictitious mathematical sense) iso-tropically from a point source into the solid angle specified by a given focal distance and x-ray field dimensions. These photons are monitored while they interact with the phantom according to the probability distributions of the physical processes (probability density function) that could take place within the phantom, as earlier mentioned in section 3.1. These processes include photo-electric absorption, coherent (Rayleigh) scattering or incoherent (Compton) scattering. Other interactions, such as pair production, are not considered in PCXMC, because the maximum photon energy employed in medical diagnostic x-ray examination does not exceed 150 keV.

During simulation, a large number of individual photon histories are generated and estimates of the mean values of energy deposited in the various organs of the phantom are used for calculating radiation doses in each organ. The organs, whose radiation doses are calculated by the PCXMC program, include active bone marrow,

adrenals, brain, breast, colon (upper and lower large intestine), gall bladder, heart, kidneys, liver, lungs, muscle, oesophagus, ovaries, pancreas, skeleton, skin, small intestine, spleen, stomach, testes, thymus, thyroid, urinary bladder, uterus and others.

The program runs by using a multiplicative linear congruential generator (MLCG) to generate pseudo random numbers. The random numbers generated are used for sampling the following interaction parameters: initial photon direction, interval between interactions, types of interacting atom (or atomic density), types of interaction process, scattering angle and photon energy. Photon energy determines the type of interaction (photo electric or Compton) it would undergo.

In order to improve precision of programming results, photons are constrained such that those that are meant to undergo photon scattering did not undergo photo-electric absorption. This is achieved by associating a 'weight (w)' to photons meant to undergo photo-electric absorption. The weight represents the expected proportion of photons that would have survived absorption in the preceding interactions. The weight is reduced in each interaction according to the probability, p, of absorption coefficient.

At each interaction, an amount of radiation energy, E, deposited in the organ is given by the equation:

$$E = wpE_0 - w(1-p)\Delta E_0 \quad (3.1)$$

where, E_0 is the photon energy before interaction and ΔE_0 is the energy of scattered photon after interaction.

As this energy, E_0 , is deposited at the site of interaction, the weight of the photon is reduced according to the relation shown below:

$$W_{new} = W_{old}(1-p) \quad (3.2)$$

At the onset of interactions, each photon is monitored until its energy is reduced to about 2 keV or its accompanied weight is reduced to about 0.003. In either case, most photon loses their energy to the medium.

The PCXMC calculates organ doses for monochromatic photons of energy in the range of 10 - 150 keV, in ten different batches of each energy value. The final estimate of the absorption at each energy value is obtained as the average of these batches, and statistical error is estimated from their standard deviations. The same MC data can be used to calculate radiation doses for any energy spectrum of interest. The calculated organ doses reported by PCXMC for a particular x-ray energy spectrum usually include estimated statistical errors. A high estimated statistical error for any organ in a reported result is an indication that few interactions took place between the photon and that particular organ.

The program uses x-ray information supplied by the users during computation process to specify the spectrum of x-ray beam. Some of this information includes x-ray tube voltage (kV), angle of tungsten target and tube filtration. The users also supply the atomic number and thickness of filtration material present in the x-ray tube. Lastly, the program requires the users to input dose area product (DAP) value for the computation of organs doses, surface dose and effective dose for a particular examination. At the end of PCXMC computation program, a summary report of the computation is generated and displayed on the computer monitor.

CHAPTER THREE

MATERIALS AND METHOD

3.1 INTRODUCTION

As stated in section 1.9.2, the main objective of this study is the estimation of risk to which a patient is exposed to after a single film radiographic exposure. This could only be done by representative sampling of over one thousand diagnostic x-ray centres which are located at different parts of Nigeria for clinical services of about 150 million populations.

Discussed in this chapter are the rationale behind the choice of the diagnostic centres selected for this study, description of the centre and its x-ray machine, number of patients selected from each centre, x-ray machine exposure parameters, measurements of x-ray beam output, determination of dose area product and computation of effective dose using a computer package namely, PCXMC 1.5 (Servomaa and Tapiovaara, 1998). The period of data collection for this study is between the year 2004 and 2006.

3.2 SELECTION OF DIAGNOSTIC CENTRES

Based on their location, year of existence as diagnostic centre, and the number of patients catered for on an annual basis, four foremost diagnostic centres namely the University College Hospital (UCH), Ibadan, TwoTees Diagnostic x-ray centre (TDC), Ibadan, Obafemi Awolowo University Teaching Hospital Complex (OAUTHC), Ile-Ife and National Hospital Abuja (NHA) were selected for this study.

For each patient selected in each of the diagnostic centre considered in this study, the following parameters were recorded namely; sex, age, weight, height, body mass index, focus-to-film distance, field size, kVp and mAs. Body mass index (BMI), derived from $\text{weight}/(\text{height})^2$, is a useful classification scheme for the size and shape of a person (Gibson, 1990).

The layout of x-ray room, which housed the x-ray machine and radiographic accessories in all the centres considered in this study is similar in structure but the position of each radiographic accessories with respect to x-ray tube/couch differs in each centre. Some of these radiographic accessories are radiographic film holder, dark room, operator stand, changing cubicle and others.

All x-ray examinations performed at these centre during the period of this study (2004 – 2006) were classified according to the region of the body exposed to ionizing radiation. The classification of the body and its constituent organs (in bracket) includes head and neck (brain, paranasal-sinus, cervical spine), upper limb (shoulder), thoracic (chest, thoracic vertebrae), abdomen (abdomen), pelvic (pelvis, lumbar spine, hip) and lower limb (thigh, leg). In all the diagnostic centres considered in this study, the repeat rate analysis of radiographic films was also assessed. That is, the rate at which the x-ray examination of any of the listed body regions is repeated.

The brief descriptions of centres considered in this study are discussed as follow:

3.2.1 RADIOLOGY DEPARTMENT, UNIVERSITY COLLEGE HOSPITAL (UCH), IBADAN

The University College Hospital (UCH), Ibadan is the oldest teaching hospital in Nigeria. UCH Ibadan is also known as the Nigerian Premier University Teaching Hospital. It was established by the act of parliament 26 of 1952 and commissioned in the year 1957.

The Department of Radiology, where this study was carried out, is one of the clinical departments at the Nigerian Premier University Teaching Hospital, Ibadan. The department has two main units namely in-patient and out-patient. The in-patient unit caters for patients on admission while the out-patient unit caters for all other patients. At the time of this study, the in-patient unit has 2- units of x-ray machine and a darkroom while the outpatient unit, where this study was carried out, has one unit of x-ray machine and one darkroom with a manual processor.

The model of x-ray machine at the out-patient unit is Roentgen 501 and was installed in the year 1974. This implies that its age at the time of this study was 30 years. The total filtration in the x-ray tube was 1.7 mm Al. The thickness of filtration material in the tube determines the quality of x-ray beam.

The Department has no quality control equipment of its own at the time of this study but made use of the one available at the Radiotherapy Department of the same hospital. Also, at the period of this study, there is no Medical Physicist assigned to Radiology department. The Medical Physicist assigned to Radiotherapy Department does the annual quality control measurements on all the x-ray machines in the hospital.

At the time of the study (2004 – 2006), there are 18 Radiographers and 6 consultants (Radiologists) at the Department catering for about 40, 000 patients per annum. The University College Hospital, being a training centre is involved in the training of medical and allied professionals such as resident doctors, radiographers and nurses.

The number of patient selected from UCH was three hundred and ten (310). This comprises of one hundred and seventy three (173) male and one hundred and thirty seven (137) females. The age of each patient was obtained from the patient's hospital card. The weight and height were measured with Hanson weighing scale and tape rule respectively. The thickness of the region of the body, where x-ray examination is required, was measured with plastic metre rule prior x-ray examination. All these data were recorded alongside with the x-ray exposure parameters (kVp and mAs) for each patient.

3.2.2 TWOTEES DIAGNOSTIC X-RAY CENTRE (TDC), YEMETU IBADAN

TwoTees diagnostic x-ray centre is one of the private x-ray centres in Ibadan. It is located at Yemetu area of Ibadan in Oyo state. It is one of the referral x-ray centres for patients managed in many health care centres at Ibadan. At the time of this study (2004 – 2006), most newly admitted undergraduate students from the University

of Ibadan were referred to this centre for routine chest x-ray examination. This examination is required for health clearance of students.

The centre has 2- units of x-ray machine. One of them is used for general purposed radiography while the other is for special procedures. The general purposed x-ray machine was used for this study and its model number is Roentgen 201. This machine was installed in the year 1998 and has a total tube filtration of 2.7 mm Al. The centre used automatic processor for the processing of all radiographic films.

The centre does not have a resident Medical Physicist, but a consultant Physicist, who does the quality control measurements on the x-ray machine on an annual basis. This is in agreement with the mandate of the Nigerian Nuclear Regulatory Authority (NNRA). During the period of this study, the centre has three Radiographers and 2 consultants Radiologists. The workload at the centre is about 5,000 patients per annum.

The number of patient selected from TDC was two hundred and seventy six (276). This comprises of one hundred and sixty four (164) male and one hundred and twelve (112) females. The age of each patient was obtained from the hospital card while the weight and height were measured with Hanson weighing scale and tape rule respectively. The thickness of the region of the body, where x-ray examination is required, was measured with plastic metre rule prior radiation exposure. All these data were recorded alongside with the x-ray exposure parameters for each patient.

3.2.3 DEPARTMENT OF RADIOLOGY, OBAFEMI AWOLowo UNIVERSITY TEACHING HOSPITAL COMPLEX (OAUTHC), ILE-IFE

The Obafemi Awolowo University, Ile-Ife was founded in the year 1962 as the University of Ife but rechristened by the Federal Military Government as the Obafemi Awolowo University on May 12, 1987, in honour of one of its most distinguished founding fathers and eminent nationalist, politician, lawyer, statesman and former Chancellor of the University, Chief Jeremiah Obafemi Awolowo.

Department of Radiology, where this study was conducted, is one of the Departments in the Faculty of Clinical Sciences in the College of Health Sciences. The Department has 2- x-ray units and one of them was used for this study. The x-ray

machine selected for the study is a general purpose Shimadzu model R-20 x-ray unit. It was installed in the year 1981. The x-ray tube has a total filtration of 1.7 mm Al. The photographic film processing at this centre is done manually. The Department does not have resident Medical Physicist. At the time of this study (2004 – 2006), the centre has ten Radiographers and 5 consultants Radiologists. The workload at the centre is about 6,000 patients per annum. The number of patient selected from OAUTH was two hundred and twenty (220). This comprises of one hundred and thirty (130) male and ninety (90) females. The age of each patient was obtained from the hospital card while the weight and height were measured with Hanson weighing scale and tape rule respectively. The thickness of the region of the body, where x-ray examination is required, was measured with plastic metre rule prior x-ray examination. All these data were recorded alongside with the x-ray exposure parameters for each patient.

3.2.4 DEPARTMENT OF RADIOLOGY, NATIONAL HOSPITAL, ABUJA (NHA)

National Hospital, Abuja was originally designed to cater for the needs of women and children in Nigeria and the West Africa sub-region with a view to reduce morbidity rates, and to carry out extensive research into the peculiar causes of women and children-related diseases in Africa.

After the recruitment of manpower from home and abroad, the hospital commenced operations on 1st September, 1999. In order for the vast majority of Nigerians to benefit from the services and modern equipment in the hospital, the scope of its operation was expanded to accommodate male patients. The hospital which was initially christened ‘National Hospital for Women and Children’ was renamed ‘National Hospital Abuja’ on 10th May, 2000.

The department of Radiology, where this study was carried out, is one of the clinical services of the hospital. The primary role in the department is to provide optimal radiological and imaging diagnostic services for patients with diseases affecting any part of their body.

The x-ray machine selected at the centre for this study is one of the state-of-the-art unit, Philips Optimus. It was manufactured and installed in the year 1999. The x-ray tube has a total filtration of 1.0 mm Al + 0.1 mm Cu. The photographic film is processed automatically.

The National Hospital Abuja has Medical Physics department. This was established to strengthen the safe and effective application of advanced technology to the diagnosis and treatment of diseases. The department carries out periodic and scheduled quality control tests and quality assurance of the high technological facilities installed in the hospital.

At the time of this study (2004 – 2006), the centre has 6 Radiographers and 5 consultants Radiologists. The workload at the centre is about 4,000 patients per annum. The number of patient selected for this study was two hundred and twenty eight (228). This comprises of one hundred and twenty four (124) male and one hundred and four (104) females. The age of each patient was obtained from the hospital card while the weight and height were measured with Hanson weighing scale and tape rule respectively. The thickness of the region of the body, where x-ray examination is required, was measured with plastic metre rule prior x-ray examination. All these data were recorded alongside with the x-ray exposure parameters for each patient.

3.3. ***RADIOGRAPHIC TECHNICAL DATA OF X-RAY MACHINES***

For each x-ray machine considered in this study, specific data such as type of x-ray tube and generator, model, filtration and year of installation were recorded. These technical specifications were obtained from the manufacturer's manual available at each centre and are presented in Table 3.1.

Table 3.1: Radiographic Technical Data of X-ray Machine

X-ray centre	X-ray machine parameters			
	X-ray tube & generator	Model	Total filtration (mmAl)	Year of Installation
UCH	Roentgen 501	CK 3415	1.7	1974
TDC	Roentgen 201	R 3149	2.7	1998
OAUTHC	Shimadzu	R-20	1.7	1981
NHA	Philips Optimus	98011519	1.0 + 0.1 mmCu	1999

3.4 ***X-RAY EXPOSURE PARAMETERS***

The term, exposure, is the quantity commonly used to express the amount of radiation delivered to a point. The amount of radiation delivered to a patient during diagnostic x-ray examination is determined by the following adjustable radiographic factors:

3.4.1 *Tube Voltage, kV.* This is used to describe the energy and penetrating ability of x-ray beams. Increases kV increases the penetration of the x-ray beam (beam quality) and so reduces image contrast. If all other exposure factors (mAs) are constant, the patient dose would increase roughly with the square of kV as shown in equation (2.1). In clinical practice, when kV is increased, it is usually possible to reduce mAs.

3.4.2 *Tube Current, mA.* This is the current that is responsible for heating the cathode for the emission of electrons from the filament in a process known as thermionic emission. The X-ray tube current is sometimes influenced by the applied kV. At low kV values, some of the electrons emitted from the cathode which are not attracted to the anode form a space charge.

3.4.3 *Time, seconds,* which is the duration of x-ray exposure. In film radiography, the exposure is initiated by the equipment operator and then terminated after a preset time has elapsed. The x-ray equipment with manual timer requires the operator to set the exposure time before initiating the exposure. The time is determined either by personal knowledge or from a technique chart, considering the size of the patient and selected kV and mA values. The dose delivered (exposure) to the patient is proportional to the product of tube current (mA) and exposure time (s) when other factors are constant. Increasing the exposure does not affect beam quality.

In all the diagnostic centers selected for this study, the operator (Radiographer) controlled the quantity and quality of radiation that penetrated the body of the patient through the selection of exposure parameters listed above. Each of these parameters has its control button on the control panel of the x-ray machine. All the x-ray machines considered in this study have manual timer control.

3.5 *X – RAY BEAM QUALITY AND RADIATION OUTPUT MEASUREMENT*

Radiation beam quality describes the ability of x-ray beam to penetrate medium. The quality of x-ray beam is a function of tube voltage (kV) which in turns determines the filter material type and thickness to be installed in the x-ray tube. Half-value layer (HVL) measurement is required to determine the quality of x-ray beam energy in diagnostic radiology. The measurement of HVL was not carried out in all the centres due to unavailability of the required equipment namely Aluminium filter of various thickness, ionization chamber and electrometer.

Another quality control measurement that is crucial to this study is the radiation output (beam quantity) measurement. The radiation output of an x-ray machine is defined as the absorbed dose in air (mR) per tube current (mAs) at a distance of one metre from the tube focus. The radiation output of an x-ray machine is very important in the calculation of patient exposure in diagnostic radiology (European Commission, 1996). In this study, the radiation output was measured with a non-invasive x-ray test meter model 4000 M+. This meter was manufactured by the Victoreen in the United State of America.

The radiation output of the selected x-ray machine in all the centres were measured by placing the x-ray test device, carefully aligned with the central axis of the beam, at a focus to detector (FDD) distance of 60 cm instead of 100 cm. This was done to reduce the distance between the radiation source and the detector, thereby preventing radiation backscattered.

The radiation exposure (mR) in air at FDD of 60 cm was measured with the test meter and then normalized to exposure in air at FDD of 100 cm through the use of

inverse square law relation ($I \propto 1/d^2$). The radiation exposure in air was measured for five different values of exposure parameters which include combination of tube voltage (kV) and tube loading (mAs). These values were set from the control console, located at about 150 cm away from the x-ray machine. The exposure parameters were set in such a way that the tube loading, commonly employed at the centre, was kept constant while varying the tube voltage (kV).

Thereafter, exposure in air per tube loading (mR/mAs) was calculated and converted to dose per tube current (mGy/mAs) using a conversion factor of 8.73 mGy/R. The values of radiation output as a function of applied voltage was fitted to equation (polynomial of order 4) of the form shown in equation 3.1 below:

$$\text{Radiation _ Output(mGy/ mAs)} = a_4V^4 + a_3V^3 + a_2V^2 + a_1V + a_0 \quad 3.1$$

Where V represents the numerical value of kV and a_0 , a_1 , a_2 , a_3 and a_4 are constants resulting in best-fit to equation (3.1).

3.5.1 **QUALITY CONTROL OF FILM PROCESSOR**

A thorough quality control measurement on film processing system could not be carried out in all the centres. This is due to unavailability of the required equipment namely sensitometer and densitometer. The alternative method of measurement employed in this study was contamination test of the replenisher (developer and fixer) chemistry. This is a comparative test used for all the centers. It was carried out with the use of two pieces of unexposed films in the darkroom. While in the darkroom, one of the films was dipped inside the developer and the other one in the fixer for about 10 seconds. The interaction between unexposed film and either the developer or fixer produces a change in colour of the film. The films were thereafter dried according to the drying procedure of each centre. The uniformity of the colour observed in each of the soaked film was used to estimate the chemical status of the developer and fixer respectively.

Also, the general working conditions of the darkroom in each of the centre was assessed. This was done to check leakages of external light into the darkroom. The presence of leakage light in the darkroom could fog unexposed photographic films

during film loading into the cassette. The fogged film will eventually lower the quality of photographic image.

3.6 DOSE AREA PRODUCT, DAP

The quantity DAP is the product of the cross-sectional area of radiation beam and the average dose delivered to the patient and it is a measure of energy imparted to the patients during medical radiation exposure (George, 2006). It is one of the several indirect methods proposed for practical estimation of effective dose due to the ease with which it can be measured in the x-ray room. It can be measured with a DAP meter attached to the light beam diaphragm housing of the x-ray tube calculated from the knowledge of beam output and cross-sectional area of radiation beam on the patient. The latter method was used in this study due to non-availability of DAP meter.

The DAP was calculated from the measured beam output and exposure parameter chosen for each patient's examination. Literatures (Yakoumakis et al, 2001; Nicholas et al, 2002; and Mcparland., 1998) have shown that DAP is more sensitive to x-ray field than its counterpart quantity, entrance skin dose (ESD), hence its wide application in the computation of organ doses. DAP is one of the major input data used in the program PCXMC, for calculating organs doses and effective dose in diagnostic radiology.

Mathematically, DAP is expressed as:

$$\text{DAP (mGy.cm}^2\text{)} = L \text{ (mAs)} \times X_o \text{ (mGy/mAs)} \times A_{\text{FSD}} \text{ (cm}^2\text{)} \quad (3.2)$$

where L is the tube loading, X_o is the radiation output with respect to applied voltage, FSD is the focus to skin distance and A_{FSD} is the cross-sectional area of the beam on the the skin of patient.

3.7 COMPUTATION OF ORGAN DOSES USING PCXMC SOFTWARE PROGRAM

The Personal Computer X-ray Monte Carlo, PCXMC, is a software program for calculating radiation dose to various organs of patient during medical x-ray examinations. The use of PCXMC program for dose calculation for a given x-ray examination involves three steps namely (1) definition of examination conditions, (2) Monte Carlo simulation, and (3) calculation of organ doses.

Upon issuance of license to use PCXMC 1.5 program, it was installed on a computer hard disk of sufficient storage capacity required to accommodate the graphics included in the program. This was stored in the programs folder of the computer system.

On choosing the PCXMC 1.5 from the programs folder, the main window of the program is displayed on the monitor. This main window comprises of five buttons namely examination data, simulate, compute doses, about and exit. This is shown in figure 3.1.

PCXMC 1.5

Examination data

Simulate

Compute dose

About

Exit

Fig. 3.1 The main form of PCXMC

Clicking of each button activates different subprograms of PCXMC. The function of each button is explained as follows:

- 1) **Examination data:** clicking this button opens a new window shown in fig. 3.2 below. This window allows the user to define the x-ray examination conditions and phantom model which will be used in the Monte Carlo simulation. Some of the information data contained in this window include the following:
 - (i) **Header:** this is shown on the first data row of the window. Here, the user specifies the type of the x-ray examination such as chest, abdomen.
 - (ii) **Patient's data:** this is meant for input demographic data of patient such as age, height and weight.
 - (iii) **Geometric data row:** this is for input geometric data namely, focus to skin distance, beam width, height and coordinates of arbitrary point (X_{ref} , Y_{ref} and Z_{ref}). These coordinates of arbitrary point is located inside the phantom and through it, the central axis of x-ray beam is directed.
 - (iv) **Field size calculator:** the field size calculator calculates the FSD and the width and height of the x-ray beam at the patient's input plane. In order to calculate the FSD, the user input the patient's thickness. The calculated FSD and beam size data are copied to their edit boxes when the user clicks the "use this data" - button.
 - (v) **The 'projAngle' and 'cranio-caudal angle' data row:** this allows the user to specify the direction of the x-ray beam with respect to the phantom.
 - (vi) **The check-box 'Draw x-ray field':** this box is used to control whether the x-ray beam edges should be displayed on the phantom image or not. If the box is clicked, x-ray beam edges would be shown on the phantom image.
 - (vii) **Simulation data row:** this row is meant for input simulation details namely, the maximum quantum energy of interest and the

number of quanta in the simulation. The maximum quantum energy is the energy per 10 keV chosen for simulation and is represented by NElevels. The PCXMC manual recommended the use of maximum value of 15 for NElevels, this means that for this study, NElevels = 15.

- (viii) **Nphotos:** this is another simulation parameter. It is a main factor in determining the statistical precision that would be achieved in the Monte Carlo simulation. Nphotos represents the number of photon histories that would be generated. For Nphotos value, the PCXMC manual recommended a minimum value of 10,000 otherwise; the simulation would result in floating point errors.
- (ix) **Computation time:** the computation of radiation dose to various organs and effective dose for a given of x-ray examination typically takes about 30 seconds.

After supplying the appropriate information, the examination input data are saved by the file name specifies by the user and the PCXMC program automatically add extension “.def” to this file name. Clicking the ‘exit’ button takes the user back to the main form.

DefForm

Exit New form Open form Save form Save form as Print as text

Header text

Phantom: Phantom height Phantom mass

Age

Beam data:

FSD Beam width Beam height Xref Yref Zref Draw X-ray field

 Proj. Angle Cranio-Caudal angle

Simulation:

NE level Nphotos

Field size calculator

FID Image width Image height

Phantom exit – Image distance:

FSD Beam width Beam height

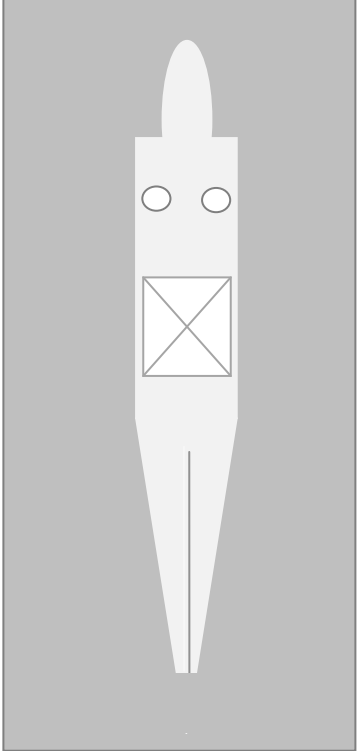

Fig. 3.2 X-ray examination input data form of PCXMC.

- 2) **Simulate:** clicking this button on the main form opens a new window to initiate the actual Monte Carlo simulation shown in figure 3.3 below. Clicking the 'Start' button opens a window that allows the user to choose a definition file (already saved examination data) for simulation. When the 'OK' button is clicked, the simulation starts and the fields of the window show data and progress of the calculation. The calculation is ready when a message window with text 'Done' is displayed. The results of the simulation are stored under the same name as the definition file of the simulation conditions, but the extension '.def' is replaced by '.ene'. This file is then used for calculating the organ doses for any x-ray spectrum specified by the user. The user can then return to the main window by clicking the 'Exit' button.

PCXMC Simulation

Exit

Start

Halt

Age

Skin point

Focus

Energy level Lot No.

Photons in the lot

Fig. 3.3 Monte Carlo simulation window of PCXMC

3) **Compute doses:** Clicking this button on the main form opens a window that is shown in figure 3.4. The data for the presently loaded spectrum (kV, x-ray tube anode angle, filtration) is shown on the window. If this data corresponds to the spectrum that the user wishes to use, the user can proceed directly to calculation of the doses. If the spectrum needs to be changed, the following steps would be taken.

(i) **Update spectrum:** this button is used to input the specific kV selected for x-ray examination under consideration. This window also allows the user to input the tube filtration and x-ray tube anode angle. To get out of this window, the user clicks the button with 'Exit: Generate this spectrum'. The user then proceeds to calculate dose.

(ii) **Calculate dose:** when the button to calculate dose is selected, the user is immediately prompted to select the simulated file name that has been saved with extension 'ene'. When the user double click the file name corresponds to the examination type for which dose calculation is required, the system opens a new window where the user is expected to input any of the following dose quantities namely (i) air kerma at the phantom entrance point in the middle of the x-ray beam (mGy, free in-air), (ii) exposure the phantom entrance point in the middle of the x-ray beam (mR, free in-air), (iii) air kerma-area product (mGy cm^2), (iv) exposure-area product (Rcm^2), or x-ray beam current time product (mAs). In this study, the dose quantity used to calculate organs and effective dose is air kerma area product product (DAP). As the user supplies the DAP corresponding to the x-ray examination, the system calculates organ doses (mGy) and effective doses (mSv) and display them on another window with their estimated precision (error, %). An example of dose calculation window is shown in figure 3.4.

3.8 ESTIMATION OF THE RISK OF CANCER

In this study, the risk of cancer associated with diagnostic x-ray examination is estimated using the nominal probability coefficient for fatal cancer published by the ICRP (ICRP 60, 1990). This probability coefficient was the most generally accepted standard values at the time when the results of this study were collated. The product of probability coefficient of fatal cancer and the values of effective dose to patient that were computed with PCXMC program were used to estimate the number of patient likely to develop cancer in their lifetime following medical x-ray exposure.

The probability that an individual would develop cancer in any of the organs presented in Table 2.1 due to medical x-ray examination was obtained from the ICRP report 60 (ICRP, 1990) and is shown in the relationship below:

$$\text{Risk of Cancer} = R_k H_e \quad (3.3)$$

where H_e is the effective dose (Sv) received by patients during x-ray examination and R_k is the probability coefficients of fatal cancer estimated as $5 \times 10^{-2} \text{ Sv}^{-1}$ (ICRP, 1990; Broerse and Geleijns, 1998). Equation (3.3) is similar to equation (1.3) in the sense that either can be used to assess detriment associated with radiation exposure.

CHAPTER FOUR

RESULTS

4.1 *X-ray Beam Quantity (Radiation Output) Measurements*

The values of exposure per tube loading (mR/mAs) which was measured for different values of kV at different x-ray centres are presented in Table 4.1. The dose per tube loading or otherwise known as tube output (mGy/mAs) which was calculated from the measured exposure per tube loading are presented in Table 4.2 for different kVp at each of the centre selected for this study.

The graphs of beam output along with graphs of fitted data plotted against the tube voltage (kVp) for different centre are shown in figure 4.1. The values of polynomial coefficients a_0, a_1, a_2, a_3, a_4 and regression coefficient (R^2) resulting in the best-fits to equation 3.1 are presented in Table 4.3.

4.2 *Demographic Data for Patients*

The demographic information of 1034 patients selected for this study is presented in Table 4.4. In this table, the values shown in bracket are percentages of the reported quantity over the total number of patients obtained at the respective x-ray centre. The mean ages of patients considered in this study are 27 – 42 years.

4.3 *Area of the body that undergone X-ray Examination*

The number of patient examined for each region of the body and the projection (AP, PA and LAT) of x-ray tube with respect to the examined area of patient at each of the centre are presented in Table 4.5.

Table 4.1: Radiation Exposure per tube loading

X-ray centre	Beam Output (mR/mAs) for various kVp								
	50 kVp	60 kVp	65 kVp	70 kVp	75 kVp	80 kVp	85 kVp	90 kVp	100kVp
UCH (10^{-3})	945	1095	-	1152	-	1281	-	1437	1455
TDC (10^{-4})	-	3066	3186	3372	3534	3984	4410	-	-
OAUTHC (10^{-4})	-	2933	-	3887	-	5313	-	9990	21777
NHA (10^{-3})	306	598	-	918	-	-	1611	-	2246

UNIVERSITY OF IBADAN

Table 4.2: Radiation Dose per tube loading (Beam Output)

	Beam Output (mGy/mAs) for various kVp								
X-ray centre	50 kVp	60 kVp	65 kVp	70 kVp	75 kVp	80 kVp	85 kVp	90 kVp	100kVp
UCH	8.25E-3	9.56E-3	-	1.01E-2	-	1.12E-2	-	1.26E-2	1.27E-2
TDC	-	2.68E-3	2.78E-3	2.94E-3	3.09E-3	3.48E-3	3.85E-3	-	-
OAUTHC	-	2.56E-3	-	3.39E-3	4.64E-3	-	8.72E-3	19.01E-3	-
NHA	2.67E-3	5.22E-3	-	8.02E-3	-	-	14.07E-3	-	19.61E-3

UNIVERSITY OF IBADAN

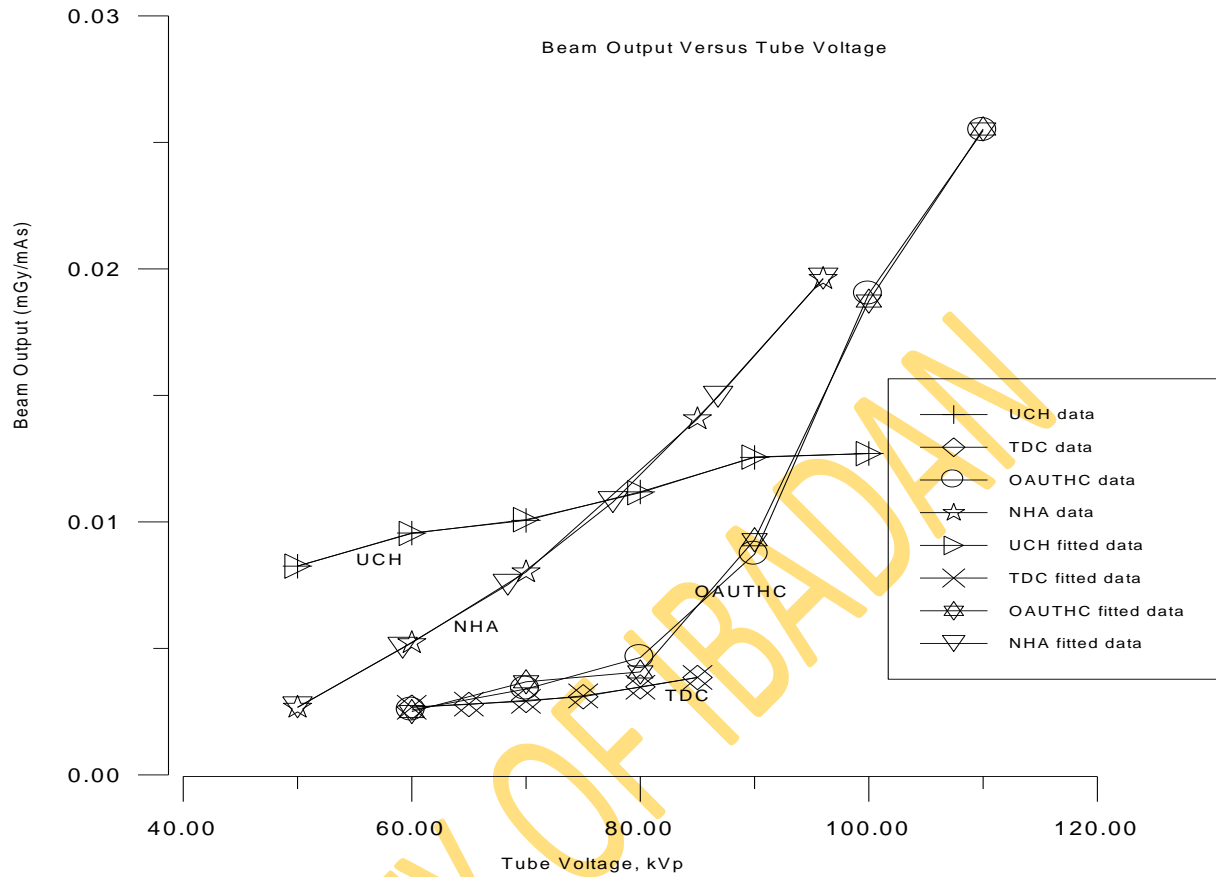

Fig. 4.1 The comparison of values of beam output obtained from centers and those fitted to equation (3.1) for different values of kVp

Table 4.3: Values of a_0 , a_1 , a_2 , a_3 , a_4 and regression coefficient (R^2) resulting in best-fits to equation (3.1) for various centres

<i>Values of polynomial coefficients</i>						
<u>X-ray centre</u>	<u>a_0</u>	<u>a_1</u>	<u>a_2</u>	<u>a_3</u>	<u>a_4</u>	<u>R^2</u>
UCH	-0.1545	0.0092	-19E-04	1.8E-06	-6.0E-09	0.9998
TDC	-0.1763	0.0099	-21E-05	1.9E-06	-6.5E-09	0.9968
OAUTHC	-1.1204	0.0571	-11E-04	8.7E-06	-2.6E-08	0.9982
NHA	-0.0814	0.0046	-9.5E-05	8.9E-07	-3.0E-09	1.0000

Table 4.4a: Demographic information of patients at various centers

<i>Centres considered in this study</i>				
<u>Demographic data</u>	<u>UCH</u>	<u>TDC</u>	<u>OAUTHC</u>	<u>NHA</u>
Sex: Male	173 (56 %)	164 (59%)	130 (59%)	124 (54%)
Female	137 (44%)	112 (41%)	90 (41%)	104 (46%)
Age (yr): Male	35 ± 19	31 ± 17	27 ± 13	27 ± 10
Female	42 ± 17	34 ± 16	27 ± 16	30 ± 14
Weight (kg): Male	57 ± 16	63 ± 11	59 ± 13	63 ± 12
Female	61 ± 15	60 ± 13	54 ± 11	62 ± 17
Height (cm): Male	159 ± 15	164 ± 7	161 ± 12	164 ± 7
Female	162 ± 13	162 ± 8	157 ± 10	162 ± 13
BMI (kg/m²): Male	22 ± 3	23 ± 2	23 ± 2	23 ± 2
Female	23 ± 3	23 ± 2	21 ± 2	23 ± 3

Table 4.4b: Comparison between patient data in this study with previous works by other authors

	<i>No of patient</i>	<i>Age range (yr)</i>	<i>Weight (kg)</i>	<i>Height (cm)</i>	<i>BMI (kg/m²)</i>
<i>This study</i>					
UCH	310	16 – 59	41 – 76	144 – 175	19 - 26
TDC	276	14 – 50	47 – 74	154 - 171	21 - 25
OAUTHC	220	11 – 43	43 – 72	147 – 173	19 - 25
HA	228	16 – 44	45 – 79	149 – 175	20 - 26
<i>Other studies</i>					
Mipem (1998)	867	14 – 92	45 – 82	-	17 – 35
Ogundare (2004)	171	40 – 85	64 - 71	-	-
Ogunseyinde (2002)	75	-	70	-	-
Suliman (2007)	346	16 - 90	37 – 110	-	-
McNeil (1995)	-	47 – 66	-	-	-
Hart (2002)	28,000	16 – 99	32 – 121	-	-
Hart (2009)	23,000	-	65 - 75	-	-

Table 4.5: Type of Radiographic examination and projection per x-ray centre

Type of Radiographic examination and projections						
X-ray centre	Head & Neck (AP, PA & LAT)	Upper Limb (AP & LAT)	Thoracic (AP, PA & LAT)	Abdomen (AP & PA)	Pelvis (AP & LAT)	Lower limb (AP & LAT)
This study						
UCH	95 (26 %)	5 (1 %)	200 (54 %)	4 (1%)	46 (12%)	20 (5%)
TDC	8 (3 %)	5 (2 %)	192 (75 %)	9 (4%)	27 (11%)	16 (6%)
OAUTHC	2 (1 %)	NA	191 (98 %)	NA	NA	2 (1%)
NHA	8 (4 %)	NA	180 (85 %)	3 (1%)	14 (7%)	8 (4%)
Total	113 (11 %)	10 (1 %)	763 (74 %)	16 (2 %)	87 (8 %)	46 (4 %)
Other studies						
Hart (2002)	572 (10%)	-	819 (14%)	2144 (37%)	2220 (39%)	-
Hart (2009)	390 (6%)	-	2960 (48%)	1270 (21%)	1500 (25%)	-
Ogundare (2004)	-	-	-	56 (51%)	53 (49%)	-

The number in bracket, (), is the percentage of the named radiographic examination over the entire x-ray examinations performed at the centre.

4.4 *X-ray Exposure Parameters*

The average values of exposure parameters (kV and mAs), which were selected by the operator for radiographic examinations of different body region at the centres considered in this study are presented in Table 4.6.

4.5 *Application of Anti-scatter grids*

Radiographic examination of most of the regions considered in this study involved the use of anti-scatter grid while some did not. For some regions of the body (head and neck, abdomen and pelvic), the use of anti-scatter grid is required for good image quality while for some regions (thoracic and lower limb) the application of grid does not make much difference. In this study, the mode of application of anti-scatter grid for different x-ray examination is presented in Table 4.7 for each centre.

4.6 *Film Rejection Analysis*

The number of radiographic films which were acceptable and those that were rejected during x-ray examination of different region of the body at each of the centre considered in this study are presented in Table 4.8. In this table, the accepted film is represented by letter "A" while the rejected film is represented by letter "R". Also presented in this table is the percentage of the rejected and accepted films over the whole films used at the centre.

Table 4.6: Average Values of Exposure Parameters (kVp and mAs) used for different Radiographic Examination at various centres

Radiographic examination and its exposure parameters												
<u>X-ray</u>	<u>Head & Neck</u>		<u>Upper Limb</u>		<u>Thoracic</u>		<u>Abdomen</u>		<u>Pelvis</u>		<u>Lower limb</u>	
<u>Centre</u>	<u>kVp</u>	<u>mAs</u>	<u>kVp</u>	<u>mAs</u>	<u>kVp</u>	<u>mAs</u>	<u>kVp</u>	<u>mAs</u>	<u>kVp</u>	<u>mAs</u>	<u>kVp</u>	<u>mAs</u>
This study												
UCH	66	30	59	11	70	49	78	60	82	100	61	19
TDC	78	93	74	57	79	76	80	95	77	94	68	61
OAUTHC	100	128	NA		107	73	NA		NA		92	48
NHA	71	23	NA		73	28	83	40	81	37	66	13
Other studies												
Hart (2002)	72	30	-		86	8	74	46	74	35	-	
Mipem (1998)	70	35	-		80	35	71	57	70	40	-	
Suliman (2007)	67	23	-		66	13	-		74	32	-	
Ogundare (2004)	-		-		-		78	-	79	-	-	

NA: Not Applicable, -: Not available

Table 4.7: Application of grid (Yes or No) during radiological procedure at the centres

<i>Radiological procedure and mode of application of anti-scatter grid</i>						
<u>X-ray Centre</u>	<u>Head & Neck</u>	<u>Upper Limb</u>	<u>Thoracic</u>	<u>Abdomen</u>	<u>Pelvis</u>	<u>Lower limb</u>
UCH	Yes	No	No	Yes	Yes	No
TDC	Yes	No	No	Yes	Yes	No
OAUTHC	Yes	NA	Yes	NA	NA	No
NHA	Yes	NA	No	Yes	Yes	No

NA: Not Applicable

Table 4.8: Rejection Analysis of Radiographic films at the centres

Radiographic examination with the number of accepted film (A) and rejected film (R)														
X- ray	<u>Head & Neck</u>		<u>Upper limb</u>		<u>Thoracic</u>		<u>Abdomen</u>		<u>Pelvis</u>		<u>Lower limb</u>			
Centre	<u>A</u>	<u>R</u>	<u>A</u>	<u>R</u>	<u>A</u>	<u>R</u>	<u>A</u>	<u>R</u>	<u>A</u>	<u>R</u>	<u>A</u>	<u>R</u>	%A	%R
UCH	86	9	5	0	188	12	3	1	39	7	20	0	92	8
TDC	6	2	5	0	189	3	9	0	26	1	11	5	96	4
OAUTHC	2	0	NA		189	2	NA		NA		2	0	99	1
NHA	8	0	NA		176	4	3	0	14	0	8	0	98	2

NA: Not Applicable, R: film rejected, A: film accepted

4.7 *Calculated Dose Area Product (DAP), mGy.cm²*

The dose area product for each x-ray examination of the body region was calculated using equation 3.2. For each of the body region examined at different centre, the values of dose area product obtained are presented in Table 4.9.0.

4.8.0 *Measured Entrance Skin Dose (ESD), mGy*

The values of entrance skin dose (ESD) obtained from the results generated by the PCXMC program for different x-ray examination performed at the centres selected for this study are presented in Table 4.9.1. Also presented in this table are the ESD values obtained from literatures for similar x-ray examinations.

4.8.1 *Calculated organ doses, mGy and Effective dose, mSv*

A typical organ doses and effective dose calculated by the PCXMC program for a patient who undergone chest x-ray examination is presented in Table 4.9.2. The calculated organ doses (mGy) and effective dose (mSv) are displayed on the PCXMC dose calculator window along with their estimated precision. Statistical precision is shown in percentage and the symbol “NA” means not applicable.

The comparison of the values of effective dose received by patients from various x-ray examinations, which were performed at different x-ray centers and those from other studies for similar x-ray examination are presented in Table 4.9.3.

Table 4.9.0: Dose Area Product (mGy.cm²) for various radiographic examinations at various centres

X-ray Centre	Dose Area Product (mGy.cm ²) per x-ray examination					
	<u>Head & Neck</u>	<u>Upper limb</u>	<u>Thoracic</u>	<u>Abdomen</u>	<u>Pelvis</u>	<u>Lower limb</u>
This study						
UCH	122	70	250	451	593	161
TDC	232	94	337	748	324	194
OAUTHC	26341	NA	38155	NA	NA	1939
NHA	152	NA	230	520	310	115
Other studies						
Hart (2009)	-	-	120	3000	3000	-
Edward (2008)	-	-	400	3850	1900	-
Hart (2003)	635	-	110	2600	2100	-
Hart (2002)	-	-	-	-	2100	-
Nicholas (2002)	310	-	170	700	-	-

NA: Not Applicable

Table 4.9.1: Comparison between the Entrance Skin Dose values (mGy) obtained in this study with ESD from published studies.

UNIVERSITY OF IBADAN

Table 4.9.2: Typical organs and effective doses calculated by PCXMC program

Header:	Chest examination	
Projection:	90.0000 (PA)	
Obl. Angle:	0.0000	
Age:	30 years	
Length:	159.8606 cm	
Mass:	56.0000 kg	
Arms in phantom:	1	
FSD:	129.4800 cm	
X-ray beam width:	30.2100 cm	
X-ray beam height	30.2100 cm	
Xfocus:	0.2707	
Yfocus:	138.7380	
Zfocus:	47.1063	
NELevels:	15	
NPhots:	20000	
XYscale:	0.9259	
Zscale:	0.9187	
X-ray tube voltage (kV):	80	
Filter:	0.7 mm Al + 2 mm Al	
SurfDose:	0.1837 mGy	
Organ:	Dose (mGy):	Error (%):
Ovaries	0.000000	NA
Testes	0.000000	NA
Active bone marrow	0.030285	0.4
Skeleton	0.070198	0.5
Lungs	0.099492	1.0
Lower large intestine	0.000184	21.1
Stomach	0.019834	3.8
Liver	0.043877	1.1
Thyroid	0.006650	16.4
Oesophagus	0.039151	5.9
Breasts	0.018855	3.9
Urinary bladder	0.000039	79.8
Skin	0.022672	0.9

Table 4.9.2 contd.

Organ:	Dose (mGy):	Error (%):
Adrenals	0.119021	7.0
Brain	0.000265	14.3
Kidneys	0.044927	2.6
Pancreas	0.042050	4.9
Small intestine	0.001527	7.1
Upper large intestine	0.001792	10.0
Spleen	0.088755	2.5
Thymus	0.013765	11.8
Uterus	0.000552	34.6
Remainder (muscle)	0.020425	0.2
Gall bladder	0.011909	11.7
Heart	0.036837	2.4
Total Body	0.028610	0.1
Effective dose (mSv)	0.027916	1.0
Abs. fraction (%)	69.663918	

UNIVERSITY OF IBADAN

Table 4.9.3: Comparison between the Effective Dose (mGy) obtained in this study with those from similar examinations in published studies.

UNIVERSITY OF IBADAN

4.8.2 *Estimated (per million patients) risk of fatal cancer from different X-ray examinations at the centres considered in this study.*

The results of radiation detriment (broken down into its constituents' organs) associated with different radiographic examination are presented in Table 4.9.4 (a - f) for all the centres considered in this study. The comparison of the risk of fatal cancer estimated from the summation of detriments to various organs at different centers and those from other studies is presented in Table 4.9.5.

4.8.3 *Frequency distribution of some of the quantities considered in this study*

The results of frequency distribution of some of the quantities (such as type of x-ray examinations, age, sex and body mass index (BMI) of patient, exposure parameters, dose area product (DAP), entrance skin dose, effective dose and estimated risk of fatal cancer) considered in this study are summarized in bar charts and shown in figures 4.2 (i – x). The modal value of each quantity obtained at the centres considered in this study is presented in Table 4.9.6.

4.9.0 *X-ray Room layout*

The position of various radiographic accessories with respect to x-ray tube in all the centres considered in this study is presented in Table 4.9.7. The schematic diagram of the layout of x-ray room and the position of various radiographic accessories with respect to x-ray tube/couch at the centers is shown in figure 4.3 (a - d).

Table 4.9.4: Radiation detriment (with respect to various organs) associated with different radiological examination at the centres considered in this study.

a. Head & Neck Examination

b. Upper limb Examination

UNIVERSITY OF IBADAN

c. Thoracic Examination

d. Abdominal Examination

UNIVERSITY OF IBADAN

e. Pelvic Examination per centre

f. Lower limb Examination per centre

UNIVERSITY OF IBADAN

Table 4.9.5: Estimated Risk of fatal cancer associated with different x-ray examinations at various centres

X-ray Centre	Estimated risk of fatal cancer (per million patients)						Sum
	Head & Neck	Upper limb	Thoracic	Abdomen	Pelvic	Lower limb	
This study							
UCH	3 – 4	2 – 3	8 – 9	4 – 5	5 – 6	4 – 5	32
TDC	4 – 5	3 – 4	21 – 22	8 – 9	2 – 3	5 – 6	49
OAUTHC	180 – 200	NA	100 – 400	NA	NA	10 – 15	615
NHA	4 – 5	NA	5 – 6	3 – 4	2 – 3	3 – 4	22
Other studies							
Berrington (2004)							700
Hall (2000)							124
Gabriel (2008)							647

NA: Not Applicable

Table 4.9.6: Modal Ranges of measurable quantities at the centres considered in this study

UNIVERSITY OF IBADAN

Fig 4.2: Bar Charts showing frequency group distribution of x-ray examination, Age, sex, Body Mass Index (BMI) , kV, mAs, Dose Area Product (DAP), Entrance skin Dose (ESD), Effective dose and Risk of cancer at the centres considered for this study

(i) *X-ray Examination group*

UNIVERSITY OF IBADAN

Fig. 4. 2 contd.

(ii) *Age group distribution*

UNIVERSITY OF IBADAN

Fig 4. 2 contd.

(iii) *Sex distribution*

UNIVERSITY OF IBADAN

Fig 4. 2 contd.

(iv) *BMI group distribution*

UNIVERSITY OF IBADAN

Fig 4. 2 contd.

(v) *kV group distribution*

UNIVERSITY OF IBADAN

Fig 4. 2 contd.

(vi) *mAs group distribution*

UNIVERSITY OF IBADAN

Fig 4. 2 contd.

(vii) *DAP group distribution*

UNIVERSITY OF IBADAN

Fig 4. 2 contd.

(viii) Entrance skin Dose group distribution

UNIVERSITY OF IBADAN

Fig 4. 2 contd.

(ix) *Effective dose group distribution*

UNIVERSITY OF IBADAN

Fig 4. 2 contd.

(x) *Estimated Risk group distribution*

UNIVERSITY OF IBADAN

Table 4.9.7: Position of Radiographic Accessories with respect to X-ray tube/couch at the centres

	<i>Area of the Room (cm x cm)</i>	<i>Operator stand (cm)</i>	<i>Lead door (cm)</i>	<i>Changing cubicle (cm)</i>	<i>Chest stand (cm)</i>	<i>Cassette window (cm)</i>	<i>Dark room wall (cm)</i>
Centre							
UCH	400 x 800	180	350	300	174	215	215
TDC	350 x 500	200	205	100	160	135	135
OAUTHC	450 x 600	183	209	180	152	NA	NA
NHA	550 X 600	400	350	367	180	NA	NA

NA: Not Applicable

UNIVERSITY OF IBADAN

UNIVERSITY OF IBADAN

Fig. 4.3a: A schematic diagram of x-ray room at UCH

UNIVERSITY OF IBADAN

Fig. 4.3b: A schematic diagram of x-ray room at TDC

UNIVERSITY OF IBADAN

Fig. 4.3c: A schematic diagram of x-ray room at OAUTHC

UNIVERSITY OF IBADAN

Fig. 4.3d: A schematic diagram of x-ray room at NHA

CHAPTER FIVE

DISCUSSIONS

5.1 *Radiographic Technical Data*

5.1.1 *X-ray Machine*

The energy of x-ray beam (beam quality) is determined by the applied tube kilovoltage (kVp) and the extent to which the beam is filtered (beam hardening). As shown in Table 3.1, most of the x-ray machines considered in this study possessed x-ray tube with aluminium filter except the x-ray machine at the National Hospital, Abuja (NHA) which had combination of aluminium and copper filters. The use of aluminium filter in all the x-ray machines considered in this study is consistent with the practice in the UK (Hart et al. 2002), Malaysia (Mipem et al, 1998), Sudan (Suliman et al, 2006) and in Europe (CEC, 1996). However, different thickness of aluminium filter is recommended for various kVp selections as shown in Table 2.1.

As mentioned in section 2.3 (ii), adequate filtration of radiation beam is meant to eliminate most of the low energy photons from reaching the patient. The amount of aluminium filter (1.7 mmAl) present in the x-ray tube at UCH is within the recommended HVL (Table 2.1) for the range of kVp (59 – 78 kVp) to which the generator operated. Likewise, the filter thickness used at TDC (2.7 mmAl) and NHA (1 mmAl + 0.1 mmCu) were within the recommended HVL for the range of kVp (68 – 80 kVp and 66 – 83 kVp respectively) to which the generator operated. However, the filter thickness used at OAUTHC (1.7 mmAl) was not enough for the range of kVp (92 – 107 kVp) to which the generator operated. From Table 2.1, the recommended range of thickness of aluminium filter that would be appropriate for x-ray tube at OAUTHC is 2.5 – 3.0 mmAl. In the UK national reference dose survey, the range of total filtration in the x-ray tube operated at the tube voltage range of 72 – 141 kVp was 2.5 – 3.0 mmAl.

With respect to the age of x-ray machine, it was observed that x-ray machines in three centres namely, UCH, TDS and OAUTHC, were more than 15 years old at the time of this study (Table 3.1). The x-ray machine at the other centres, namely NHA, was installed after a year of manufactured. Considering the fact that all the centres selected for this study are referral diagnostic centres in Nigeria, they are expected to have up to date x-ray machines. However, from the findings in this study it was not so. Apart from NHA, the x-ray machines used for medical examination of patients in all the other centres have been in clinical use for more than 20 years. The life expectancy of x-ray equipment is about 10 to 15 years (Health Canada, 2011). In a similar study conducted in major and largest diagnostic centres in Sudan (Suliman, 2007), most of their x-ray machines were installed in the year 2003 – 2005 (twentieth century), whereas in this study, all the x-ray machines were installed in the (nineteenth century) year 1974 (UCH); 1998 (TDC); 1981 (OAUTHC); and 1999 (NHA).

5.1.2 *X-ray room design*

The x-ray room that housed the x-ray machine in each of the centre considered in this study was assessed for the purpose of radiation protection within the premises of x-ray unit. A schematic diagram of x-ray room considered in this study is shown in figures 4.3 (a - d). The x-ray room in each of the centre was located at the extreme end of the building of radiology department. This is in accordance with the Atomic Energy Regulatory Board (AERB) safety code for medical diagnostic x-ray equipment and installations. The regulations state that any room housing diagnostic x-ray units and its related equipment shall be located, as far away as feasible, from areas of high occupancy and general traffic (AERB, 2001). In addition to x-ray machine inside the x-ray room, there are other radiographic accessories present within the room. These are x-ray table (couch), operator stand, changing cubicle,

chest stand (support) for chest x-ray examination, leaded entrance door, film cassette and a latch window.

The position of x-ray table with respect to the radiographic accessories mentioned above was measured in each of the centre and is presented in Table 4.9.7. This was done to assess the level of radiation protection of both radiation workers, patients and the general public that could be around the premises during radiation exposure of patient in the x-ray room.

The x-ray tubes in all the centres considered in the study are ceiling suspended type. The position of the couch with respect to x-ray tube is the same in all the centres. The power generator for the x-ray machine is located at the extreme end of the x-ray room in all the centres.

The distance between the x-ray table/couch and the operator's stand (control panel) in each of the centres was 180 cm for UCH; 200 cm for TDC; 183 cm for OAUTHC; and 400 cm for NHA. Although, these distances are large enough to reduce, to a reasonable extent, the radiation intensity before reaching the control panel, they are less than the recommended distance of 300 cm for general purpose fixed x-ray equipment (AERB, 2001). The size of the room that housed the x-ray unit at each centre was commensurate for their clinical activities.

The entrance doors to x-ray rooms in all the centres were lead lined but the equivalent thickness of the lead lining was not measured during this study. This is because the equipment required to measure the thickness of lead in a material was not available during the study. There was only one entrance door to x-ray room at each of the centre and this door was wide enough to accommodate patient's bed and wheel chair as recommended by WHO-Basic Radiology System, BRS (WHO-BRS, 1997). The distance between x-ray tube and leaded entrance door in each of the centre was 350 cm for UCH; 205 cm for TDC; 209 for OAUTHC; and 350 cm for NHA. The variation in these

distances is due to the variation in the entire size of the x-ray room at each centre. With respect to the size of x-ray room in each of the centre selected for this study, these distances, which were measured between the x-ray tube and entrance door in all the centres, are reasonable.

The distance between x-ray tube and changing cubicle, where patient gets dressed and prepared for x-ray examination, in each of the centre was 300 cm for UCH; 100 cm for TDC; 180 cm for OAUTHC; and 367 cm for NHA. These distances, measured in all the centres selected for this study, are enough to protect patients, who may or may not be (as the case in TDC) in the changing cubicle during radiation exposure of another patient, from scattered radiation that could arise from the procedure. The changing cubicle is different from waiting areas, which is located outside the x-ray room at each centre in accordance with medical diagnostic safety code (AERB, 2001).

The distance between x-ray tube and chest stand, which acts as a support for patient during chest x-ray examination in each of the centre was 174 cm for UCH; 160 cm for TDC; 152 cm for OAUTHC; and 180 cm for NHA. The location of the chest stand, with respect to x-ray tube, measured in all the centres was reasonable. This is because no other patient stays at the chest stand while another patient is being examined. Also, the chest stand was positioned in such a way that during chest radiography, the primary beam of radiation was not directed toward the dark room wall. This is in agreement with the safety code recommendations (AERB, 2001).

The distance between the x-ray tube and latched cassette window, through which loaded film cassette is passed from the dark room to x-ray room, in each of the centre was 215 cm for UCH; and 135 cm TDC. The other two centers namely OAUTHC and NHA have their darkroom in a separate room outside the x-ray room. This is because the same darkroom serves other x-ray units within the department. These distances measured at these centres, are reasonable because no one stays near the latched window during radiation exposure.

The distance between x-ray tube and the darkroom wall in each of the centre was 215 cm for UCH; and 135 cm for TDC. These distances measured at these centres, are reasonable because the intensity of radiation that would get to these walls would have been greatly reduced through inverse square law relationship. By reason of these long distances, the dark room workers/ Technicians are protected against scattered radiation.

5.2 *X-ray Beam Output*

The beam output ($\mu\text{Gy}/\text{mAs}$) of x-ray machine presented in Table 4.2 was calculated from the product of exposure per tube loading ($\mu\text{R}/\text{mAs}$) presented in Table 4.1 and conversion factor of 8.77×10^{-3} (Chuang-Jong and Hui-Yu, 1999). From Tables 4.1 and 4.2, it could be seen that the beam output increases gradually with increasing tube voltage (kVp) at constant tube loading. In Sudan where tube output ($\mu\text{Gy mAs}^{-1}$) of various x-ray machines in four major hospitals was measured, a fixed peak tube voltage of 80 kVp and exposure current-time product of 20 mAs were used. The tube output obtained from eight different x-ray machine ranged from 36.8 – 66.1 $\mu\text{Gy mAs}^{-1}$ (Suliman et al, 2007). In this study, the tube output of x-ray machines in all the centres ranged from 2.56 – 19.61 $\mu\text{Gy mAs}^{-1}$. The beam output of x-ray machines considered in this study is about 42 % of the beam output of x-ray machine in Sudan. This variation in beam output could be due to the age of x-ray tubes in most centers considered in this study.

In order to establish the dependence of beam output on tube voltages, the graphs shown in figure 4.1 was plotted for all the centres. The dependence of beam output on tube voltage in all the centres was best-fitted to the polynomial equation of order 4 and the values of the constants were obtained and shown in Table 4.3. The value of regression coefficient (R^2) between the variables (beam output and kVp) in each of the centre was approximately unity, which implies that there was a perfect agreement between the observed data and equation 3.1 for beam output per tube voltage.

5.3 Demographic informationon of patient

Table 4.4 showed that a total of 1034 patients were considered in this study. The number of sample of patient considered in this study is more than those considered in previous studies in Malaysia {867 (Mipem et al, 1998)}; Nigeria {171 (Ogundare et al, 2004) and 375 (Ogunseyinde et al, 2001)}; and Sudan {346 (Suliman et al, 2007)}. In all the centres considered in this study, about 60 % (591) of the patients were males while the remaining 40 % (443) were females. The patients considered in this study were mostly in the reproductive mean age range of 27 – 42 years. At this crucial age range, the optimization of radiation protection is highly recommended for prevention of adverse radiation effects on the unborn generation. The mean age range of patients (27 – 42 years) considered in this study is within the age range used in Malaysia (14 – 86 years; Mipem et al, 1998) and Sudan (16 – 90 years; Suliman et al, 2007). However, the ages of patient considered in this study is younger than those considered in the previous studies in the UK (47 – 66 years; McNeil et al, 1995) and Nigeria (40 – 85 years; Ogundare et al, 2004).

The modal body mass index (BMI), derived from weight / (height)² is a useful classification scheme for the size and shape of a person (Gibson RS, 1990). The mean BMI of patients (21 – 25 kg/m²) considered in this study implies that their weights are commensurate with their heights. This BMI is similar to the mean BMI of study samples (22 – 24 kg/m²) considered in Malaysia (Mipem et al, 1998).

5.4 Area of the body that undergone x-ray examination

As could be seen from Table 4.5, among the x-ray examinations conducted at the centres, the region of the body that has the highest (74%) number of x-ray examinations was thoracic. This was followed by head and neck region (11%); pelvis (8%); lower limb (4%); and upper limb (1%) This trend was similar to the previous study conducted in the UK (Hart et al, 2009)

where the thoracic x-ray examination took the highest frequency (48%) followed by the pelvis (25%), abdomen (21%) and head and neck (6%).

The radiographic projection of x-ray tube with respect to the position of patient during x-ray examination of each of the body region considered in this study includes one or more of the following projections namely Anterior-Posterior (AP), Posterior-Anterior (PA) and Lateral (LAT) views. With the exception of upper and lower limbs, all the x-ray examinations and radiographic views considered in this study are among routine x-ray examinations and projections usually investigated in most studies on patient dosimetry in radiology (Ogundare et al, 2004; Ajayi & Akinwumiju, 2000; Mipem et al, 1998; Hart et al, 2002; Suliman et al, 2006; and Ogunseyinde et al, 2001).

5.5 X-ray Exposure Parameters

X-ray exposure parameters are basic machine settings used for making radiation exposure. They include the applied tube voltage of the beam (kVp), tube current (mA) and time of exposure (sec.). The tube current determines x-ray beam intensity and patient dose. For a given applied kilo voltage, the number of x-ray photons produced is directly proportional to the x-ray tube current.

The exposure parameters (kVp, mA and time) are basic machine parameters that could be used to estimate, with a reasonable degree of accuracy, the dose received by patient during medical x-ray examination. These exposure parameters are usually selected on the control panel of the x-ray machine by the operator before an x-ray exposure could be made. The exposure parameters determine the quantity of x-ray beam that would incident on the skin of patient as earlier mentioned in section 2.3. In order to obtain optimal radiation protection of patient in radiological examination, an operator is expected to combine high kVp with low mAs settings or vice versa. The

selection of high kVp with high mAs for a given x-ray examination usually results in high radiation dose (detriment) to patients.

It could be seen from Table 4.6 that various combinations of kVp and mAs were selected at different centres for the similar x-ray examination. For instance, in the x-ray examination of head and neck region, it was observed that two centres namely, UCH and NHA combined high kV with low mAs. This is similar to the practice in Malaysia (Mipem, 1998); Sudan (Suliman, 2006), and UK (Hart D, 2000), where high kVp was combined with low mAs for x-ray examination of head and neck. However, the two other centres considered in this study namely, TDC and OAUTHC combined high kVp with high mAs.

In this study, it was observed that the x-ray exposure parameters selected at OAUTHC for any type of x-ray examination was always higher than those selected at other centres. This implies that, the patients examined at OAUTHC would receive more dose of radiation than the patients examined at other centres for similar x-ray examination. The factor that could be responsible for the choice of high exposure parameters consistently at OAUTHC is the age (> 23 years) of the x-ray tube. In the x-ray examination of upper limb region, the exposure parameters selected by the two centres that carried out the procedure, namely UCH and TDC, was almost similar in radiation effect due to combination of high kVp with low mAs at both centres. In the case of x-ray examination of the thoracic region, OAUTHC used high kVp with high mAs. Other centres, namely UCH, TDC and NHA used high kVp with low mAs. The technique of using high kVp and low mAs were reported to be commonly used for chest radiography in Europe and the USA (Fung and Gilboy, 2001).

For abdominal examination, two centres namely, UCH and NHA, selected combination of high kVp with low mAs while TDC selected low kVp with high mAs. Within the period of this study, OAUTHC did not have patient for abdominal examination. In the case of x-ray examination of pelvic region,

out of three centres that carried out the examination procedure, two centres namely, UCH and TDC, selected low kVp with high mAs. This is similar to the previous study conducted in the United Kingdom, where a low kVp (95 kVp) was combined with a high mAs (110 mAs) setting for x-ray examination of lumbar spine (Hart et al, 2000). However, the exposure parameters selected at NHA for pelvis examination was a combination of high kVp with low mAs. For the x-ray examination of the lower limb all the centres considered in this study selected high kVp with low mAs. From the various combinations of exposure parameters (kVp and mAs) selected at centres considered in this study, it was observed that selection of mAs value greater than 40 (mAs > 40) was common with centres with aged (≥ 20 years old) x-ray tube such as UCH, TDC and OAUTHC.

5.6 Application of anti-scatter grid

In radiological practice, some radiographic examinations would require the use of anti-scatter grid to improve image quality. Anti-scatter grid is usually inserted between the patient and photographic plate before radiation exposure is made as earlier mentioned in section 2.3.4. The improvement in image quality which resulted from the use of anti-scatter grid is a compensation for the high dose of radiation to patient that is usually associated with the use of grid. The manner in which the centres considered in this study applied grid is shown in Table 4.7. All the centres applied anti-scatter grid for x-ray examinations of the pelvic, head and neck regions. There was no centre that applied anti-scatter grid for x-ray examination of both the upper limb and lower limb regions.

In the case of x-ray examination of the thoracic region, the only centre that applied anti-scatter grid is OAUTHC. Since other centres, namely, UCH, TDC and NHA, did not apply anti-scatter grid for thoracic x-ray examination and yet the images were accepted by the operator, it means sufficient diagnostic information can be obtained from x-ray examination of the thoracic region without application of anti-scatter grid. The acceptance of a processed

radiographic film by the operator implies that the image of the structure under examination possesses the required diagnostic information. Most previous studies on x-ray examinations of the thoracic region (such as chest) published in literatures were performed without the use of anti-scatter grids (Hart et al, 2009; Ogundare et al, 2004; George et al, 2004; Hart et al, 2002; Ogunseyinde et al, 2001; Shrimpton et al, 1999; Wall and Hart, 1997; Mipem et al, 1998).

The use of anti-scatter grid for x-ray examination of both the thoracic and head and neck regions at OAUTHC could be responsible for selection of very high exposure parameters for the examinations of the two regions. The exposure parameters selected at OAUTHC for x-ray examinations of the thoracic (107 kVp and 73 mAs) and head and neck (100 kVp and 128 mAs) regions were higher than those selected at other centres for similar x-ray examinations. The exposure parameters selected for x-ray examination of the thoracic region was 70 kVp and 49 mAs at UCH; 79 kVp and 76 mAs at TDC; and 72 kVp and 28 mAs at NHA. For head and neck examination, the exposure parameters was 66 kVp and 30 mAs at UCH; 78 kVp and 93 mAs at TDC; and 71 kVp and 23 mAs at NHA.

5.7 *Film Rejection Analysis*

One of the main goals of any radiology facility should be to minimize patient exposure. One way of accomplishing this goal is through minimizing the number of repeat exposures performed. By definition, reject films are those radiographs of exposed part of the patient that do not contain enough information required to make diagnosis of the structure under examination.

In medical x-ray examination, the rejection of any radiographic film after radiation exposure of patient simply implies repeat of the same x-ray examination. This action subsequently leads to increase radiation dose to patient. In a radiology department, the analysis of the rate at which radiographic film is rejected is an important aspect of quality assurance programme. The primary aim of film rejection analysis is to promote early

detection of technical faults in either x-ray machine or any of the radiographic accessories such as film processing facility, exposure parameters and others. Also, the evaluation of repeat rate for a facility could also serve as a means of improving patient care, decreasing exposure, and reducing film costs (European Commission, 1996). An increased percentage of rejects/retakes is related to the skills of radiographers and therefore points to areas for extended education and training (Waalder and Hofmann, 2010).

Despite the crucial role that film rejection analysis plays in radiological procedure, most machine operators do not document rejected radiographic films for fear of being queried for incompetence. This could be responsible for poor documentation of rejected film observed in all the centers considered in this study (Table 4.8). Within the period of this study and for all the x-ray examinations performed at the centers considered, the total number of rejected films was 8 % at UCH; 4 % at TDC; 1 % at OAUTHC; and 2 % at NHA. These are lower than the 27.6 % reject rate in conventional radiography reported in the UK (Waalder and Hofmann, 2010). The variation is due to lack of proper documentation of rejected films at the centres considered in this study.

5.8 Dose Area Product, DAP ($mGy\ cm^2$)

The dose area product is one of the major input data used in the program, PCXMC, for computation of organs and effective doses in diagnostic x-ray examination, as earlier mentioned in section 1.4.2. In this study, different values of DAP was obtained at different centres for similar x-ray examination. The DAP obtained from various x-ray examinations considered in this study and those from previous studies in literatures (Hart et al, 2009; Edward et al 2008; Hart et al, 2003; Hart et al 2002; and Nicholas 2002) are presented in Table 4.9.0. The values of DAP obtained in this study were compared with the most recent national reference doses in the UK (Hart D et al, 2009) and are discussed in this section.

As shown in Table 4.9.0 the values of DAP obtained from x-ray examination of head and neck region in all the centres ranged from 122 to 26,341 mGy cm². The highest value (26,341 mGy cm²) of DAP was obtained at OAUTHC while the lowest value (122 mGy cm²) was obtained at NHA. This higher value obtained at OAUTHC could be traced to high exposure parameters (100 kVp and 128 mAs) selected at the centre as compared with the parameters (71 kVp and 23 mAs) selected at NHA. The DAP per radiograph for x-ray examination of the skull (AP, PA, LAT) was not reported in the UK reference dose data. Therefore, the DAP obtained from x-ray examination of the head and neck region in this study could not be compared with UK reference dose data.

From x-ray examination of upper limb, DAP ranged from 70 to 94 mGy cm². The highest value (94 mGy cm²) was obtained at TDC while the lowest value (70 mGy cm²) was obtained at UCH. The high value of DAP obtained at TDC is traceable to exposure parameters (74 kVp and 57 mAs) selected at the centre as compared with parameters (59 kVp and 11 mAs) selected at UCH. As is the case with x-ray examination of head and neck region, DAP per radiograph of upper limb examination was not reported in the UK reference dose data.

From x-ray examination of thoracic region, the values of DAP ranged from 230 to 38,155 mGy cm². The highest value (38,155 mGy cm²) was obtained at OAUTHC while the lowest value (230 mGy cm²) was obtained at NHA. The DAP obtained at OAUTHC was very high compared to DAP obtained at other centres. This high value of DAP is traceable to high exposure parameters (107 kVp and 73 mAs) selected at the centre as compared with the parameters (73 kVp and 28 mAs) selected at NHA and other two centres, namely UCH (70 kVp and 49 mAs) and TDC (79 kVp and 76 mAs). When compared with the UK reference DAP per radiograph (120 mGy cm²) for similar x-ray examination but lower exposure parameters (86 kVp and 8 mAs), the DAP values obtained in this study and especially at OAUTHC were very high.

However, the UK reference DAP value was reported for PA chest examination alone whereas, the DAP value recorded for thoracic x-ray examination in this study was averaged over three projections of chest (PA, AP and LAT) and two projections of thoracic spine (AP, LAT). The thoracic region in this study comprises of chest and thoracic spine.

From x-ray examination of abdominal region, the values of DAP ranged from 451 to 748 mGy cm². The highest value (748 mGy cm²) was obtained at TDC while the lowest value (451 mGy cm²) was obtained at UCH. The highest value of DAP obtained at TDC is traceable to high exposure parameters (80 kVp and 95 mAs) selected at the centre as compared with the parameters selected at UCH (78 kVp and 60 mAs) and NHA (83 kVp and 40). However, the DAP obtained from all the centres was smaller than the UK reference (3000 mGy cm²) DAP per radiograph for AP abdomen using average exposure parameters 74 kVp and 46 mAs (Hart et al, 2002).

From x-ray examination of pelvic region, the values of DAP ranged from 310 to 593 mGy cm². The highest value (593 mGy cm²) of DAP was obtained at UCH while the lowest value (310 mGy cm²) was obtained at NHA. The higher DAP obtained at UCH is traceable to high exposure parameters (82 kVp and 100 mAs) selected at the centre as compared with those selected at other centres namely, TDC (77 kVp and 94 mAs) and NHA (81 kVp and 37 mAs). Again, the DAP obtained in this study for pelvis (AP and PA) examination in all the centres was smaller than the UK reference (3000 mGy cm²) DAP per radiograph for AP pelvis using average exposure parameters 74 kVp and 35 mAs (Hart et al, 2002).

From x-ray examination of lower limb region, the values of DAP ranged from 115 to 1939 mGy cm². The highest value (1939 mGy cm²) was obtained at OAUTHC while the lowest value (115 mGy cm²) was obtained at NHA. The high value of DAP obtained at OAUTHC is traceable to high exposure parameters (92 kVp and 48 mAs) selected at the centre as compared with the parameters selected at other centres namely, UCH (61 kVp and 19 mAs), TDC

(68 kVp and 61 mAs) and NHA (66 kVp and 13 mAs). The DAP per radiograph for lower limb was not reported in the UK reference dose data, therefore the DAP obtained for lower limb in this study was compared among centers only.

5.9 *Entrance Skin Dose (ESD), mGy*

The entrance skin dose (ESD) is a measure of radiation dose at the skin of the patient. It is directly proportional to DAP values, which means that the higher the values of DAP, the higher would be the values of ESD.

In this study, all the x-ray examinations that gave rise to high values of DAP also resulted in high entrance skin dose to patients and as presented in Table 4.9.1. The entrance skin dose obtained from x-ray examination of head and neck region ranged from 0.383 to 9.180 mGy. The highest value of ESD (9.180 mGy) was obtained from OAUTHC, the same centre that had highest value of DAP from x-ray examination of head and neck region. The ESD for other centres namely, UCH TDC and NHA are 0.383 mGy, 0.687 mGy and 0.666 mGy respectively. With the exception of values of ESD obtained at OAUTHC, the values of ESD obtained at UCH, TDC and NHA for x-ray examination of head and neck region were within the range of ESD values obtained for similar x-ray examination from previous studies presented in Table 4.9.

The values of ESD obtained from x-ray examination of upper limb region ranged from 0.296 to 0.434 mGy. The highest ESD (0.434 mGy) was obtained from TDC, the same centre that had the highest value of DAP from x-ray examination of upper limb region. The ESD for the other centre namely, UCH is 0.296 mGy. These (TDC and UCH) were the only centres that performed x-ray examination of the lower limb during this study.

The values of ESD obtained from x-ray examination of thoracic region (chest and thoracic spine) ranged from 0.410 to 3.730 mGy. The highest ESD (3.730 mGy) was obtained at OAUTHC, the same centre that had the highest

value of DAP from x-ray examination of thoracic region. The ESD from other centres namely, UCH TDC and NHA are 0.468 mGy, 1.606 mGy and 0.410 mGy respectively. These values except the value at OAUTHC are within ESD values obtained from other studies in presented in Table 4.9.1. The highest ESD value obtained at OAUTHC (3.730 mGy) could be linked to the use of anti-scatter grid for thoracic x-ray examination at the centre. In the UK, where the use of anti-scatter grid for x-ray examination is a standard, chest x-ray examination was performed without application of grid. However, anti-scatter grid was applied in x-ray examination of the thoracic spine. The use of anti scatter grid for x-ray examination of the thoracic spine in the UK could be responsible for the high ESD reported (3.50 – 10.00 mGy) as compared to the values (0.20 – 1.00 mGy) reported for chest x-ray examination in the UK reference dose (Hart et al, 2002).

The values of ESD obtained from x-ray examination of abdominal region in this study ranged from 0.585 to 1.199 mGy. The highest ESD (1.199 mGy) was obtained from TDC, the same centre that had the highest value of DAP from x-ray examination of abdominal region. The ESD for other centres namely, UCH and NHA are 0.585 mGy and 0.697 mGy respectively. The values of ESD obtained at UCH, TDC and NHA for x-ray examination of abdominal region were within the range of values obtained from previous studies presented in Table 4.9.1.

The values of ESD obtained from x-ray examination of pelvic region ranged from 0.849 – 2.577 mGy. The highest ESD (2.577 mGy) was obtained from UCH, the same centre that had the highest value of DAP from x-ray examination of pelvic region. The ESD for other centres namely, TDC and NHA are 0.849 mGy and 1.267 mGy respectively. The values of ESD obtained at UCH, TDC and NHA for x-ray examination of pelvic region were within the range of values obtained from x-ray examination of the pelvis from previous studies presented in Table 4.9.1.

The values of ESD obtained from x-ray examination of lower limb region ranged from (0.273 – 7.970) mGy. The highest ESD (7.970 mGy) was obtained from OAUTHC, the same centre that had the highest value of DAP from x-ray examination of lower limb region. The ESD for other centres namely, UCH TDC and NHA are 0.571 mGy, 0.969 mGy and 0.273 mGy respectively.

5.10 *Radiation doses and effective dose (mSv) in various organs of patients*

The program, PCXMC, made use of equation (1.2) to calculate the effective dose. Typical organs and effective doses calculated by PCXMC program for a patient who undergone chest x-ray examination is presented in Table 4.9.2. Other items in the table are demographic data of patient, exposure parameters selected for the examination, generated organ and effective doses. The effective dose, as mentioned in section 1.4.3, is the quantity of choice for estimating detriment associated with radiation exposure.

As could be seen from Table 4.9.3, the effective dose received by patients during radiation exposure was found to vary from one x-ray examination to another. The range of effective dose received by patients from x-ray examination of the head and neck region was between 0.01 and 2.16 mSv. The highest value of effective dose was obtained at OAUTHC. However, the mean effective dose (2.16 mSv) obtained at OAUTHC is less than the median effective dose (3.89 mSv) obtained from x-ray examination of the skull in a study conducted in Malaysia (Mipem et al, 1998). The effective dose from head and neck region obtained from other centres, namely UCH (0.01 mSv), TDC (0.04 mSv) and NHA (0.01) were consistent with those obtained from similar studies reported in literatures by previous authors namely, Wall (0.02 mSv; Wall et al, 1997); David and Walter (0.10 mSv; David and Walter, 2008); Shrimpton (0.03 mSv; Shrimpton et al, 1999) and IAEA (0.07 mSv; IAEA, 1996).

The range of effective dose received by patients from x-ray examination of the upper limb region was between 0.01 and 0.07 mSv. The highest value of effective dose (0.07 mSv) was obtained at TDC. In all the literatures reported in this section, none of them reported effective dose from x-ray examination of both the upper and lower limb regions.

The range of effective dose received by patients from x-ray examination of the thoracic region was between 0.01 and 4.74 mSv. The highest effective dose value of 4.74 mSv was obtained at OAUTHC. The value of effective dose obtained at OAUTHC is higher than those obtained from similar x-ray examination reported in literatures by authors namely, Wall (0.40 mSv; Wall et al, 1997); Mipem (0.72 mSv; Mipem et al, 1998); David (0.05 mSv; David et al, 2008); Shrimpton (0.35 mSv; Shrimpton et al, 1999) and IAEA (0.39 mSv; IAEA, 1996). The highest effective dose obtained at OAUTHC from chest x-ray examination was due to radiographic technique (the use of anti scatter grid) employed at the centre.

The range of effective dose received by patient from x-ray examination of the abdominal region was between 0.35 and 1.10 mSv. The highest (1.10 mSv) effective dose was obtained at TDC. The range of effective dose obtained from x-ray examination of the abdomen in this study was more than those reported (0.16 – 0.51 mSv) in the previous study in Nigeria (Ogundare et al, 2004). This variation in effective dose is partly due to the radiographic techniques and method of dose measurement used. While Ogundare et al, 2004 reported a mean exposure parameters of 78 kVp (mAs not reported) for x-ray examination of abdomen, a mean exposure parameters of 80 kVp and 65 mAs were used in this study. Also, Ogundare et al, 2004 used thermoluminescence dosimetry method to measure the dose to patient whereas, in this study Monte Carlo program, PCXMC, was used. Although variation in method used is not expected to introduce a major difference. In this study, the highest effective dose (1.10 mSv) obtained from abdominal x-ray examination was found to be small when compared with those reported by various

authors namely, Schandorf (1.71 mSv; Schandorf et al, 1998) and Mipem (9.22 mSv; Mipem et al, 1998).

The range of effective dose received by patient from x-ray examination of pelvic region was between 0.54 and 0.61 mSv. The highest value of effective dose (0.61 mSv) was obtained at UCH. This high value of effective dose obtained at UCH is less than those obtained from similar study reported in literatures namely, Schandorf (1.71 mSv; Schandorf et al, 1998); Muhogora and Nyanda (0.62 mSv; Muhogora and Nyanda, 2001); Wall (0.70 mSv; Wall BF et al, 1997); Mipem (5.33 mSv; Mipem et al, 1998) and Shrimpton (0.66 mSv; Shrimpton et al, 1999).

The range of effective dose received by patient from x-ray examination of lower limb region was between 0.01 and 0.04 mSv. The highest value of effective dose (0.04 mSv) was obtained at OAUTHC. The effective dose for lower limb was not reported by previous authors considered in this section.

5.11 *Estimated Risk of cancer from diagnostic x-ray examinations.*

One of the principles of radiation protection earlier mentioned in section 1.6 is justification. Justification in relation to radiation exposure means that before any radiation exposure is made, the derived benefit outweighs the associated detriment. The detriment considered in this study is cancer induction. The summation of detriment in different organs of exposed patient gave the total harm associated with x-ray examination of that body region. These are presented in Table 4.9.4 (a – f) for x-ray examination of various region of the body.

The risk of fatal cancer estimated in each of the centre selected for this study, with the assumption that one million patients undergone x-ray examinations, are presented in Table 4.9.5. Also presented in this table is the summation of risk of cancer (such as thyroid cancer and cataracts) incidence observed in previous studies of patients/radiation workers who were exposed to ionizing radiation and

published by authors namely, Hall et al, 2000; Berrington et al, 2004; and Gabriel et al, 2008. The number of patient who developed cancer from radiation exposure reported by these authors ranged from 124 to 700 in a population less than one million. The International Commission on Radiation Protection, ICRP, has recommended that if one million patients receive a whole body irradiation of 1 Sv, the number of patient likely to develop cancer in their lifetime should not exceed 35. This is represented as 35×10^{-6} (ICRP 60, 1990; UNSCEAR, 2000; and Berrington de Gonzalez A, 2004).

The risk of fatal cancer estimated from x-ray examination of the head and neck region at each of the centre considered in this study was 4×10^{-6} for UCH; 5×10^{-6} for TDC; 200×10^{-6} for OAUTHC and 5×10^{-6} for NHA. The number of patients who are likely to develop cancer from head & neck examination was higher at OAUTHC than those from other centers considered in this study. The risk of fatal cancer estimated at OAUTHC was higher than the ICRP recommended limit.

The risk of fatal cancer estimated from x-ray examination of the upper limb region at each of the centre considered in this study was 3×10^{-6} for UCH and 4×10^{-6} for TDC. The number of patients who are likely to develop cancer from this procedure was almost equal at both centres and is within the ICRP recommended limit.

The risk of fatal cancer estimated from x-ray examination of the thoracic region at each of the centre considered in this study was 9×10^{-6} for UCH; 22×10^{-6} for TDC; 400×10^{-6} for OAUTHC and 6×10^{-6} for NHA. The number of patients who are likely to develop cancer from thoracic x-ray examination at OAUTHC is higher than the recommended limit.

The risk of fatal cancer estimated from x-ray examination of abdominal region at each of the centre selected for this study was 5×10^{-6} for UCH; 9×10^{-6} for TDC

and 4×10^{-6} for NHA. The number of patients who are likely to develop cancer from abdominal examination at these centres is within the recommended limit of 35×10^{-6} .

The risk of fatal cancer estimated from x-ray examination of pelvic region at each of the centre selected for this study was 6×10^{-6} for UCH; 3×10^{-6} for TDC and 3×10^{-6} for NHA. The number of patients who are likely to develop cancer from pelvis examination in all these centres is within the recommended limit of 35×10^{-6} .

The risk of fatal cancer estimated from x-ray examination of lower limb region at each of the centre selected for this study was 5×10^{-6} for UCH; 6×10^{-6} for TDC; 15×10^{-6} for OAUTHC and 4×10^{-6} for NHA. Although, the number of patients who are likely to develop cancer from this procedure was higher at OAUTHC than those from other centers yet, the risk in all the centres still falls within the recommended limit.

With the exception of x-ray examination of the lower limb region, the number of patient who is likely to develop cancer in their lifetime, which was obtained at OAUTHC, was consistently higher than the recommended value of 35×10^{-6} . This is due to consistent selection of high exposure factors (mAs & KVp) for most of the x-ray examination performed at the centre.

5.12. *Frequency distribution of measured variables*

The frequency distribution of variables measured at the centres considered in this study is presented in Table 4.9.6. In all the centers, x-ray examination of the thoracic region has the highest frequency distribution. The modal age range of patients selected at UCH was between 42 and 50 years while the patients selected at other centres namely TDC, OAUTHC and NHA have the same modal age range between 21 and 30 years. The number of male patients in each of the centre was

more than their female counterparts. The most frequent range of body mass index (BMI) of patients in each of the centre selected for this study was the same. This BMI was between 21 and 25 kg/m².

The most frequent range of kVp selected during x-ray examinations performed in each of the centres selected for this study are 56 - 60 for UCH; 76 - 80 for TDC; 105- 110 for OAUTHC; and 66 - 70 for NHA. Similarly, the most selected mAs in each of the centre are 9 – 34 for UCH; 35 - 50 for TDC; 76 - 100 for OAUTHC; and 66 - 70 for NHA. The most frequent DAP obtained from x-ray examination in each centre are 0 – 100 mGy cm² for UCH; 101 – 200 mGy cm² for TDC; 30,001 – 40, 000 mGy cm² for OAUTHC and 101 - 200 mGy cm² for NHA.

The most frequent range of ESD obtained from x-ray examination performed in each of the centre selected for this study are 0.05 – 0.50 mGy for UCH; 0.05 – 0.50 mGy for TDC; 3.10 – 3.50 mGy for OAUTHC; and 0.05 – 0.50 mGy for NHA. Only OAUTHC has ESD range of values that differ from other three centres. Likewise, the most frequent effective dose range in three centres namely UCH (0.01 – 0.05 mSv); TDC (0.01 – 0.05 mSv); and NHA (0.01 - 0.05 mSv) are the same, while that of OAUTHC (2.60 – 3.00 mSv) differs from other centres.

The most frequent risk of cancer estimated in each of the centre selected for this study are between 1×10^{-6} and 10×10^{-6} for UCH; 11×10^{-6} and 20×10^{-6} for TDC; 151×10^{-6} – 200×10^{-6} for OAUTHC; and 1×10^{-6} – 10×10^{-6} for NHA. The most frequent cancer risk estimated at UCH and NHA are similar and acceptable. Likewise, the values obtained at TDC are acceptable but the values obtained at OAUTHC are not acceptable when compared with the ICRP recommended value. However, the risk of thyroid cancer in patient receiving diagnostic amount of I-131 was estimated in the UK and was found to be 124 out of 36,443 patients (Hall et al, 2000).

In another study conducted in the UK, where risk of cancer from diagnostic x-ray was estimated for the UK and 14 other developed countries, it was found that the cumulative risk of cancer cases is about 0.6 %. This risk value (0.6 %) was reported to be equivalent to 700 cases of cancer per year among UK population (Berrington et al, 2004). The estimated risk of cancer reported for the remaining 13 developed countries considered by Berrington et al, 2004, was between 0.6 % and 1.8 %. The highest risk of 3 % was obtained in Japan (Berrington et al, 2004).

UNIVERSITY OF IBADAN

CHAPTER SIX

CONCLUSION AND RECOMMENDATION

6.1 *Conclusion*

The detrimental health effects of radiation associated with diagnostic x-ray examinations have been estimated at four diagnostic centres in Nigeria. These centres namely, the University College Hospital (UCH), Ibadan; TwoTees Diagnostic Centre (TDC); Obafemi Awolowo Teaching Hospital Complex (OAUTHC) Ile-Ife; and National Hospital Abuja (NHA). The method used to estimate the detriment was in two parts. The first part dealt with the calculation of effective dose received by patient during x-ray examination using Monte Carlo computer program, PCXMC, while the second part used the calculated effective dose to determine risk of fatal cancer.

The number of internal organs of the body to be considered for the calculation of effective dose is about 22. Therefore, the use of other methods such as those mentioned in section 2.7, apart from Monte Carlo computer program such as PCXMC, to calculate effective dose in routine x-ray examinations would be cumbersome (Yakoumakis et al, 2001). The use of PCXMC in this study has proved to be very useful and less cumbersome.

From the results obtained in this work, the following conclusions are made:

1. Lack of regulatory body (such as the Nigerian Nuclear Regulatory Authority, NNRA) in Nigeria before the year 2001 gave room for importation of out dated x-ray machine into the country. Most of these x-ray machines had aged x-ray tube that made them unsuitable for medical x-ray examination.
2. This study has shown that 75 % of x-ray machines in Nigeria were installed after about 10 years of manufacture. In addition to this, the thickness of

filter material in most of the x-ray tubes are not adequate for the tube voltage (workload) to which the x-ray machine are subjected.

3. In all the x-ray examination considered in this study namely, thoracic, head and neck, pelvic, lower limb, abdomen and upper limb regions, the examination of highest frequency in all the centres was thoracic (74%). This was followed by head and neck (11%); pelvic (8%); lower limb (4%); abdomen (2%); and upper limb (1%).
4. The total number of patient selected randomly from all the centres, for this study, was 1034. This includes 310 for UCH, 276 for TDC, 220 for OAUTHC and 228 for NHA. The mean age (years) of patients examined at UCH, TDC, OAUTHC and NHA was 38 ± 1 , 32 ± 1 , 27 ± 1 , and 38 ± 1 respectively.
5. The exposure parameters (kVp and mAs) selected for a given x-ray examination varies from centre to centre. The mean exposure parameters, (kVp and mAs) selected are 69 and 45 at UCH, 76 and 79 at TDC, 100 and 83 at OAUTHC and 75 and 28 at NHA.
6. The mode of application of anti-scatter grid is the same in all the centres for different type of x-ray examinations except at OAUTHC, where grid was applied for thoracic x-ray examination. The use of anti-scatter grid for any type of x-ray examination at OAUTHC was found to be the main cause of selection of high exposure parameters recorded at the centre. For instance, the exposure parameters selected for head and neck (100 kVp and 128 mAs); and thoracic x-ray examinations (107 kVp and 73 mAs) were higher those selected at other centres for similar x-ray examinations.
7. The dose area product, DAP (mGycm^2) obtained from all the regions of the body examined are between 70 and 593 mGycm^2 at UCH, 94 and 748 mGycm^2 at TDC, 1939 and 38155 mGycm^2 at OAUTHC and 115 – 520 mGycm^2 at NHA.
8. This study has shown that the entrance skin dose (mGy) from all the examinations are between 0.3 and 2.6 mGy at UCH, 0.4 and 1.6 mGy at TDC, 3.5 and 9.2 mGy at OAUTHC and 0.4 and 1.3 mGy at NHA.

Similarly, the effective dose (mSv) are between 0.01 and 0.61 mSv at UCH, 0.01 and 1.10 mSv at TDC, 0.24 and 4.74 mSv at OAUTHC and 0.01 and 0.60 mSv at NHA. When these effective doses were compared with effective doses obtained from similar studies that have been reported in literatures, it was found that the effective doses obtained in this study were within their range of values.

9. The risk of cancer (per million patients) estimated from all the medical x-ray examinations performed at each of the centres considered in this study ranged from 2 – 9 for UCH, 2 – 22 for TDC, 15 – 400 for OAUTHC and 2 – 6 for NHA.
10. The overall analysis of technical parameters of x-ray machine in all the centres considered in this study showed that the filtration (< 2.5 mmAl) of the tube at OAUTHC is inadequate for the range of tube voltage (> 70 kVp) to which the x-ray machine was subjected
11. The selection of high exposure parameters (high kVp with high mAs) and application of anti-scatter grid for procedure such as thoracic examination, which was performed at other centers (UCH, TDC and NHA) without application of anti-scatter grid, were the main cause of high risk obtained at OAUTHC.
12. The results obtained from this study could serve as an update to existing data on radiation dose to patients from diagnostic x-ray examinations in Nigeria. Also, the findings of this study could be used to assess the detrimental health effect (such as fatal cancer) of radiation associated with diagnostic x-ray examination of different regions of the body.

6.2 *Recommendations*

In order to keep the detrimental health effects of radiation associated with diagnostic x-ray examinations to the bearest minimum, our recommendations are as follows:

1. The age, from the date of manufacture, of any type of x-ray machines used for medical x-ray examinations of patients should not exceed 5 years before installation. In addition to this, the clinical application of such x-ray machines should not exceed the expected useful life of 10 to 15 years.
2. All diagnostic x-ray examinations of patients should be performed with optimized exposure factors. This involves selection of high kV with low mAs and anti-scatter grid should be applied for selective procedures.
3. Also, the filtration (filter type and thickness) of x-ray tube for clinical x-ray examination should be commensurate with the workload (kVp) of the x-ray at the centre.

REFERENCES

Atherton J.V. and W. Huda (1996). Energy imparted and effective dose in Computed Tomography. *Med. Phys.* 23: 735-741.

Atomic Energy Regulatory Board (AERB) (2001). AERB Safety Code for Medical Diagnostic X-ary Equipment and Installations. AERB/SC/MED-2 Mumbai 400 094.

Ajayi I. R. and Akinwumiju A. (2000). Measurement of Entrance surface Dose to Patients in Four Common Diagnostic Examinations by Thermoluminescence Dosimetry in Nigeria. *Radiat. Prot. Dosim* 87 (3): 217 – 220.

Baldelli, P. Taibi, A., Tuffanelli, A., & Gambaccini, M. (2004). Dose comparison between conventional and quasi-monochromatic systems for diagnostic radiology”. *Phys Med Biol.* 7; 49 (17):4135-46.

Berrington de Gonzalez A and Darby S (2004). Risk of cancer from diagnostic X-rays: estimates for the UK and 14 other countries. *Lancet* 363: 345–351.

BEIR V: Committee on the biological effects of Ionising Radiation, National Research Council (1990). Health effects of exposure to low levels of ionizing radiation”. BEIR V.

Bobby R. Scott (2006). Radiation Sources and effects in people. Retrieved on 8 December 2010 from <http://www.radiation.scott.org/radsources/index.htm>.

Bor, D., Sancak, T., Olgar, T., Elcim, Y., Adanali, A., et al. (2004). Comparison of effective doses obtained from dose–area product and air kerma measurements in interventional radiology. *British Journal of Radiology* 77, 315-322.

Boyle P. (2006). The globalisation of cancer. *Lancet* 368 (9536): 629 – 630.

Boyle P. (2008). *World Cancer Report*. Lyon: International Agency for Research on Cancer.

Broerse J. J. and J. Geleijns (1998). The relevance of different quantities for risk estimation in diagnostic radiology. *Rad. Prot. Dosim.* 80 (1-3): 33-37.

Bruce Busby (2006). *The radiation information networks: Radiation and Risk*. Retrieved 4 December 2006 from <http://www.physics.isu.edu/radinf/risk.htm>

Commission of the European Commission, CEC (1990). *Quality Criteria for Diagnostic Radiographic Images*. Working document CEC X11/173/90. 2nd edition (Commission of the European Communities, Bruxelles).

Commission of European Communities publication (1996). *European Guidelines on quality Criteria for Diagnostic Radiographic Images*. EUR 16260 ISBN 92-827-7284-5, Brussels.

Centre for Diseases Control and Prevention (CDC) (2005). *Radiation Emergencies: Acute Radiation Syndrome*. Retrieved 29 April 2010 from <http://www.bt.cdc.gov/radiation/pdf/ars.pdf>

Chan-Hyeong Kim, Sang Hyun Cho and X. George Xu (2005). PRDC- A software package for personnel radiation dose calculation. *Radiation Protection Dosimetry* 1- 8.

Chuan-Jong T. and Hui-Yu T. (1999). Evaluation of gonad dose and fetal doses for diagnostic radiology. *Proc. Natl. Sci. Council ROC B* 23(3): 107 – 113.

Colin, M., Zenon, S., Christine, K. (2005). Burden of disease from radiation Exposure. Radiation Protection Division, Health Protection Agency, Chilton, Didcot, Oxon. Retrieved 12 December 2006 from http://www.hpa.org.uk/ouublications/2005/burden_disease/5supporting_doc.pdf

Cynthia H. McCollough and Beth A. Schueler (2000). Education Treatise: Calculation of effective dose. *Med. Phys.* 27 (5): 828-837.

David Brenner and Walter Huda (2008). Effective dose: A useful concept in diagnostic radiology. *Rad. Protec. Dosim.* 128 (4): 503-508.

Edward L. N., Zheng F. L., Ajoy K. D. and James C. (2008). Radiation dose descriptors; BERT, COD, DAP and other strange creatures. *Radiographics* 28: 1439 – 1450.

European Community Council Directive 97/43 Euratom (1997). Health protection of individuals against danger of ionizing radiation in relation to medical exposure. *Off. Journal L180*:22-27.

Fontham E. T. (2009). Infectious diseases and global cancer control. *CA Cancer Journal Clin.* 59 (1): 5 – 7.

Fung, K. K. L. and Gilboy W. B. (2001). The effect of beam tube potential variation on gonad dose to patients during chest radiography investigated using high sensitivity LiF:Mg, Cu, P thermoluminescent dosimeters. *Br. J. Radiol.* 74: 358 – 367.

Gabriel C., Nural B., Michael H., Bruce H.A., Michael D. F., Michele M. D. et al (2008). Risk of cataract after exposure to low doses of ionizing radiation: A 20-year prospective cohort study among US Radiologic Technologists. *Am. Jour of epidemiology* 168 (6): 620 – 631.

George, I. G., Emmanuel, N. Y., Despina, I. P., Triantafillia, K. M., Nikolaos E. Y. et al (2006). Differences in effective dose and energy imparted estimation from PA–AP, RLAT–LLAT projections in pediatric full spine x-ray examination using the Monte Carlo technique. *Phys. Med. Biol.* 51:287-297.

Gibson R. S. (1990). *Principles of nutritional assessment*. New York: Oxford University Press: 178 – 82.

Gofman (1994). *The health effects of radiation: there is no safe threshold*. University of California San Francisco publication 16 , vol. 38.

Hall, E. J. (1994). Hereditary effects of radiation. In: Hall E.J., edition. of *Radiobiology for the Radiologist*. Philadelphia, Pa: JB Lippincott Co.

Hall, P. (2000). Cancer risks after exposure to low doses of ionizing radiation- contribution and lessons learnt from epidemiology. *Proceedings of a scientific seminar held in Luxembourg*. Invited paper 2:20.

Hart, D., Jones, D. G., & Wall, B. F. (1994). Normalised organ dose for medical x-ray examinations calculated using Monte Carlo techniques. NRPB-SR262. Health protection Agency, Chilton.

Hart, D., Jones, D.G. and Wall, B.F.(1994). Estimation of effective dose in diagnostic radiology from entrance surface dose and dose-area product measurements. NRPB-R262 (Chilton: National Radiological Protection Board).

Hart D., Hillier M.C. and Wall B.F. (2002). *Doses to Patients from Medical X-ray Examinations in the UK – 2000 Review*. National Radiological Protection Board, Chilton Didcot.

Hart D. and Wall B. F. (2003). The UK National Patient Dose Database: now and in the future. *British Jour. of Radiology* 76: 361 - 365

Hart D., Hillier M.C. and Wall B.F. (2009). National reference doses for common radiographic, fluoroscopic and dental X-ray examinations in the UK. *The British Journal of Radiology* 82: 1 – 12.

Health Canada (2011). Diagnostic X-ray Imaging Quality Assurance: An overview
Retrieved 17 May 2011 from [http://hc-sc.gc.ca/ewh-semt/pubs/radiation/quality-assurance art](http://hc-sc.gc.ca/ewh-semt/pubs/radiation/quality-assurance_art).

International Atomic Energy Agency (IAEA) (1996). *International Basic Safety Standards for Protection Against ionizing Radiation and for Safety of Radiation Sources*. Safety series No. 115-1. Vienna: IAEA.

International Atomic Energy Agency (IAEA) (2005). *Radiation Oncology Physics textbook. A handbook for teachers and student*. Chapter 14: Basic Radiobiology. IAEA, Vienna.

International Commission on Radiological Protection (1991). *1990 Recommendations of the International Commission on Radiological Protection*, ICRP publication 60, Ann ICRP 21: 1–3.

International Commission on Radiation Units and Measurements, ICRU Report 74 (2005). *Evolution of Radiation Dosimetry in Medical X-ray imaging: Late effects: Cancer Induction*. *Journal of the International Commission on Radiation Units and Measurement (ICRU)*, Vol. 5 (2), Oxford University Press.

International Radiological Protection and Safety in Medicine (1996). Publ. 73, Ann. International Commission on Radiation Protection, ICRP 26.

Ionizing Radiation Regulations (1988). Radiation Protection of Patients and Staff.
Published by the University of Leeds.

Jacobi W. (1975). The concept of effective dose: A proposal for the combination of organ doses. *Journal of Radiation Environ. Biophys.* 12: 101 – 109.

James F. (1980). Monte Carlo theory and practice. *Reports on progress in Physics* 43, 1145 – 1189.

James R. Connolly (2007): *Generation of X-rays: Introduction to x-ray powder Diffraction.*

Jaundrell-Thompson and Ashworth W.J. (1970). *X-ray physics and Equipment: Radiation Physics 2*, second edition. Blackwell scientific pub. Oxford and Edinburgh, pg. 721-753.

Jones D. G. and Wall B.F. (1985). Organ doses from medical x-ray examinations calculated using Monte Carlo techniques, NRPB-SR250 (NRPB, Chilton).

Kenneth L.M., Marviv G., Frank M., William A.M., Keith J.S., Richard L.V. (1996). *Radiation Risk in Perspective.* Health Physics Society publ. Retrieved 12 December from <http://www.physics.isu.edu/radinf/hprisk.htm>.

Kostas Perisinakis, John Damilakis, Nicholas Theocharopoulos, Emmanouel Manios, Panayiotis Vardas & Nicholas Gourtsoyiannis (2001). Accurate Assessment of Patient Effective Radiation Dose and Associated Detriment Risk From Radiofrequency Catheter Ablation Procedures. *Circulation* 104:58.

Klaus B., Evelien B., Regine L., Daniel De W. and Hubert T. (2005). Patient-Specific Dose and radiation risk estimate in pediatric cardiac catheterization. *Circulation* 111:83-89.

Kramer R., Zankl M., Williams G. and Drexler G. (1982). The calculation of dose from external photon exposures using reference human phantoms and Monte Carlo Methods, Part 1: The Male (ADAM) and Female (EVA) Adult Mathematical Phantoms. GSF-Bericht S-885.

Lagundoye S.B. (2002). Radiology train is on the move worldwide, come on board Nigeria, come on board. A convocation lecture delivered at the Nigerian National Postgraduate College, Ijanikin, Lagos state, on 19 September.

Le Heron J.C. (1992). Estimation of effective dose to the patient during medical x-ray examinations from measurements of the dose-area product. *Phys. Med. Biol.* 37:2117-2126.

Lubin J.H., Boice J.D., Edling C, Hornung R.W. et al. (1985). Lung cancer in radon-exposed miners and estimation of risk from indoor exposure. *J. Natl Cancer Inst.* 87:817-827.

Martin C.J. (2007). Effective dose: how should it be applied to medical exposure? *The British Journal of Radiology*, 80: 639 – 647.

Massey J. B (1977). Diagnostic Radiology. Proceedings of the International School of Physics, Italian physical Society: Health and Medical Physics.

Mcparland B.J. (1998). Entrance skin dose estimate derived from dose-area product measurements in interventional radiological procedures. *The British Journal of Radiology*, 71:175 – 185.

McNeil EA, Peach DE, Temperton DH (1995). Comparison of entrance surface doses and radiographic techniques in the wet Midlands (UK) with CEC criteria, specifically for lateral lumbar spine radiographs. *Radiat Prot Dosim* 57: 437 – 440

Mipem K-H NG, Rassiah P., Wang H-B, Hambali A.S, Muthuvellu P. and Lee H-P (1998). Doses to patients in routine X-ray examinations in Malaysia. The British Journal of Radiology, 71: 654 – 660.

Muhogora W.E., Nyanda A. M. (2001). The potential for reduction of radiation doses to patients undergoing some common X-ray examinations in Tanzania. Radiation Prot. Dosim 94: 381-4.

National Academies Press, NAP (2006). Health Risks from Exposure to low level of ionizing radiation: BEIR VII-phase 2 retrieved 10 October 2010 from <http://www.nap.edu/catalog/11340.html>.

National Cancer Institute, NCI (2006). What you need to know about cancer. US National Institutes of Health. Retrieved 20 November 2010 from <http://www.cancer.gov/cancertopics/wyntk/overview/page4>.

National Council on Radiation Protection and Measurements, NCRP (1989). Medical x-ray, electron beam and gamma ray protection for energies up to 50 MeV; Equipment design, performance and use. NCRP report no. 102. Bethesda, Md.

National Council on Radiation Protection and Measurements, NCRP (2002). Evaluation of the Linear-Non-Threshold Dose-Response Model for Ionizing Radiation (NCRP Report No 136). J. Radiol. Protec. 22:331-335.

National Research Council (1990). Health Effects of Exposure to Low Levels of Ionising Radiation, BEIR V. The National Academies Press, Washington, DC page 65 – 134.

National Research Council (2005). Health Risks from Exposure to Low Levels of Ionizing Radiation: BEIR VII Phase 2. The National Academies Press, Washington, DC page 267 – 312.

National Radiological Protection Board, (NRPB). (1992). National protocol for patient dose measurements in diagnostic radiology dosimetry, prepared by the Dosimetry Working Party of the Institute of Physical Sciences in Medicine NRPB. Retrieved 9 February, 2010 from <http://advice.hullrad.org.uk>

National Radiological Protection Board, (NRPB). (1994). Estimates of Radiation Detriment in UK Population. NRPB R260 Didcot, UK: National Radiological Protection Board.

Nave C.R.(2005). Hyperphysics; X-ray production. Retrieved 14 October 2009 from <http://hyperphysics.phy-astr.gsu.edu/HBASE/quantum/xtube.html>.

Nicholas Theocharopoulos, Kostas Perisinakis and John Damilakis (2001). Comparison of four methods for assessing patient effective dose from radiological examinations. Med.Phys 29 (9): 2070 – 2078.

Noel G (1996). Radiation Induced Cancer in Humans. Retrieved 5 May 2009 from http://trshare.triumf.ca/~safety/EHS/rpt/pt_4/node20.html.

Ogunseyinde, A.O. (2009). Darkness to light: Evolution and unmasking of shadows and images. An inaugural lecture delivered at the University of Ibadan on 8 January.

Ogundare, F.O., Uche C.Z., Balogun F.A. (2004). Radiological parameters and radiation doses of patients undergoing abdomen, pelvis and lumbar spine x-ray examinations in three Nigerian hospitals. The Brit. Jour. Radiol. 77: 934 – 940.

Ogunseyinde, A. O., Adeniran S.A.M., Obed R.I., Akinlade B.I., Ogundare F.O. (2001). Comparison of entrance surface doses of some x-ray examinations with CEC reference doses. *Radiation Protection Dosim.* 98 (2): 231 – 234.

Perry Sprawls, Jr (1987). *Physical Principles of Medical Imaging: Textbook* published by Aspen Publication, Rockville, Maryland Royal Tunbridge Wells.

Perry Sprawls, Ph.D (2011). *Physical Principles of Medical Imaging: Online textbook* of Sprawls Educational Foundation: Radiation Penetration. Retrieved 16 May 2011 from <http://www.sprawls.org/ppmi2/RADPEN>.

Phil Rutherford (2002). *Radiation Risk: A critical look at Real and Perceived Risks from Radiation Exposure.* Retrieved 12 December 2008 from http://www.philrutherford.com/Radiation_Risk/Radiation_Risk.pdf.

Rannikko S., Ermakov I., Lampinen J. S., Toivonen M., Karila KTK and Chervjakov A. (1997). Computing patient doses of x-ray examinations using a patient size- and sex-adjustable phantom. *Br. J. Radiol.* 70: 708-718.

Reactor Concepts Manual (2009): *Biological Effects of Radiation.* USNRC technical training centre retrieved 11 October 2010 from <http://www.nrc.gov/reading-rm/basic-ref/teachers>

Robert A. Parry, Sharon A. Glaze, Benjamin R. Archer (1998). Typical patient Radiation Doses in Diagnostic Radiology. *Radiographics* 19: 1289 – 1302.

Rosenstein M. (1976). *Organ doses in Diagnostic Radiology.* Hew publication FDA 76-8030 (U.S. Department of Health, Education and Welfare, Public Health Services, Food and Drug Administration, Bureau of Radiological Health, Rockville, MD).

Rosenstein M. and L. W. Anderson (1976). Handbook of Selected Organ Doses for Projections Common in Diagnostic Radiology. Hew publication FDA 76-8030 (U.S. Department of Health, Education and Welfare, Public Health Services, Food and Drug Administration, Bureau of Radiological Health, Rockville, MD).

Rosenstein M. (1976). Handbook of Selected Tissue Doses for Projections Common in Diagnostic Radiology. Hew publication FDA 76-8030 (U.S. Department of Health, Education and Welfare, Public Health Services, Food and Drug Administration, Bureau of Radiological Health, Rockville, MD).

Schandorf C, Tetteh G. K. (1998). Analysis of dose and dose distribution for patients undergoing selected X-ary diagnostic procedures in Ghana. Radiat Protection Dosim 76: 249 – 56.

Schultz, F. W., Geleijns, J., Spoelstra, F. M., & Zoetelief, J. (2003). Monte Carlo calculations for assessment of radiation dose to patients with congenital heart defects to staff during cardiac catheterizations. British Journal of Radiology 76 : 638-647.

Servomaa, A., & Tapiovaara, M. (1998). Organ Dose Calculation in Medical X- Ray Examinations by the Program PCXMC. Radiation Protection Dosimetry 80 (1-3):213-219, Nuclear Technology Publishing.

Shope T.B. (1996). Radiation-induced skin injuries from fluoroscopy. RadioGraphics 16: 1195 – 1200.

Shrimpton P.S., Wall B. F., Hart D. (1999). Diagnostic medical exposures in the UK. Applied Radiation and Isotopes 50: 261 – 269.

- Sola Ogundipe and Chioma obinna (2008). Why Cancer is on the Rise in the Country. Retrieved 17 June 2008 from Allafrikan.com: Nigeria.
- Sridhar M.K.C., Gree A., Oloruntoba E.O. and Olowu A.O. (2009). Built environment and cancers- Are our homes safe? *Afr. J. Med. med. Sci.* 38, 261- 270.
- Stanton L., Villafana T., Day J. and Lightfoot D. (1984). Dosage evaluation in Mammography. *Radiology* 150: 577 – 584.
- Suliman I. I., Abbas N, and Habbani F. I. (2007). Entrance surface doses to patients undergoing selected diagsotci X-ray examinations in Sudan. *Radiat. Protection Dosimetry* 123 (2): 209 – 214.
- Teresa Lohr (1999). Using health studies to understand your risk from Radiation Exposure: A guide to risk estimates and statistics. A publication of the Hanford Health Information Network. Retrieved 11 December 2006 from <http://www.doh.wa.gov/hanford/publications/overview/risk.html>.
- Teresa Lohr (2004). *Epidemiology: Understanding Health Studies*. A publication of the Hanford Health Information Network. Retrieved 11 December 2006 from <http://www.doh.wa.gov/hanford/publications/overview/epidemiology.html>.
- The National Academies Press (NAP) (1998). *Health Effects of Exposure to Low Levels of Ionizing Radiations: Time for reassessment?*
- Thompson D.E., Mabuchi K., Ron E., Soda M. et al (1994). Cancer incidence in atomic bomb survivors. Part II: solid tumors, 1958 – 1987. *Radiat Res* 137: S17-S67.

United Nations Scientific Committee on the Effects of Atomic Radiation (UNSCEAR) Report Vol II (2000). Sources and effects of ionizing radiation. Annex G: Biological effects at low radiation doses, paragraph 541, pg 160.

Upton A.C. (2003). The state of the art in the 1990s. NCRP report No. 136 on the Scientific bases for linearity in the dose-response relationship for ionizing radiation. Health Physics 85:15–22.

Viktorie and Stisova (2004). Effective dose to patient during cardiac interventional procedures (Prague workplaces). Radiation Protection Dosimetry 111(3):271-274.

Waller D. and Hofmann B. (2010). Image rejects/retakes – radiographic challenges. Radiation Protection Dosimetry 139 (1-3): 375 – 379.

Wall B. F. and D. Hart (1997). Commentary: Revised radiation doses for typical x-ray examinations. Report on a recent review of doses to patients from medical examinations in the UK by NRPB. Br. J. Radiol.70, 437 – 439.

Wanebo C.K, Johnson K.G, Sato K. and Thorslund T.W. (1968). Breast cancer after exposure to the atomic bombings of Hiroshima and Nagasaki. The New England Journal of Medicine 279:667- 671.

World Health organization (2008). 2008 World Cancer Report: comprehensive global examination of the disease issued by the IARC- a part of the WHO.

Yakoumakis E, Tsalafouta I.A., Nikolaou D., Nazos I., Koulentianos E. and Proukakis C. H. (2001). Differences in effective dose estimation from dose-area product and entrance surface dose measurements in intravenous urography. Br. J. Radiol. 74: 727-734.

CHAPTER FOUR

RESULTS

Table 4.1: Radiation Exposure per tube loading

X-ray centre	Beam Output ($\mu\text{R mAs}^{-1}$) for various kVp								
	50 kVp	60 kVp	65 kVp	70 kVp	75 kVp	80 kVp	85 kVp	90 kVp	100kVp
<i>This study</i>									
UCH	945	1095	-	1152	-	1281	-	1437	1455
TDC	-	307	-	319	337	353	398	441	-
OAUTHC	-	293	-	389	-	531	-	999	218
NHA	306	598	-	918	-	-	161	-	225
<i>Other studies</i>									
Yakoumakis (2001)	-	1936	-	2898	-	4055	-	5349	6770
Suliman (2007)	-	-	-	-	-	*5551	-	-	-

Table 4.2: Radiation Dose per tube loading

X-ray centre	Beam Output ($\mu\text{Gy mAs}^{-1}$) for various kVp								
	50 kVp	60 kVp	65 kVp	70 kVp	75 kVp	80 kVp	85 kVp	90 kVp	100kVp
<i>This study</i>									
UCH	8.25	9.56	-	10.1	-	11.2	-	12.6	12.7
TDC	-	2.68	2.78	2.94	3.09	3.48	3.85	-	-
OAUTHC	-	2.56	-	3.39	-	4.64	-	8.72	19.01
NHA	2.67	5.22	-	8.02	-	-	14.07	-	19.61
<i>Other studies</i>									
Yakoumakis (2001)	-	16.90	-	25.30	-	35.40	-	46.70	59.10
Suliman (2007)	-	-	-	-	-	*48.5	-	-	-

*Average beam output per tube loading of eight x-ray units measured at 80 kVp

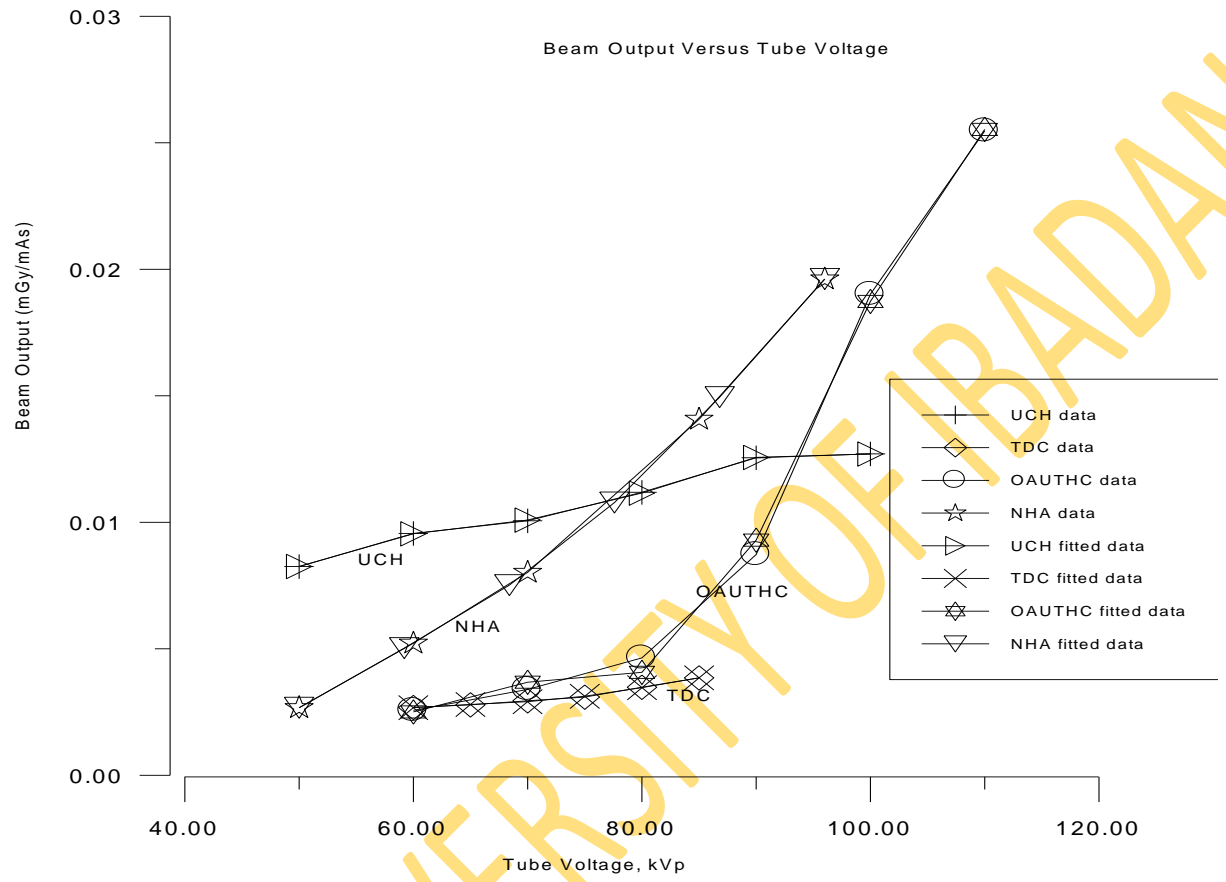

Fig. 4.1 The comparison of values of beam output obtained from centers and those fitted to equation (3.1) for different values of kVp

Table 4.3: Values of a_0 , a_1 , a_2 , a_3 , a_4 and regression coefficient (R^2) per centre

X-ray centre	Values of a_0 , a_1 , a_2 , a_3 , a_4 and R^2					
	a_0	a_1	a_2	a_3	a_4	R^2
UCH	-0.1545	0.0092	-19E-04	1.8E-06	-6.0E-09	0.9998
TDC	-0.1763	0.0099	-21E-05	1.9E-06	-6.5E-09	0.9968
OAUTHC	-1.1204	0.0571	-11E-04	8.7E-06	-2.6E-08	0.9982
NHA	-0.0814	0.0046	-9.5E-05	8.9E-07	-3.0E-09	1.0000

UNIVERSITY OF IBADAN

Table 4.4: Demographic information of patients at various centres

<i>Centres considered in this study</i>				
<u>Demographic data</u>	<u>UCH</u>	<u>TDC</u>	<u>OAUTHC</u>	<u>NHA</u>
Sex: Male	173 (56 %)	164 (59%)	130 (59%)	124 (54%)
Female	137 (44%)	112 (41%)	90 (41%)	104 (46%)
Age (yr): Male	35 ± 19	31 ± 17	27 ± 13	27 ± 10
Female	42 ± 17	34 ± 16	27 ± 16	30 ± 14
Weight (kg): Male	57 ± 16	63 ± 11	59 ± 13	63 ± 12
Female	61 ± 15	60 ± 13	54 ± 11	62 ± 17
Height (cm): Male	159 ± 15	164 ± 7	161 ± 12	164 ± 7
Female	162 ± 13	162 ± 8	157 ± 10	162 ± 13
BMI (kg/m²): Male	22 ± 3	23 ± 2	23 ± 2	23 ± 2
Female	23 ± 3	23 ± 2	21 ± 2	23 ± 3

Table 4.5: Type of Radiographic examination and projection per x-ray centre

X-ray centre	Type of Radiographic examination and projection					
	Head & Neck (AP, PA & LAT)	Upper Limb (AP & LAT)	Thoracic (AP, PA & LAT)	Abdomen (AP & PA)	Pelvic (AP & LAT)	Lower limb (AP & LAT)
UCH	95 (26 %)	5 (1 %)	200 (54 %)	4 (1%)	46 (12%)	20 (5%)
TDC	8 (3 %)	5 (2 %)	192 (75 %)	9 (4%)	27 (11%)	16 (6%)
OAUTHC	2 (1 %)	NA	191 (98 %)	NA	NA	2 (1%)
NHA	8 (4 %)	NA	180 (85 %)	3 (1%)	14 (7%)	8 (4%)
Total	113 (11 %)	10 (1 %)	763 (74 %)	16 (2 %)	87 (8 %)	46 (4 %)

Table 4.6: Average Values of Exposure Parameters (kVp and mAs) used for different Radiographic Examination at various centres considered in this study

Radiographic examination and its exposure parameters												
X-ray Centre	Head & Neck		Upper Limb		Thoracic		Abdomen		Pelvic		Lower limb	
	kVp	mAs	kVp	mAs	kVp	mAs	kVp	mAs	kVp	mAs	kVp	mAs
UCH	66	30	59	11	70	49	78	60	82	100	61	19
TDC	78	93	74	57	79	76	80	95	77	94	68	61
OAUTHC	100	128	NA		107	73	NA		NA		92	48
NHA	71	23	NA		73	28	83	40	81	37	66	13

NA: Not Applicable

Table 4.7: Application of grid (Yes or No) during radiological procedure at the centres considered in this study.

X- ray Centre	Radiological procedure and application of grid					
	Head & Neck	Upper Limb	Thoracic	Abdomen	Pelvic	Lower limb
UCH	Yes	No	No	Yes	Yes	No
TDC	Yes	No	No	Yes	Yes	No
OAUTHC	Yes	NA	Yes	NA	NA	No
NHA	Yes	NA	No	Yes	Yes	No

NA: Not Applicable

Table 4.8: Rejection Analysis of Radiographic films at the centres considered in this study

X- ray	Radiographic examination with the number of accepted film (A) and rejected films (R)											
	Head & Neck		Upper limb		Thoracic		Abdomen		Pelvic		Lower limb	
	A	R	A	R	A	R	A	R	A	R	A	R
UCH	86	9	5	0	188	12	3	1	39	7	20	0
TDC	6	2	5	0	189	3	9	0	26	1	11	5
OAUTHC	2	0	NA		189	2	NA		NA		2	0
NHA	8	0	NA		176	4	3	0	14	0	8	0

NA: Not Applicable

Table 4.9.0: Dose Area Product (mGy.cm²) for various radiographic examination at centres considered in this study.

X- ray Centre	Dose Area Product (mGy.cm ²)					
	Head & Neck	Upper limb	Thoracic	Abdomen	Pelvic	Lower limb
<u>This study</u>						
UCH	122	70	250	451	593	161
TDC	232	94	337	748	324	194
OAUTHC	23,190	NA	26,074	NA	NA	1299
NHA	152	NA	230	520	310	115
<u>Literature</u>						
UK	NA	NA	120	3000	3000	NA

NA: Not Applicable

Table 4.9.1: Comparison between the Entrance Skin Dose values (mGy) obtained in this study with ESD from published studies.

	Entrance Skin Dose (mGy)												
	This Study				Other Studies								
X-ray Examination	UCH	TDC	OAUTHC	NHA	Ogunseyinde et al (2001) (PA)	Ajayi and Akinwumiju (2000)	CEC (1996) (PA)	Mcparland (1998) (PA)	Nicholas et al (2001)	Mipem et al (1998)	Shrimpton (1995)	IAEA (1996)	UK (2002)
Head & Neck (AP, PA & LAT)	0.383	0.678	9.180	0.666	8.60	3.00	5.00	4.10	0.92	4.70	3.00	5.00	2.25
Upper limb (AP & LAT)	0.296	0.434	NA	NA	NA	NA	NA	NA	NA	NA	NA	NA	NA
Thoracic (AP, PA & LAT)	0.468	1.606	3.730	0.410	0.20	0.40	0.30	NA	0.22	0.30	0.16	0.40	3.68
Abdomen (AP & PA)	0.585	1.199	NA	0.697	NA	NA	NA	2.50	1.14	10.00	5.60	10.00	6.00
Pelvic (AP & PA)	2.577	0.849	NA	1.267	NA	NA	10.00	NA	NA	5.30	4.40	10.00	4.00
Lower limb (AP & LAT)	0.571	0.969	3.470	0.273	NA	NA	NA	NA	NA	NA	NA	NA	NA

NA: Not Applicable; CEC: Commission of the European Communities; PA: posteroanterior; AP: anteropostero; LAT: lateral

Table 4.9.2: Typical organs and effective doses calculated by PCXMC program

Header:	Chest examination	
Projection:	90.0000 (PA)	
Obl. Angle:	0.0000	
Age:	30 years	
Length:	159.8606 cm	
Mass:	56.0000 kg	
Arms in phantom:	1	
FSD:	129.4800 cm	
X-ray beam width:	30.2100 cm	
X-ray beam height	30.2100 cm	
Xfocus:	0.2707	
Yfocus:	138.7380	
Zfocus:	47.1063	
NELevels:	15	
NPhotos:	20000	
XYscale:	0.9259	
Zscale:	0.9187	
X-ray tube voltage (kV):	80	
Filter:	0.7 mm Al + 2 mm Al	
SurfDose:	0.1837 mGy	
Organ:	Dose (mGy):	Error (%):
Ovaries	0.000000	NA
Testes	0.000000	NA

Active bone marrow	0.030285	0.4
Skeleton	0.070198	0.5
Lungs	0.099492	1.0
Lower large intestine	0.000184	21.1
Stomach	0.019834	3.8
Liver	0.043877	1.1
Thyroid	0.006650	16.4
Oesophagus	0.039151	5.9
Breasts	0.018855	3.9
Urinary bladder	0.000039	79.8
Skin	0.022672	0.9
Adrenals	0.119021	7.0
Brain	0.000265	14.3
Kidneys	0.044927	2.6
Pancreas	0.042050	4.9
Small intestine	0.001527	7.1
Upper large intestine	0.001792	10.0
Spleen	0.088755	2.5
Thymus	0.013765	11.8
Uterus	0.000552	34.6
Remainder (muscle)	0.020425	0.2
Gall bladder	0.011909	11.7
Heart	0.036837	2.4
Total Body	0.028610	0.1
Effective dose (mSv)	0.027916	1.0
Abs. fraction (%)	69.663918	

Table 4.9.3: Comparison between the values of effective dose (mGy) obtained in this study with those from other studies for similar x-ray examinations

X-ray Examination	Effective Dose (mGy)									
	This Study				Other Studies					
	UCH	TDC	OAUTHC	NHA	Ogundare et al (2004)	Schandorf et al (1998)	Muhogora et al (2001)	Wall BF et al (1997)	Mipem et al (1998)	Shrimpton et al (1999)
Head & Neck (AP, PA & LAT)	0.01	0.04	2.16	0.01	NA	NA	NA	0.02	3.89	0.03
Upper limb (AP & LAT)	0.01	0.07	NA	NA	NA	NA	NA	NA	NA	NA
Thoracic (AP, PA & LAT)	0.02	0.04	4.74	0.01	NA	NA	NA	0.19	5.94	0.19
Abdomen (AP & PA)	0.35	1.10	NA	0.60	0.33	1.71	0.65	0.70	9.22	0.70
Pelvic (AP & PA)	0.61	0.54	NA	0.55	0.33	1.71	0.62	0.70	5.33	0.66
Lower limb (AP & LAT)	0.01	0.01	0.24	0.01	NA	NA	NA	NA	NA	NA

NA: Not Applicable; CEC: Commission of the European Communities; PA: posteroanterior; AP: anteropostero; LAT: lateral

Table 4.9.4: Radiation detriment (with respect to various organs) associated with different radiological examination at the centres.

a. Head & Neck Examination

	Tissue/Organ (10^{-6}Sv^{-1})												Sum
	Red Blood marrow	Colon	Lung	Stomach	Bladder	Breast	Liver	Oesophagus	Thyroid	Skin	Bone surface	Remainder	
Centre:													
UCH	0.40	0.60	0.60	0.80	0.20	0.10	0.10	0.20	0.10	0.01	0.04	0.40	3.60
TDC	0.50	0.80	0.80	1.00	0.30	0.20	0.10	0.30	0.10	0.02	0.05	0.50	4.70
OAUTHC	10	8	8	8	6	8	13	12	15	10	11	11	120
NHA	0.50	0.80	0.80	1.00	0.30	0.20	0.10	0.30	0.10	0.02	0.05	0.50	4.70

b. Upper limb Examination

	Tissue/Organ (10^{-6}Sv^{-1})												Sum
	Red Blood marrow	Colon	Lung	Stomach	Bladder	Breast	Liver	Oesophagus	Thyroid	Skin	Bone surface	Remainder	
Centre:													
UCH	0.30	0.40	0.40	0.60	0.20	0.10	0.10	0.20	0.04	0.01	0.03	0.30	2.70
TDC	0.40	0.60	0.60	0.80	0.20	0.10	0.10	0.20	0.10	0.01	0.04	0.40	3.60
OAUTHC	NA	NA	NA	NA	NA	NA	NA	NA	NA	NA	NA	NA	NA
NHA	NA	NA	NA	NA	NA	NA	NA	NA	NA	NA	NA	NA	NA

NA: Not Applicable

Table 4.9.4 contd.

c. Thoracic Examination

	Tissue/Organ (10^{-6}Sv^{-1})												
	Red Blood marrow	Colon	Lung	Stomach	Bladder	Breast	Liver	Oesophagus	Thyroid	Skin	Bone surface	Remainder	Sum
Centre:													
UCH	0.90	1.50	1.50	2.00	0.20	0.40	0.30	0.50	0.10	0.04	0.09	0.60	8.40
TDC	2.00	4.00	4.00	5.00	0.30	0.90	0.70	1.30	0.30	0.10	0.20	2.00	21.80
OAUTHC	25	26	26	25	26	26	25	25	26	23	22	25	300
NHA	0.60	0.90	0.90	1.20	0.30	0.20	0.20	0.30	0.10	0.02	0.06	0.60	5.40

d. Abdominal Examination

	Tissue/Organ (10^{-6}Sv^{-1})												
	Red Blood marrow	Colon	Lung	Stomach	Bladder	Breast	Liver	Oesophagus	Thyroid	Skin	Bone surface	Remainder	Sum
Centre:													
UCH	0.50	0.80	0.80	1.00	0.30	0.20	0.10	0.30	0.10	0.02	0.05	0.50	4.70
TDC	0.90	1.50	1.50	1.90	0.50	0.30	0.30	0.50	0.10	0.03	0.09	0.90	8.52
OAUTHC	NA	NA	NA	NA	NA	NA	NA	NA	NA	NA	NA	NA	NA
NHA	0.40	0.60	0.60	0.80	0.20	0.10	0.10	0.20	0.10	0.01	0.04	0.40	3.60

NA: Not Applicable

Table 4.9.4 contd.

e. Pelvic Examination per centre

	Tissue/Organ (10^{-6}Sv^{-1})												Sum
	Red Blood marrow	Colon	Lung	Stomach	Bladder	Breast	Liver	Oesophagus	Thyroid	Skin	Bone surface	Remainder	
Centre:													
UCH	0.60	0.90	0.90	1.20	0.30	0.20	0.20	0.30	0.10	0.02	0.06	0.60	5.40
TDC	0.30	0.40	0.40	0.60	0.20	0.10	0.10	0.20	0.04	0.01	0.03	0.30	2.70
OAUTHC	NA	NA	NA	NA	NA	NA	NA	NA	NA	NA	NA	NA	NA
NHA	0.30	0.40	0.40	0.60	0.20	0.10	0.10	0.20	0.04	0.01	0.03	0.30	2.70

NA: Not Applicable

f. Lower limb Examination per centre

	Tissue/Organ (10^{-6}Sv^{-1})												Sum
	Red Blood marrow	Colon	Lung	Stomach	Bladder	Breast	Liver	Oesophagus	Thyroid	Skin	Bone surface	Remainder	
Centre:													
UCH	0.50	0.80	0.80	1.00	0.30	0.20	0.10	0.30	0.10	0.02	0.05	0.50	4.70
TDC	0.60	0.90	0.90	1.20	0.30	0.20	0.20	0.30	0.10	0.02	0.06	0.60	5.40
OAUTHC	1.50	2.20	0.20	2.10	1.10	0.70	0.60	1.10	0.30	0.07	0.19	1.90	12.00
NHA	0.20	0.30	0.30	0.30	0.10	0.10	0.10	0.10	0.10	0.02	0.02	0.20	3.90

Table 4.9.5: Estimated Risk of fatal cancer associated with different radiological examination at the centres considered in this study.

X- ray Centre	Estimated risk of fatal cancer (per million patients)					
	Head & Neck	Upper limb	Thoracic	Abdomen	Pelvic	Lower limb
UCH	3 – 4	2 – 3	8 – 9	4 – 5	5 – 6	4 - 5
TDC	4 – 5	3 – 4	21 – 22	8 – 9	2 – 3	5 - 6
OAUTHC	180 – 200	NA	100 – 400	NA	NA	10 - 15
NHA	4 – 5	NA	5 – 6	3 - 4	2 – 3	3 – 4

NA: Not Applicable

Table 4.9.6: Modal Ranges of measurable quantities at the centres

	<i>Examination type</i>	<i>Age range (year)</i>	<i>Sex</i>	<i>BMI range (kgm⁻²)</i>	<i>kVp range</i>	<i>mAs range</i>	<i>DAP range (mGy.cm²)</i>	<i>ESD range (mGy)</i>	<i>Effective dose range (mSv)</i>	<i>Risk range (x 10⁻⁶)</i>
<i>Centre</i>										
UCH	Thoracic	42 – 50	Male	21 – 25	56 – 60	< 35	0 – 100	0.05 – 0.50	0.01 – 0.05	8 - 9
TDC	Thoracic	21 – 30	Male	21 – 25	76 – 80	35 – 50	101 – 200	0.05 – 0.50	0.01 – 0.05	21 - 22
OAUTHC	Thoracic	21 – 30	Male	21 – 25	> 105	76 – 100	30001 – 40000	3.10 – 3.50	2.60 – 3.00	151 - 200
NHA	Thoracic	21 – 30	Male	21 – 25	66 – 70	< 35	101 - 200	0.05 – 0.50	0.01 – 0.05	5 - 6

Fig 4.2: Bar Charts showing frequency group distribution of x-ray examination, Age, sex, Body Mass Index (BMI) , kV, mAs, Dose Area Product (DAP), Entrance skin Dose (ESD), Effective dose and Risk of cancer at the centres considered for this study

(i) X-ray Examination group

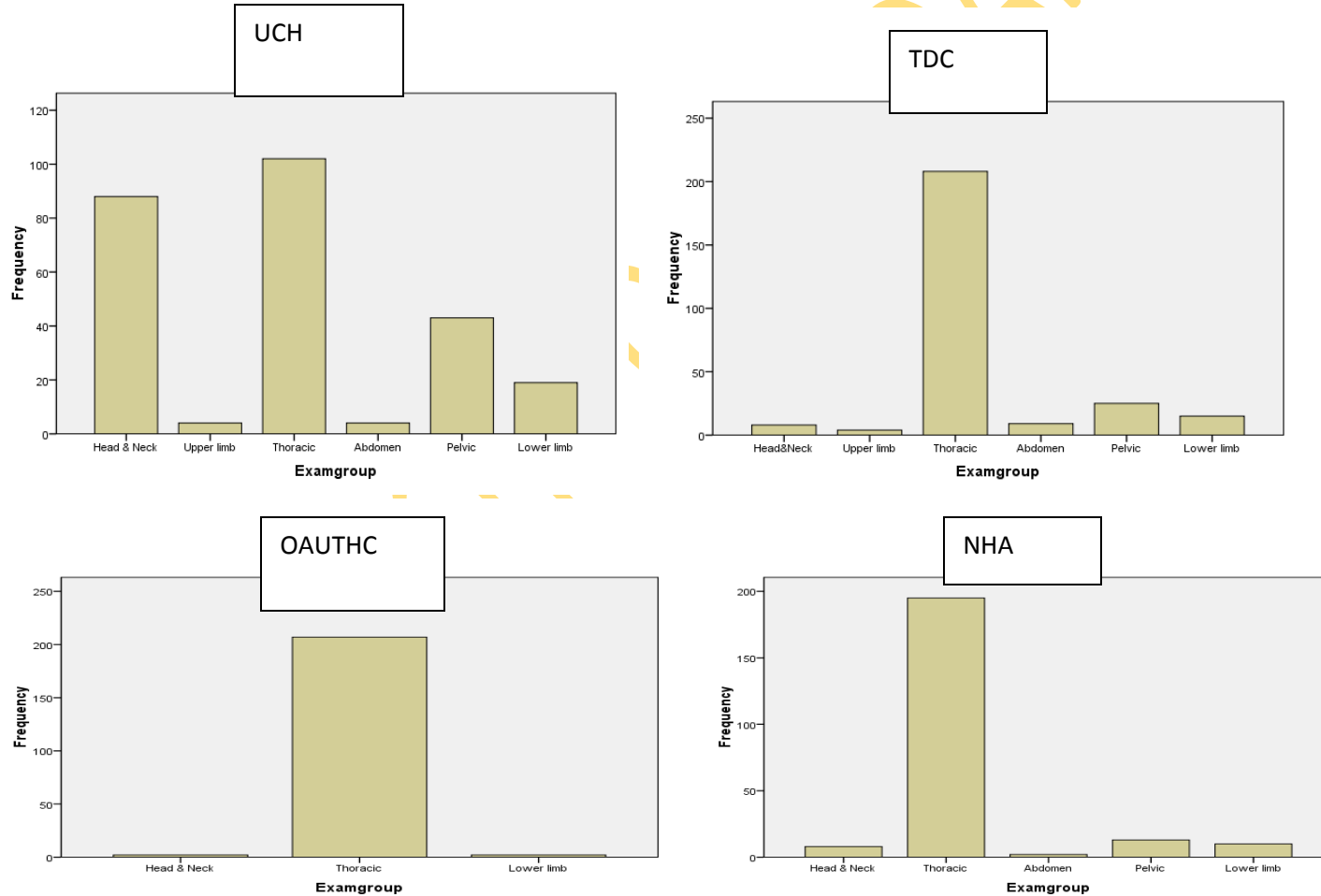

Fig. 4.2 contd.

(ii) *Age group distribution*

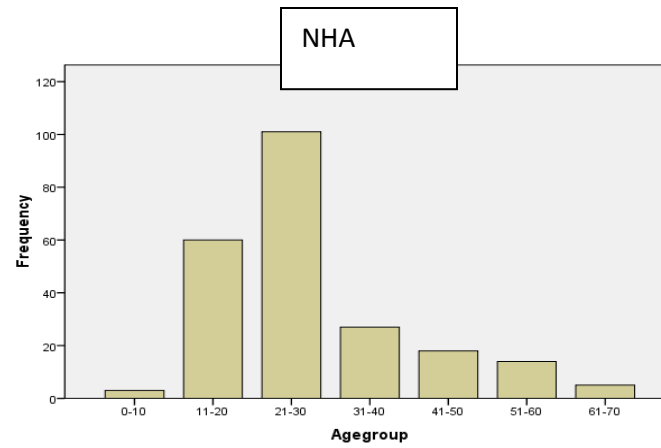
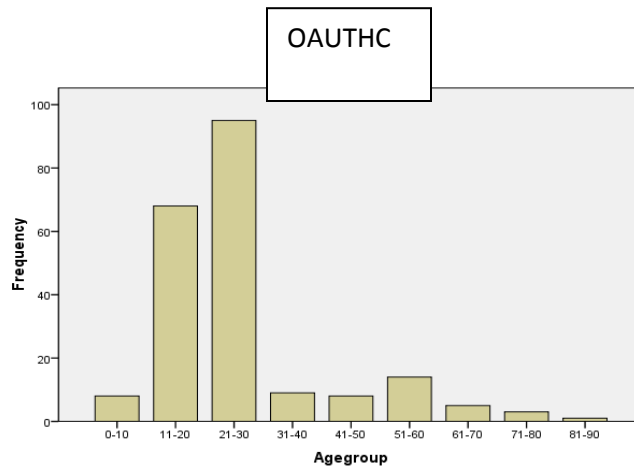
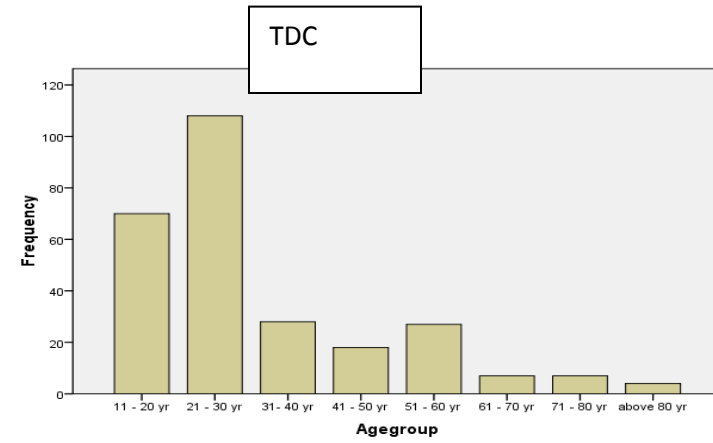
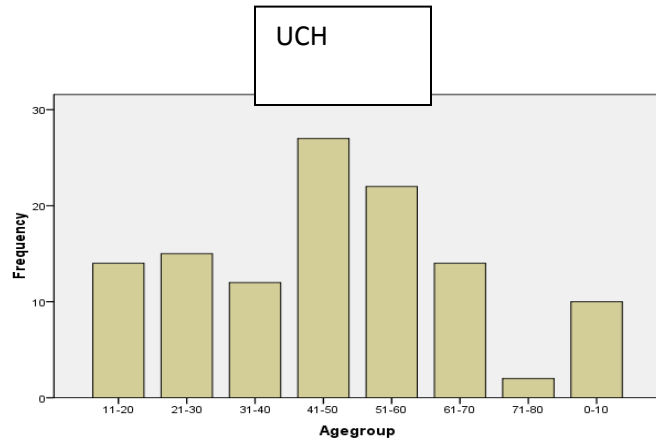

Fig. 4.2 contd.

(iii) Sex distribution

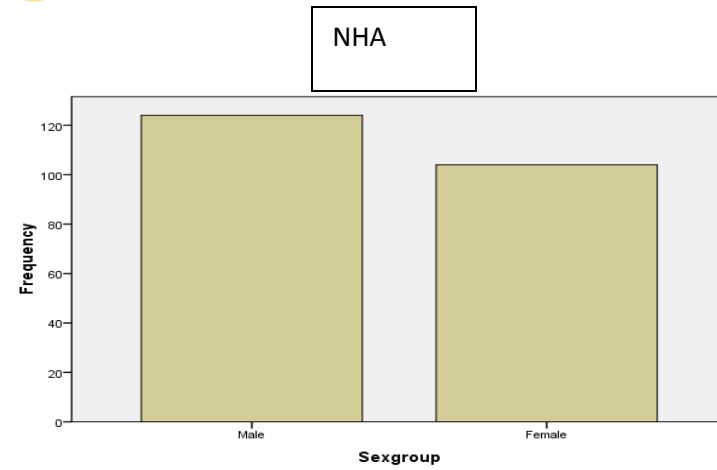
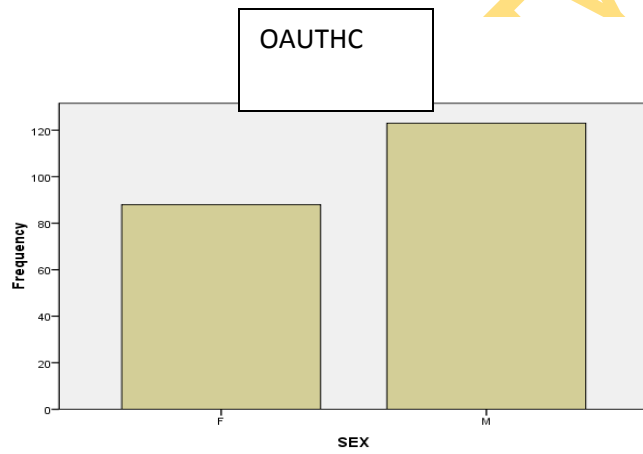
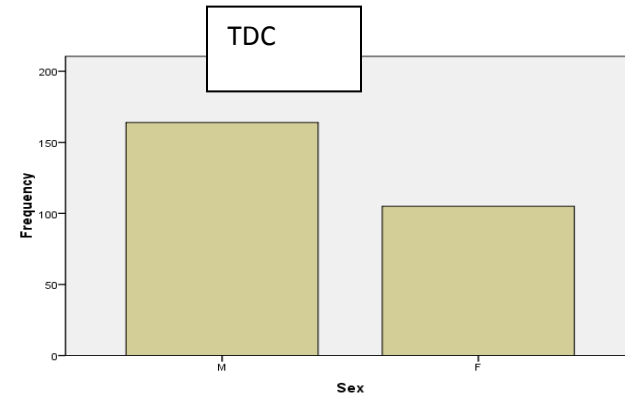
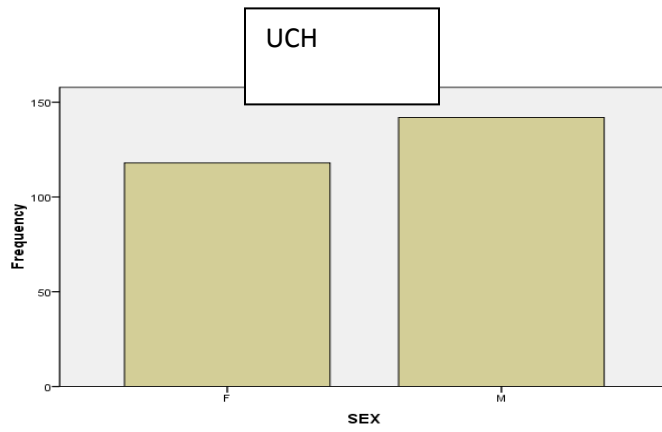

Fig. 4.2 contd.

(iv) *BMI group distribution*

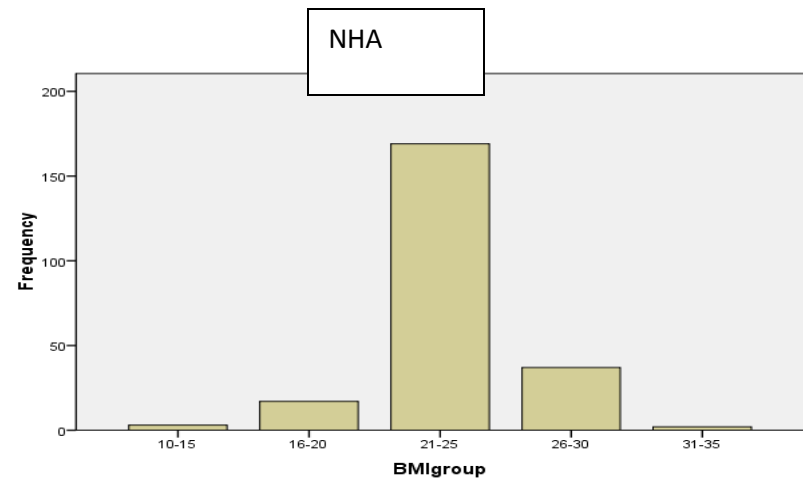
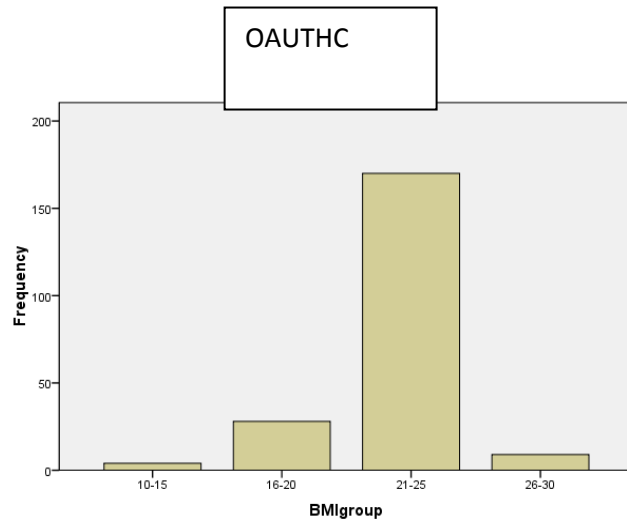
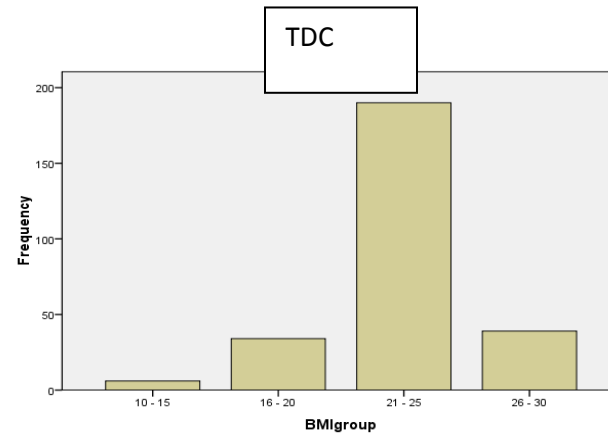
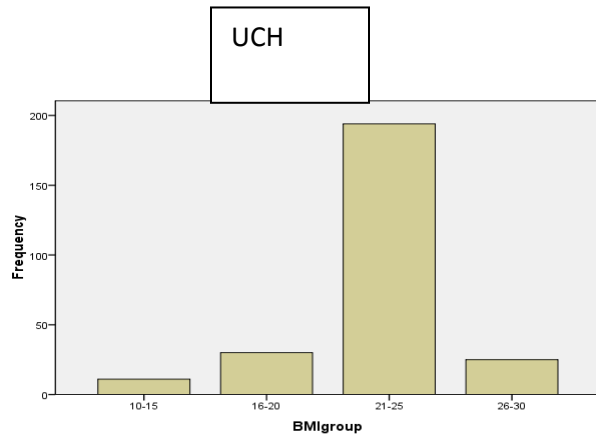

Fig. 4.2 contd.

(v) *kVp* group distribution

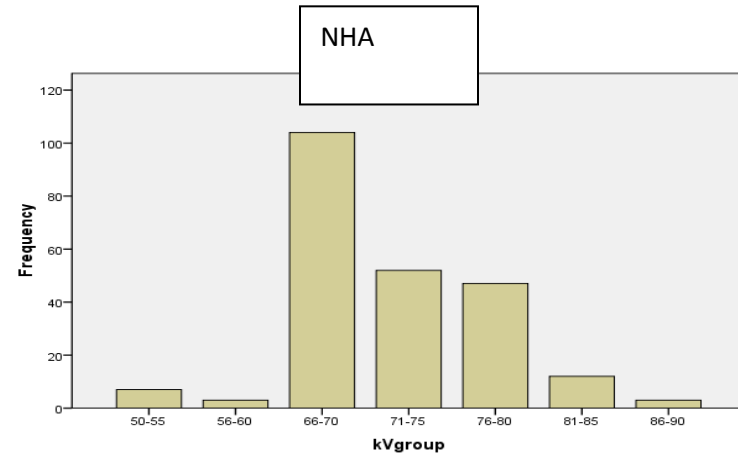
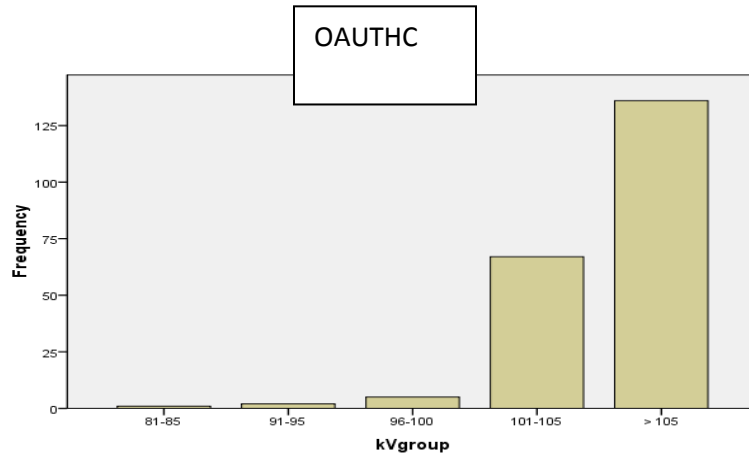
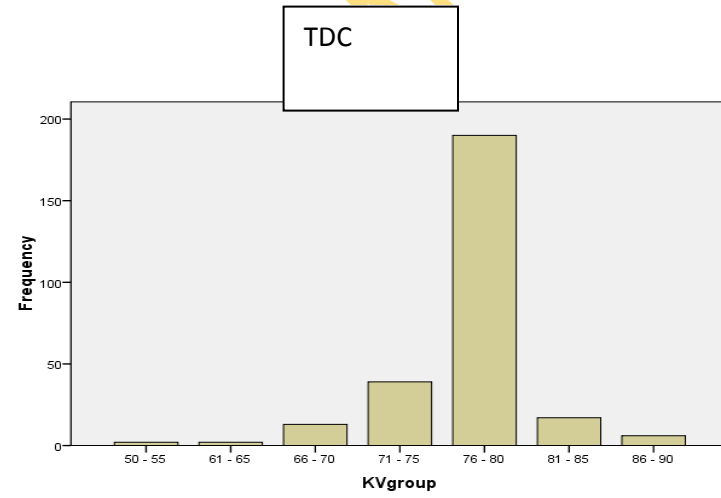
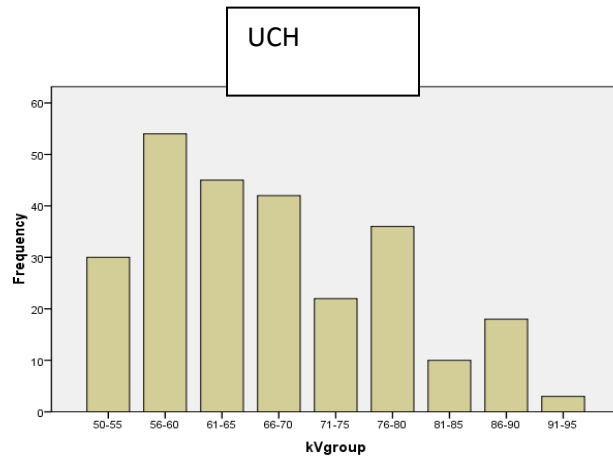

Fig. 4.2 contd.

(vi) mAs group distribution

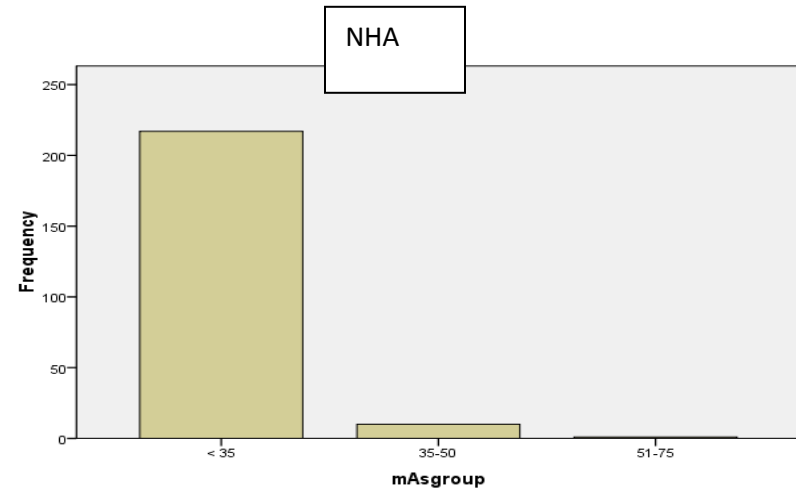
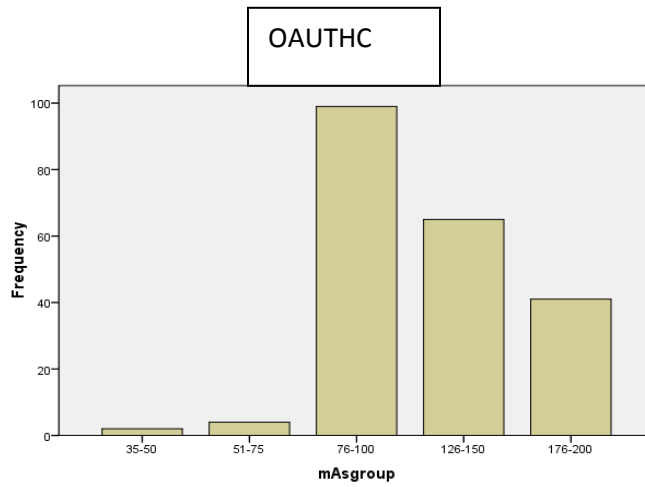
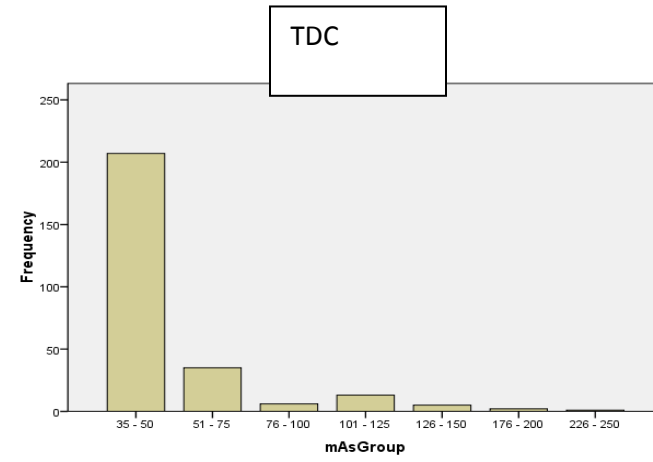
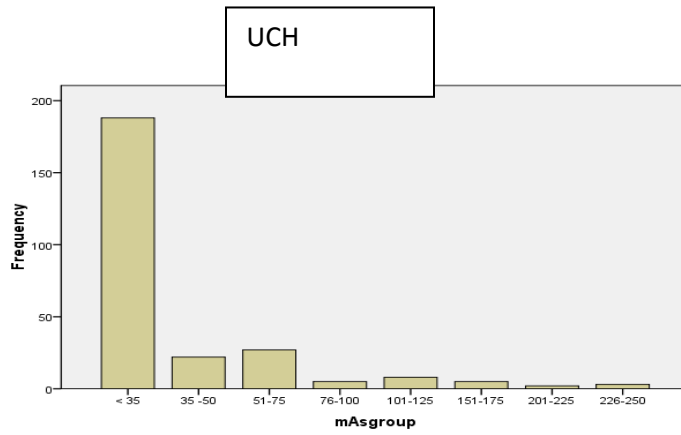

Fig. 4.2 contd.

(vii) DAP group distribution

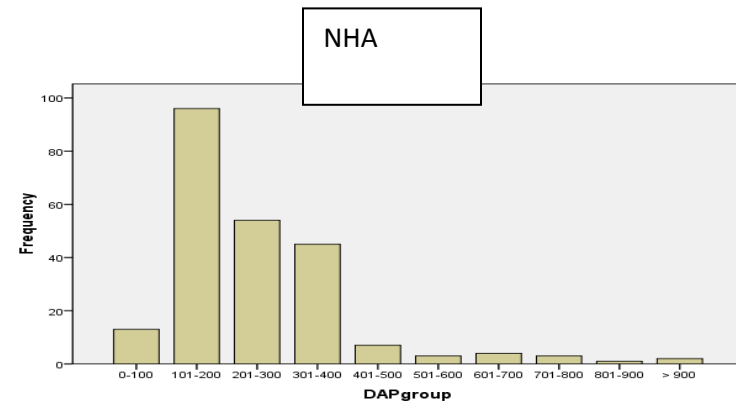
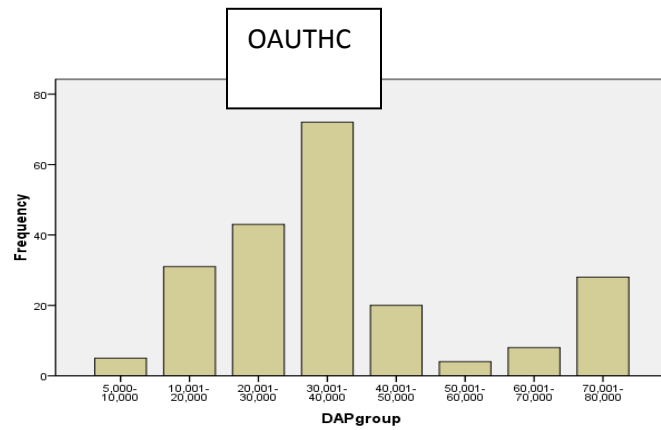
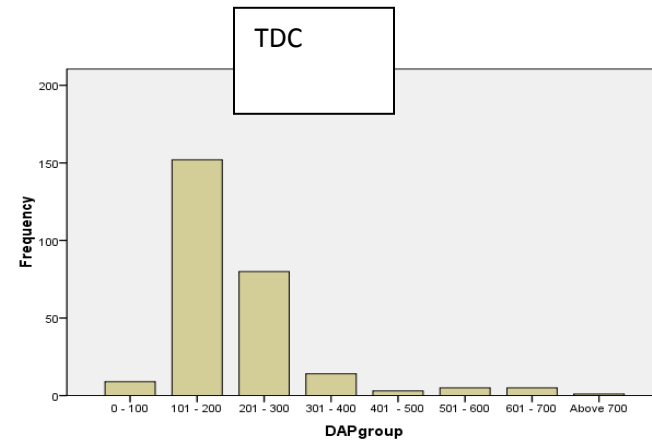
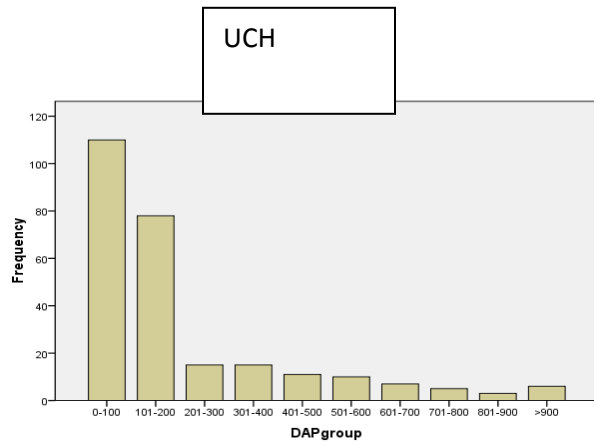

Fig. 4.2 contd.

(viii) *ESD group distribution*

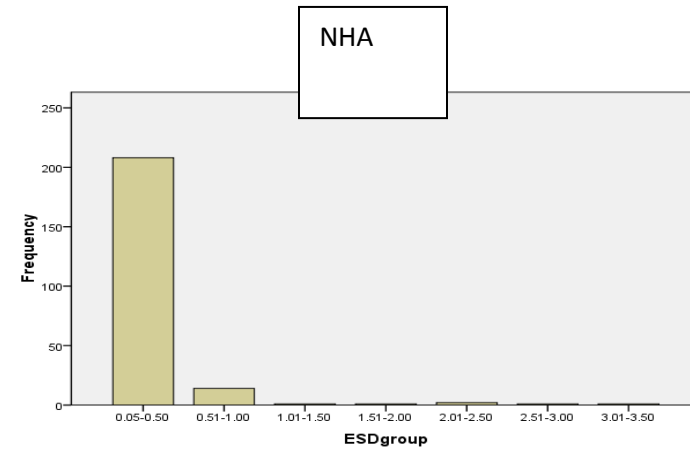
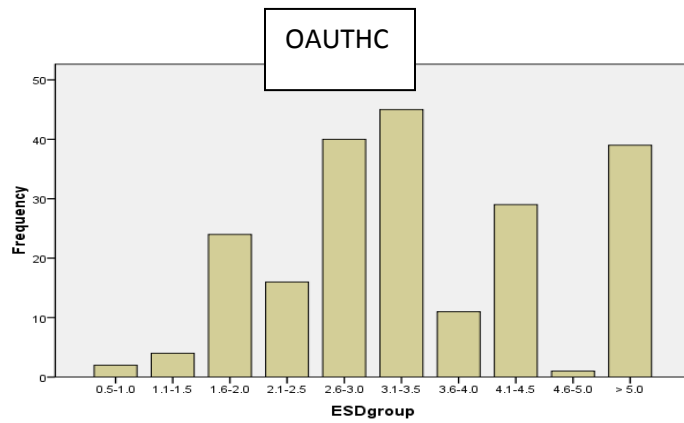
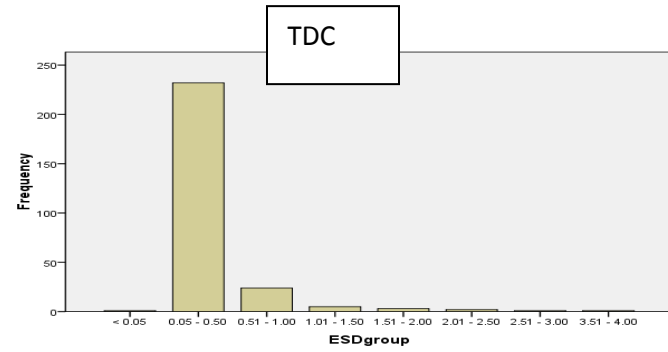
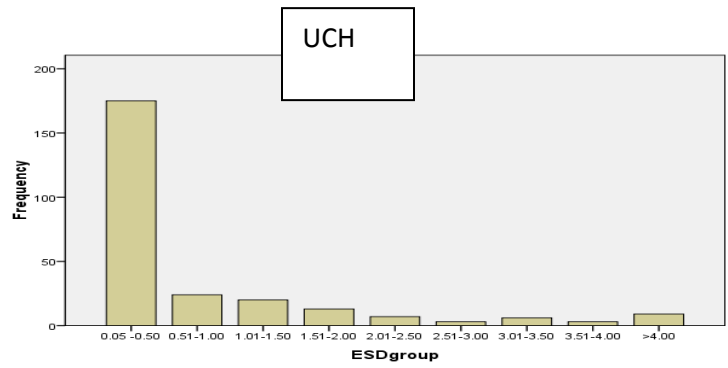

Fig. 4.2 contd.

(ix) *Effective dose group distribution*

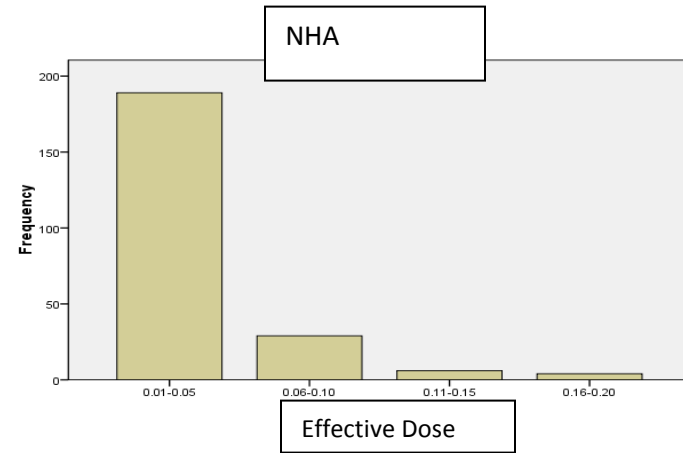
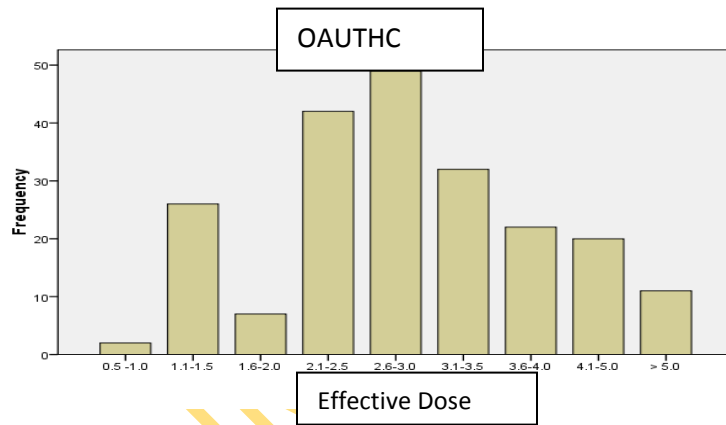
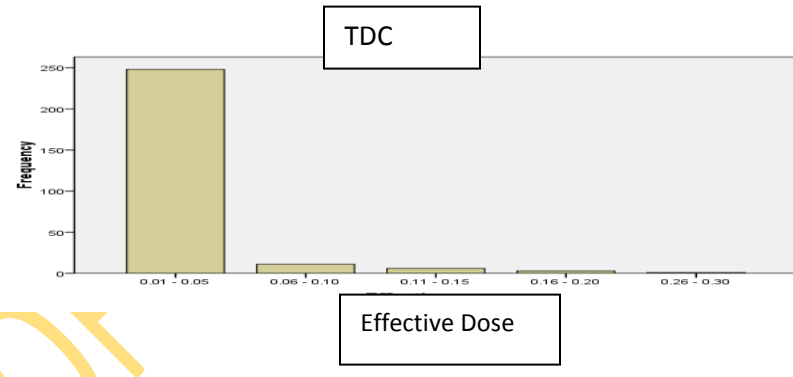
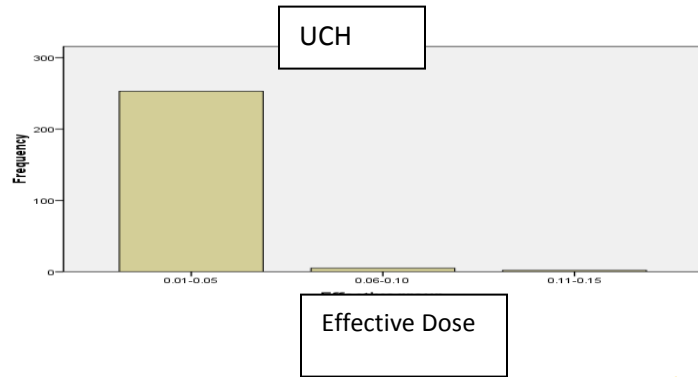

Fig. 4.2 contd.

(x) *Estimated risk distribution*

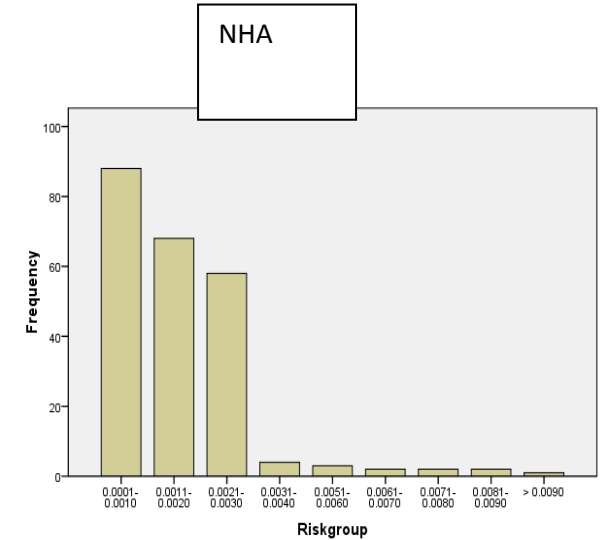
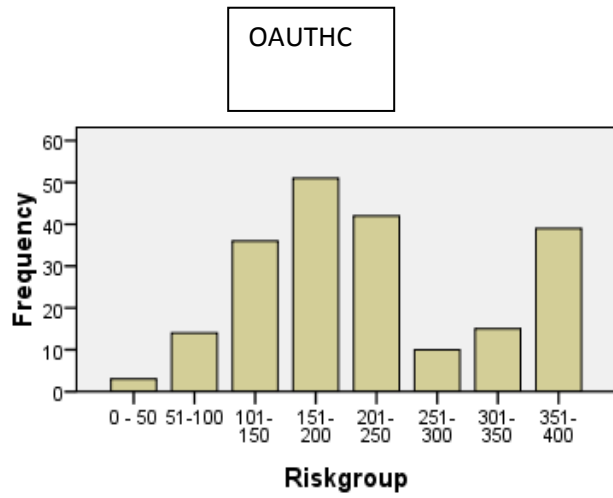
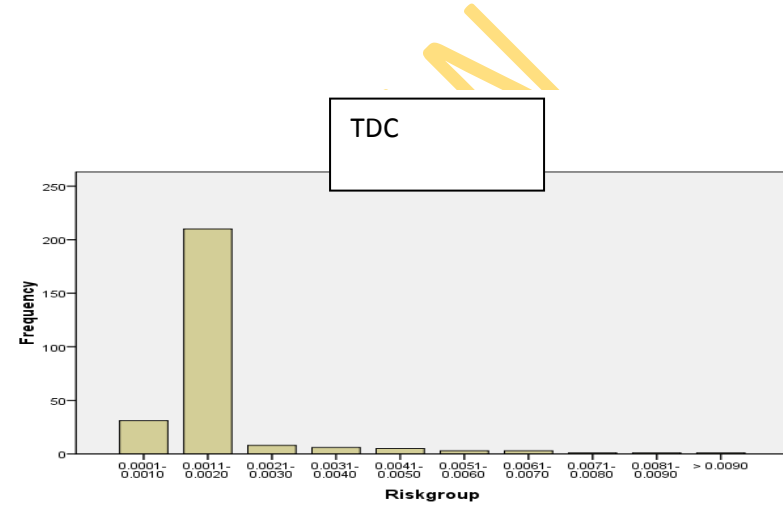
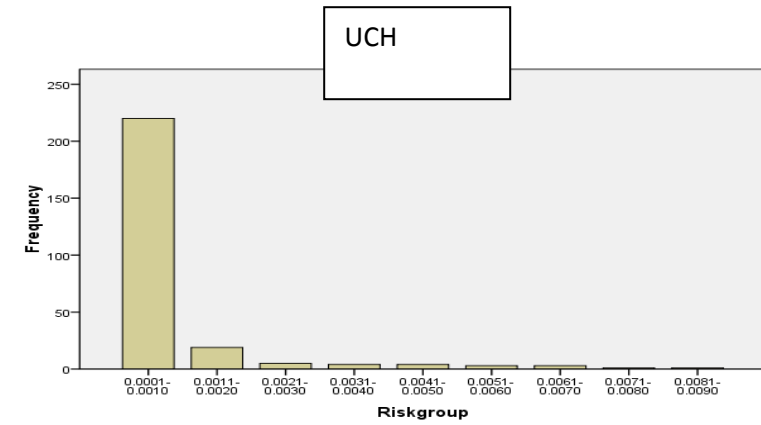

Table 4.9.7: Position of Radiographic Accessories with respect to X-ray tube/couch at the centres

	<i>Area of the room (cm x cm)</i>	<i>Operator stand (cm)</i>	<i>Leaded entrance door (cm)</i>	<i>Changing cubicle (cm)</i>	<i>Chest Stand (cm)</i>	<i>Cassette window (cm)</i>	<i>Dark room wall (cm)</i>
<i>Centre</i>							
UCH	400 x 800	180	350	300	174	215	215
TDC	350 x 500	200	205	100	160	135	135
OAUTHC	450 x 600	183	209	180	152	NA	NA
NHA	550 X 600	400	350	367	180	NA	NA